

# GUHRING



## MILLING TOOLS

5<sup>th</sup> Edition

# Vertical Integration allows for complete quality control



## ① SUBSTRATE

Guhring produces its own carbide, in multiple grades developed for specific application types

## ② TOOL GEOMETRIES

Our extensive R&D department creates and perfects innovative tool designs

## ③ MACHINE DIVISION

Guhring also produces tool grinding machines, vending machines, and testing equipment

## ④ COATINGS

Equipment and processes developed by Guhring provide superior PVD coatings for cutting tools

With a global network of manufacturing sites Guhring develops and produces precision tools for all the important markets. Users from the automotive industry, the aerospace industry or the machine tool and general industry rely on the trend-setting tools manufactured world-wide at the highest level to uniform quality standards.

With innovative technologies Guhring meets specific customer requirements from process proposal to series application of the precision tools – flexibly, promptly, globally. For this, experts are in action internationally looking after customers on site. Production, service and contact persons are available from one supplier world-wide.



28

PRODUCTION FACILITIES

47

SERVICE CENTERS

46

SUBSIDIARIES

## PRODUCTION AND SERVICE CENTERS

### GERMANY

Albstadt I  
Albstadt II  
Albstadt III  
Berlin/Precision Tools Production  
Berlin/Carbides  
Geislingen  
Gosheim  
Hörselberg/Eisenach  
Markt Erlbach  
Mindelheim  
Röhrsdorf/Chemnitz  
Saarbrücken  
Sigmaringen-Laiz  
Veldhoven/NL

### WORLD-WIDE

Australia  
Brazil  
Brazil  
China  
China  
China  
China  
France  
Great Britain  
India  
India  
India  
Indonesia  
Ireland  
Italy  
Diadema  
Joinville  
Changzhou  
Liaoning  
Liuzhou  
Hubei  
Bangalore  
Pune  
Gurgaon

Japan  
Korea  
Korea  
Korea  
Korea  
Korea  
Mexico  
Netherlands  
Austria  
Poland  
Poland  
Rumania  
Russia  
Sweden  
Spain  
Chungcheongnam-do  
Rizhao  
Choongnam  
Ulsan City  
Incheon  
Dabrowa Górnica  
Bielsko Biala

South Africa  
Taiwan  
Thailand  
Czech Republic  
Turkey  
Turkey  
Turkey  
Hungary  
USA  
USA  
USA  
USA  
USA  
Vietnam  
Belarus  
Istanbul  
Izmir  
Ankara  
Brookfield  
New Hudson  
Huntington Beach  
Bloomfield

















































































			Coating Temperature	Nano-hardness	Friction Coefficient	Thermal Stability
	<b>F</b>	<p><b>FIREX®</b></p> <p>Broadband coating based on TiAlN + TiN</p> <p>Multilayer, red-violet</p> <p>Higher hardness and temperature strength than TiN/ TiCN</p> <p>HSS: drilling/ milling/ tapping of steel, cast iron, Inconel, Ti, Ti-alloys</p> <p>Carbide: milling of steel, cast iron</p>	930° F 500° C	3000-3300 (HV 0.05)	0.50 (fetting)	1470° F 800° C
	<b>Y</b>	<p><b>nano-Si®</b></p> <p>TiAlSiN-based</p> <p>multilayer, nanostructured</p> <p>Carbide: Drilling, milling, reaming hardened steels and cast iron</p> <p>nano-Si was developed for hard machining. nanocomposite structure, based on TiAlN and silicon nitride (SiN), the coating has a very high micro hardness combined with good temperature strength.</p>	930° F 500° C	5500 (HV 0.05)	0.55 (fetting)	1470° F 800° C
	<b>a</b>	<p><b>nano-A™</b></p> <p>AlTiN-coating (Al-content between TiAlN and SuperA)</p> <p>Multilayer with nanostructured areas, blue-violet, high heat- and wear-resistance, very broad range of applications on carbide</p> <p>Carbide: milling, drilling, reaming steel, hardened steel, stainless steel, nickel-based alloys, cast iron</p> <p>nano-A™ is a further development of TiAlN and SuperA coatings.</p>	930° F 500° C	3800 (HV 0.05)	0.60 (fetting)	1650° F 900° C
	<b>A</b>	<p><b>Super-A®</b></p> <p>Al-rich AlTiN coating</p> <p>Monolayer, blue-anthracite</p> <p>High hardness and temperature strength</p> <p>Carbide: milling of hardened steel</p>	930° F 500° C	3800 (HV 0.05)	0.60 (fetting)	1650° F 900° C
		<p><b>Zenit</b></p> <p>Multilayer, nanostructured, TiAlZrN-based</p> <p>Aluminum content was reduced and substituted with zirconium (Zr)</p> <p>Drilling, milling titanium/Ti-alloys and aluminum alloys (&lt;10% Si)</p> <p>Zirconium presence in top layer reduces built-up edge, prolonging tool life in milling operations.</p>	930° F 500° C	2500 (HV 0.05)	0.40 (fetting)	1292° F 700° C
		<p><b>nano-Ra™</b></p> <p>TiN/ TiAlN-based with ZrN-top layer</p> <p>Multilayer, graded, pale gold</p> <p>TiN/ TiAlN-multilayer structure, with inert ZrN-top layer, opens new applications for drilling and milling softer steels</p> <p>Drilling/ Milling of softer steel with tendency to get built-up edge (e.g. ferritic steel)</p>	930° F 500° C	3300 (HV 0.05)	0.40 (fetting)	1470° F 800° C

# ISO Material Classifications

Suitability recommendations for every tool for the following application groups:

Application group	Material examples
<b>P</b>	Steel, high-alloyed steel
<b>M</b>	Stainless steel
<b>K</b>	Grey cast iron, spher, graphite/mall. cast iron
<b>N</b>	Aluminum and other non-ferrous metals
<b>S</b>	Special, super and titanium alloys
<b>H</b>	Hardened steel and chilled cast iron

<b>Application</b>	 Slotting	 Roughing	 Ramping	 Helix	 Plunging	 Finishing	 Copy Milling								
<b>Tool material</b>	 Polycrystalline diamond			 Finest grain solid carbide (carbide-UF)											
<b>Shank form</b>	 HA	 -HA	 HB	 -HB	 A	 B									
	to DIN 6535				to DIN 1835										
<b>Length</b>	 Stub	 Standard	 Long	 XL Long	 3xD XL Long	 4xD XL Long	 5xD XL Long								
<b>No. of cutting edges</b>	 2 No. of Flutes	 3 No. of Flutes	 3-6 No. of Flutes	 4 No. of Flutes	 4-5 No. of Flutes	 4-6 No. of Flutes	 4-8 No. of Flutes	 5 No. of Flutes	 5-6 No. of Flutes	 6 No. of Flutes	 6+ No. of Flutes				
<b>Helix angle</b>	 29°/30°/31° Helix angle	 30°/32° Helix angle	 35°/38° Helix angle	 36°/38° Helix angle	 36°/38°/37° Helix angle	 39°/40°/41° Helix angle	 40°/42° Helix angle	 41°/43°/45° Helix angle	 44°/45°/46° Helix angle	 0° Helix angle	 2-4° Helix angle	 20° Helix angle	 30° Helix angle	 45° Helix angle	 55° Helix angle
<b>Cutting edge form</b>	 45° Chamfer	 90° Chamfer	 R±.01 Radius	 R±.02 Radius	 R±.002 Radius	 R±.05 Radius	 R±.01 Radius	 R±.02 Radius	 R±.002 Radius	 R±.005 Radius	 60° Included Angle	 90° Included Angle	 120° Included Angle		
<b>Feed</b>	 Feed Dir.	 Feed Dir.	 Feed Dir.												
	for lateral feed		for lateral feed and ramping				for lateral feed, ramping, and plunging								
<b>Rake angle</b>	 15° Rake Angle	 7° Rake Angle	 0° Rake Angle	 3° Rake Angle	 4° Rake Angle	 5° Rake Angle	 6° Rake Angle	 7° Rake Angle	 8° Rake Angle	 9° Rake Angle	 10° Rake Angle	 11° Rake Angle	 12° Rake Angle	 15° Rake Angle	 25° Rake Angle



LOOK FOR THE GUHRING SELECT LOGO for specific offerings

For well over 100 years, the name Guhring has been associated with cutting tool innovation and quality. High-production facilities on every continent rely on Guhring technology to elevate their productivity, and manufacturers of high-precision parts know that Guhring provides consistent quality and performance.













































**GUHRING Select**, a category of stocked standard drills, taps and variable helix carbide end mills. This category is comprised of existing cutting tool series; current products which are already favorites in many machine shops across the United States.

Each **GUHRING Select** series has been chosen because of its versatility in a wide range of materials and machining operations, to provide you with a full compliment of quality drill, tap and end mill options at an economical price.

# Index - RF 100

Helix Angle	No. Flutes	Length	Tool illustration	Surface Finish	HA Str. Shank	HB Weldon	Unit	Page
<b>RF 100 DIVER end mills plunging and center cutting</b>				Carbide	Series No.	Series No.		
 Helix angle	 No. Flutes	 Standard		 nano-Si®	6872	6872	inch	36
 Helix angle	 No. Flutes	 Standard		 nano-Si®	6873	6873	inch	37
 Helix angle	 No. Flutes	 Standard		 nano-Si®	6797	6798	metric	38
 Helix angle	 No. Flutes	 Standard		 nano-Si®	6799	6800	metric	39
 Helix Angle	 No. Flutes	 Stub		 nano-Si®	6874	6874	inch	40
 Helix Angle	 No. Flutes	 Stub		 nano-Si®	6803	6804	metric	41
 Helix angle	 No. Flutes	 Standard		 nano-Si®	6757	6757	inch	42
 Helix angle	 No. Flutes	 Standard		 nano-Si®	6759	6759	inch	43
 Helix Angle	 No. Flutes	 Standard		 nano-Si®	6875	6875	inch	44
 Helix angle	 No. Flutes	 Standard		 nano-Si®	6737	6736	metric	45
 Helix Angle	 No. Flutes	 Standard		 nano-Si®	6801	6802	metric	46

# Index - RF 100

Helix Angle	No. Flutes	Length	Tool illustration	Surface Finish	HA Str. Shank	HB Weldon	Unit	Page
<b>RF 100 Speed end mills center cutting</b>				Carbide	Series No.	Series No.		
 Helix Angle 48°	 No. Flutes 4	 Standard		 nano-A™	6773	6773	inch	48
 Helix Angle 48°	 No. Flutes 4	 Standard		 Super-A®	6765	6760	metric	49
 Helix Angle 48°	 No. Flutes 4	 XL Long		 nano-A™	6774	6774	inch	50
 Helix Angle 48°	 No. Flutes 4	 XL Long		 Super-A®	6766	6761	metric	51
<b>RF 100 90° end mills center cutting, no corner chamfer</b>				Carbide	Series No.	Series No.		
 Helix Angle 39° 40° 41°	 No. Flutes 3	 Standard		 Bright	6775	6775	inch	54
 Helix Angle 40° 42°	 No. Flutes 4	 Standard		 Bright	6762		metric	55
 Helix Angle 45°	 No. Flutes 5	 Standard		 nano-A™	6776	6776	inch	56
 Helix Angle 45°	 No. Flutes 5	 XL Long		 nano-A™	6763		metric	57
 Helix Angle 40° 42°	 No. Flutes 4	 Standard		 nano-A™	6764		metric	58



# Index - RF 100

Helix Angle	No. Flutes	Length	Tool illustration	Surface Finish	HA Str. Shank	HB Weldon	Unit	Page
<b>RF 100 U High-performance end mills center cutting</b>								
 Helix Angle	 No. Flutes	 Stub				<b>3113</b>	<b>3099</b>	inch <b>60</b>
 Helix Angle	 No. Flutes	 Stub				<b>6706</b>	<b>3731</b>	metric <b>61</b>
 Helix Angle	 No. Flutes	 Standard				<b>3114</b>	<b>3100</b>	inch <b>62</b>
 Helix Angle	 No. Flutes	 Standard	 R			<b>3079</b>	<b>3079</b>	inch <b>63</b>
 Helix Angle	 No. Flutes	 Standard				<b>3736</b>	<b>3732</b>	metric <b>64</b>
 Helix Angle	 No. Flutes	 Standard	 R			<b>3872</b>	<b>3873</b>	metric <b>65</b>
 Helix Angle	 No. Flutes	 Long				<b>4250</b>	<b>4250</b>	inch <b>66</b>
 Helix Angle	 No. Flutes	 Long				<b>4251</b>	<b>4251</b>	inch <b>67</b>
 Helix Angle	 No. Flutes	 Long				<b>3837</b>	<b>3838</b>	metric <b>68</b>
 Helix Angle	 No. Flutes	 XL Long				<b>4252</b>	<b>4252</b>	inch <b>69</b>
 Helix Angle	 No. Flutes	 Long				<b>3839</b>	<b>3871</b>	metric <b>80</b>
 Helix Angle	 No. Flutes	 XL Long				--	<b>4253</b>	inch <b>71</b>
 Helix Angle	 No. Flutes	 XL Long				<b>3627</b>		metric <b>72</b>

# Index - RF 100

























































Helix Angle	No. Flutes	Length	Tool illustration	Surface Finish	HA Str. Shank	HB Weldon	Unit	Page
<b>RF 100 U High-performance end mills (3-fluted), center cutting</b>				Carbide	Series No.	Series No.		
 Helix angle	 No. Flutes	 Standard		 FIREX®	4254	4254	inch	73
 Helix angle	 No. Flutes	 Standard		 FIREX®	4255	4255	inch	74
 Helix angle	 No. Flutes	 Standard		 FIREX®	3893	3894	metric	75
 Helix angle	 No. Flutes	 Standard		 FIREX®	3891	3892	metric	76
<b>RF 100 U/HF High-performance roughing end mills center cutting</b>				Carbide	Series No.	Series No.		
 Helix angle	 No. Flutes	 Standard	 	 FIREX®	3082	3082	inch	82
 Helix angle	 No. Flutes	 Standard	 	 FIREX®	3507	3508	metric	83
 Helix angle	 No. Flutes	 Long		 FIREX®	4256	4256	inch	84
 Helix angle	 No. Flutes	 Long		 FIREX®	3509	3522	metric	85
 Helix angle	 No. Flutes	 XL Long		 FIREX®	3598	3600	metric	86
<b>RF 100 F High-performance end mills center cutting</b>				Carbide	Series No.	Series No.		
 Helix angle	 No. Flutes	 Standard		 FIREX®	3078	3078	inch	88
 Helix angle	 No. Flutes	 Standard		 FIREX®	3629	3630	metric	89
 Helix angle	 No. Flutes	 Standard		 FIREX®	--	3366	metric	90

# Index - RF 100

Helix Angle	No. Flutes	Length	Tool illustration	Surface Finish	HA Str. Shank	HB Weldon	Unit	Page
<b>RF 50 High-performance end mills center cutting</b>				Carbide	Series No.	Series No.		
 40° Helix Angle	 4 No. Flutes	 Stub		 FIREX®	3095	3095	inch	78
 40° Helix Angle	 4 No. Flutes	 Standard		 FIREX®	3096	3096	inch	79
<b>RF 100 VA High-performance end mills center cutting</b>				Carbide	Series No.	Series No.		
 36° 38° Helix angle	 4 No. Flutes	 Stub		 nano-A™	4257	4257	inch	92
 36° 38° Helix angle	 4 No. Flutes	 Stub		 nano-A™	3804	3805	metric	93
 36° 38° Helix angle	 4 No. Flutes	 Standard		 nano-A™	3080	3080	inch	94
 36° 38° Helix angle	 4 No. Flutes	 Standard		 nano-Si®	3053	3053	inch	95
 36° 38° Helix angle	 4 No. Flutes	 Standard		 nano-A™	3800	3803	metric	96
 36° 38° Helix angle	 4 No. Flutes	 Standard		 nano-A™	6700	6701	metric	97
 36° 38° Helix angle	 4 No. Flutes	 Long		 nano-A™	4260	4260	inch	98
 36° 38° Helix angle	 4 No. Flutes	 Long		 nano-A™	4258	4258	inch	99
 36° 38° Helix angle	 4 No. Flutes	 Long		 nano-A™	3806	3807	metric	100
 36° 38° Helix angle	 4 No. Flutes	 XL Long		 nano-A™	4259	4259	inch	101
<b>RF 100 VA High-performance ball nose end mills center cutting</b>				Carbide	Series No.	Series No.		
 36° 38° Helix angle	 4 No. Flutes	 Standard		 nano-A™	4261	4261	inch	102
 36° 38° Helix angle	 4 No. Flutes	 Standard		 nano-A™	6707	6708	metric	103

# Index - RF 100

































































Helix Angle	No. Flutes	Length	Tool illustration	Surface Finish	HA Str. Shank	HB Weldon	Unit	Page
<b>RF 100 VA/NF High-performance roughing end mills center cutting</b>				Carbide	Series No.	Series No.		
 Helix angle 36°/38°	 No. Flutes 4	 Standard		 nano-A™	3081	3081	inch	106
 Helix angle 36°/38°	 No. Flutes 4	 Standard		 nano-Si®	3060	3060	inch	107
 Helix angle 36°/38°	 No. Flutes 4	 Standard		 nano-A™	3696	3718	metric	108
 Helix angle 36°/38°	 No. Flutes 4	 Long		 nano-A™	4262	4262	inch	109
 Helix angle 36°/38°	 No. Flutes 4	 Long		 nano-A™	3733	3885	metric	110
<b>RF 100 A High-performance 4-flute end mills center cutting</b>				Carbide	Series No.	Series No.		
 Helix angle 40°/42°	 No. Flutes 4	 Standard		 Bright	3077	3077	inch	112
 Helix angle 40°/42°	 No. Flutes 4	 Standard		 Bright	3202	3319	metric	113
<b>RF 100 A High-performance 3-flute end mills center cutting</b>				Carbide	Series No.	Series No.		
 Helix angle 39°/40°/41°	 No. Flutes 3	 Standard		 Bright	4265	4265	inch	114
 Helix angle 39°/40°/41°	 No. Flutes 3	 Standard		 Bright	3472	6702	metric	115
 Helix angle 39°/40°/41°	 No. Flutes 3	 Standard		 Bright		6729	metric	116
 Helix angle 39°/40°/41°	 No. Flutes 3	 Long		 Bright	3473	6703	metric	117
 Helix angle 39°/40°/41°	 No. Flutes 3	 3xD XL Long		 Bright	6730	6731	metric	118
 Helix angle 39°/40°/41°	 No. Flutes 3	 4xD XL Long		 Bright	6732	6733	metric	119
 Helix angle 39°/40°/41°	 No. Flutes 3	 5xD XL Long		 Bright	6734	6735	metric	120

Helix Angle	No. Flutes	Length	Tool illustration	Surface Finish	HA Str. Shank	HB Weldon	Unit	Page
<b>RF 100 A/WF High-performance roughing end mills center cutting</b>				Carbide	Series No.	Series No.		
 30° 29° 31° Helix angle	 3 No. Flutes	 Standard		Bright	4266	4266	inch	122
 30° 29° 31° Helix angle	 3 No. Flutes	 Standard		Bright	3468	3469	metric	123
 30° 29° 31° Helix angle	 3 No. Flutes	 Long		Bright	3470	3471	metric	124
<b>RF 100 H High-performance end mills center cutting</b>				Carbide	Series No.	Series No.		
 40° 42° Helix angle	 4 No. Flutes	 Standard		 Y nano-Si®	3895	3896	metric	126
<b>RF 100 Ti High-performance end mills center cutting</b>				Carbide	Series No.	Series No.		
 35° 38° Helix Angle	 4 No. Flutes	 Standard		 A Super-A®	3876	3876	inch	128
 35° 38° Helix Angle	 4 No. Flutes	 Standard		 A Super-A®	3498	3499	metric	129
<b>Ratio end mills Superfinish RF 100 SF center cutting</b>				Carbide	Series No.	Series No.		
 45° Helix angle	 5 No. Flutes	 Standard		 F FIREX®	4263	4263	inch	132
 45° Helix angle	 5 No. Flutes	 Standard		 F FIREX®	6709	6710	metric	133
 45° Helix angle	 5 No. Flutes	 3xD XL Long		 F FIREX®	4264	4264	inch	134
 45° Helix angle	 5 No. Flutes	 3xD XL Long		 F FIREX®	3897	3898	metric	135
 44° 45° 46° Helix angle	 6 No. Flutes	 Standard		 F FIREX®	3115		inch	136
 44° 45° 46° Helix angle	 6 No. Flutes	 Standard		 F FIREX®	3631	3632	metric	137























































# Index - Diamond Tech

Helix Angle	No. Flutes	Length	Tool illustration	Surface Finish	HA Str. Shank	HB Weldon	Unit	Page
<b>DL 100 X2 High-performance PCD end mill for aluminum and composites</b>				PCD	Series No.	Series No.		
0° Helix angle	2 No. Flutes	Standard		PCD	<b>3867</b>		inch	<b>140</b>
0° Helix angle	3 No. Flutes	Standard		PCD	<b>3870</b>		inch	<b>141</b>
<b>Coolant fed high-performance PCD end mill for aluminum and composites</b>				PCD	Series No.	Series No.		
2-4° Helix angle	2 No. Flutes	Standard		PCD	<b>5492</b>		metric	<b>142</b>
2-4° Helix angle	2 No. Flutes	Long		PCD	<b>5493</b>		metric	<b>143</b>
2-4° Helix angle	3 No. Flutes	Standard		PCD	<b>5495</b>		metric	<b>144</b>
2-4° Helix angle	3 No. Flutes	Long		PCD	<b>5496</b>		metric	<b>145</b>
<b>Fiber-reinforced plastic end mills CR 100</b>				Carbide	Series No.	Series No.		
0° Helix angle	6+ No. Flutes	Standard		<b>Diamond</b>	--	--	inch	<b>147</b>
0° Helix angle	6+ No. Flutes	Standard		<b>Diamond</b>	--	--	inch	<b>147</b>
0° Helix angle	6+ No. Flutes	Standard		<b>Diamond</b>	<b>6717</b>		metric	<b>148</b>
0° Helix angle	6+ No. Flutes	Long		<b>Diamond</b>	<b>6718</b>		metric	<b>149</b>
0° Helix angle	6+ No. Flutes	Standard		<b>Diamond</b>	<b>6719</b>		metric	<b>150</b>
0° Helix angle	6+ No. Flutes	Standard		<b>Diamond</b>	<b>6720</b>		metric	<b>151</b>

# Index - Tech Line









Helix Angle	No. Flutes	Length	Tool illustration	Surface Finish	HA Str. Shank	HB Weldon	Unit	Page
<b>GH 100 U / Aero-Tech end mills (3-fluted), center cutting</b>				Carbide	Series No.	Series No.		
 45° Helix angle	 3 No. Flutes	 Stub		 FIREX®	3086		inch	155
 45° Helix angle	 3 No. Flutes	 Stub		 FIREX®	3540	3729	metric	156
 45° Helix angle	 3 No. Flutes	 Standard		 Bright	3172		inch	158
 45° Helix angle	 3 No. Flutes	 Standard		 FIREX®	3173		inch	158
 45° Helix angle	 3 No. Flutes	 Standard		 Bright	3203		metric	159
 45° Helix angle	 3 No. Flutes	 Standard		 FIREX®	3741		metric	159
<b>GA 200 A / Alumi-Tech end mills for aluminum (2-fluted), center cutting</b>				Carbide	Series No.	Series No.		
 45° Helix angle	 2 No. Flutes	 Stub		 Bright	3310	3126	metric	161
 45° Helix angle	 2 No. Flutes	 Standard		 Bright	3174		inch	162
 45° Helix angle	 2 No. Flutes	 Standard		 Super-A®	3874		inch	162
 45° Helix angle	 2 No. Flutes	 Standard		 Bright	3309	3059	metric	163
 45° Helix angle	 2 No. Flutes	 XL Long		 Bright	3175		inch	164
 45° Helix angle	 2 No. Flutes	 XL Long		 Super-A®	3875		inch	164
 45° Helix angle	 2 No. Flutes	 XL Long		 Bright	3358		metric	165

# Index - Tech Line

Helix Angle	No. Flutes	Length	Tool illustration	Surface Finish	HA Str. Shank	HB Weldon	Unit	Page
<b>GA 200 A / Alumi-Tech LR end mills (3-fluted) with corner radius</b>				Carbide	Series No.	Series No.		
 45° Helix angle	 3 No. Flutes	 Standard		 Bright	3367		metric	166
 45° Helix angle	 3 No. Flutes	 Standard		 Bright	3177		inch	167
 45° Helix angle	 3 No. Flutes	 Standard		 Super-A®	3877		inch	167
<b>GS 200 A / Rough-Tech Alu end mills coarse tooth</b>				Carbide	Series No.	Series No.		
 30° Helix angle	 3 No. Flutes	 Standard		 Bright	3184		inch	169
 30° Helix angle	 3 No. Flutes	 Standard		 Super-A®	3884		inch	169
 30° Helix angle	 3 No. Flutes	 Standard		 Bright		3364	metric	170
 30° Helix angle	 3 No. Flutes	 Standard		 Bright		3127	metric	170
<b>RS 100 U / Aero-Tech 48 end mills center cutting</b>				Carbide	Series No.	Series No.		
 30° Helix angle	 4-5 No. Flutes	 Standard		 FIREX®	3097		inch	173
 30° Helix angle	 4-5 No. Flutes	 Standard		 FIREX®	3887	3888	metric	174
<b>RS 100 F / Aero-Rough 56 end mills center cutting</b>				Carbide	Series No.	Series No.		
 45° Helix angle	 5-6 No. Flutes	 Standard		 FIREX®	3098		inch	175
 45° Helix angle	 5-6 No. Flutes	 Standard		 FIREX®	3889	3890	metric	176



# Index - Tech Line

Helix Angle	No. Flutes	Length	Tool illustration	Surface Finish	HA Str. Shank	HB Weldon	Unit	Page
<b>GS 100 U / Rough-Tech 48 end mills fine tooth</b>				Carbide	Series No.	Series No.		
 30° Helix angle	 4-5 No. Flutes	 Standard		 Bright	3186		inch	179
 30° Helix angle	 4-5 No. Flutes	 Standard		 FIREX®	3188		inch	180
 30° Helix angle	 4 No. Flutes	 Standard		 Super-A®	3886		inch	180
 30° Helix angle	 4-5 No. Flutes	 Standard		 Bright		3204	metric	181
 30° Helix angle	 4-5 No. Flutes	 Standard		 FIREX®		3723	metric	181
 30° Helix angle	 4 No. Flutes	 Standard		 FIREX®		3365	metric	182
<b>GS 100 H / Rough-Tech 56 end mills fine tooth</b>				Carbide	Series No.	Series No.		
 20° Helix angle	 4 No. Flutes	 Standard		 FIREX®	3189		inch	184
 20° Helix angle	 4 No. Flutes	 Standard		 nano-Si®		3682	metric	185
 20° Helix angle	 4 No. Flutes	 Long		 FIREX®	3190		inch	186
<b>GH 100 U / Finish-Tech 50</b>				Carbide	Series No.	Series No.		
 45° Helix angle	 6+ No. Flutes	 Standard		 Bright	3178		inch	188
 45° Helix angle	 6+ No. Flutes	 Standard		 FIREX®	3179		inch	188
 45° Helix angle	 6+ No. Flutes	 Standard		 nano-Si®	3084	3084	inch	189
 45° Helix angle	 6+ No. Flutes	 Standard	 R	 FIREX®	3091		inch	190
 45° Helix angle	 6+ No. Flutes	 Standard		 Bright	3311		metric	191

# Index - Tech Line

Helix Angle	No. Flutes	Length	Tool illustration	Surface Finish	HA Str. Shank	HB Weldon	Unit	Page
<b>GH 100 U / Finish-Tech 50</b> <i>(continued)</i>				Carbide	Series No.	Series No.		
45° Helix angle	6+ No. Flutes	Standard		<b>F</b> FIREX®	3689		metric	191
55° Helix angle	6+ No. Flutes	Standard		Bright		3019	metric	192
45° Helix angle	6+ No. Flutes	Standard		<b>F</b> FIREX®		3047	metric	192
45° Helix angle	6+ No. Flutes	Standard		Bright	3112		metric	193
45° Helix angle	6+ No. Flutes	Standard		<b>F</b> FIREX®	3563		metric	193
45° Helix angle	6+ No. Flutes	Long		Bright	3180		inch	194
45° Helix angle	6+ No. Flutes	Long		<b>F</b> FIREX®	3181		inch	194
45° Helix angle	6+ No. Flutes	XL Long		Bright	3312	3313	metric	195
45° Helix angle	6+ No. Flutes	XL Long		<b>F</b> FIREX®	3691	3693	metric	196
<b>GH 100 H / Finish-Tech 62 multi-flute end mills</b>				Carbide	Series No.	Series No.		
55° Helix angle	6+ No. Flutes	Standard		<b>Y</b> nano-Si®	3182		inch	199
55° Helix angle	6+ No. Flutes	Standard		<b>Y</b> nano-Si®	3715		metric	200
55° Helix angle	6+ No. Flutes	Long		<b>Y</b> nano-Si®	3183		inch	201
55° Helix angle	6+ No. Flutes	XL Long		<b>Y</b> nano-Si®	3716		metric	202
<b>GF 500 T HSC-profile cutters with Torus form</b>				Carbide	Series No.	Series No.		
30° Helix angle	2 No. Flutes	Standard		<b>Y</b> nano-Si®	3856		metric	205
30° Helix angle	2 No. Flutes	Long		<b>Y</b> nano-Si®	3859		metric	206
30° Helix angle	2 No. Flutes	Long		<b>Y</b> nano-Si®	3865		metric	207
30° Helix angle	2 No. Flutes	Long		<b>Y</b> nano-Si®	3863		metric	208
30° Helix angle	2 No. Flutes	XL Long		<b>Y</b> nano-Si®	3860		metric	209







































































# Index - Tech Line

Helix Angle	No. Flutes	Length	Tool illustration	Surface Finish	HA Str. Shank	HB Weldon	Unit	Page
<b>GF 500 B HSC-Ballnose profile cutters</b>				Carbide	Series No.	Series No.		
30° Helix angle	2 No. Flutes	Standard		nano-Si®	3854		metric	210
30° Helix angle	2 No. Flutes	Standard		nano-Si®	3848		metric	211
30° Helix angle	2 No. Flutes	Long		nano-Si®	3866		metric	212
30° Helix angle	2 No. Flutes	Long		nano-Si®	3855		metric	213
30° Helix angle	2 No. Flutes	XL Long		nano-Si®	3849		metric	214
30° Helix angle	2 No. Flutes	XL Long		nano-Si®	3853		metric	215
<b>HF 300 High Feed</b>				Carbide	Series No.	Series No.		
30° Helix Angle	4 No. Flutes	Standard		nano-Si®	6771		metric	216
30° Helix Angle	4 No. Flutes	XL Long		nano-Si®	6772		metric	217
<b>GF 300 T Trace-Tech hard profile cutters with Torus grind</b>				Carbide	Series No.	Series No.		
30° Helix angle	4 No. Flutes	Standard	R	nano-Si®	3361		metric	219
30° Helix angle	4 No. Flutes	Long	R	nano-Si®	3192		inch	220
30° Helix angle	4 No. Flutes	XL Long	R	nano-Si®	3362		metric	221
<b>GF 300 B Trace-Tech ballnose hard profile cutters</b>				Carbide	Series No.	Series No.		
30° Helix angle	2 No. Flutes	Standard		nano-Si®	3101		inch	222
30° Helix angle	2 No. Flutes	Standard		nano-Si®	3359		metric	223
30° Helix angle	2 No. Flutes	Long		nano-Si®	3191		inch	224
30° Helix angle	2 No. Flutes	XL Long		nano-Si®	3360		metric	225























































# Index - Pro Line

Helix Angle	No. Flutes	Length	Tool illustration	Surface Finish	HA Str. Shank	HB Weldon	Unit	Page
<b>Uni-Pro end mills (2-fluted)</b>				Carbide	Series No.	Series No.		
30° Helix angle	2 No. Flutes	Stub		FIREX®	3092		inch	228
30° Helix angle	2 No. Flutes	Stub		FIREX®	3633	3634	metric	229
30° Helix angle	2 No. Flutes	Standard		Bright	3146		inch	230
30° Helix angle	2 No. Flutes	Standard		FIREX®	3148		inch	230
30° Helix angle	2 No. Flutes	Standard		FIREX®	3087		inch	231
30° Helix angle	2 No. Flutes	Standard		Bright	3303		metric	232
30° Helix angle	2 No. Flutes	Standard		FIREX®	3676		metric	232
30° Helix angle	2 No. Flutes	Standard		Bright	3106		metric	233
30° Helix angle	2 No. Flutes	Standard		FIREX®	3561		metric	233
30° Helix angle	2 No. Flutes	Long		Bright	3147		inch	234
30° Helix angle	2 No. Flutes	Long		FIREX®	3149		inch	234
30° Helix angle	2 No. Flutes	Long		FIREX®	3088		inch	235
30° Helix angle	2 No. Flutes	XL Long		Bright	3011		metric	236
30° Helix angle	2 No. Flutes	XL Long		FIREX®	3021		metric	236







































































# Index - Pro Line

Helix Angle	No. Flutes	Length	Tool illustration	Surface Finish	HA Str. Shank	HB Weldon	Unit	Page
<b>Uni-Pro end mills (3-fluted)</b>				Carbide	Series No.	Series No.		
 30° Helix angle	 3 No. Flutes	 Stub		 FIREX®	3558	3719	metric	237
 30° Helix angle	 3 No. Flutes	 Standard		 Bright	3168		inch	238
 30° Helix angle	 3 No. Flutes	 Standard		 FIREX®	3170		inch	238
 30° Helix angle	 3 No. Flutes	 Standard		 Bright	3307		metric	239
 30° Helix angle	 3 No. Flutes	 Standard		 FIREX®	3677		metric	239
 30° Helix angle	 3 No. Flutes	 XL Long		 Bright	3169		inch	240
 30° Helix angle	 3 No. Flutes	 XL Long		 FIREX®	3171		inch	240
 30° Helix angle	 3 No. Flutes	 XL Long		 Bright	3314		metric	241
 30° Helix angle	 3 No. Flutes	 XL Long		 FIREX®	3680		metric	241
<b>Uni-Pro end mills (4-fluted)</b>				Carbide	Series No.	Series No.		
 30° Helix angle	 4 No. Flutes	 Stub		 FIREX®	3093		inch	242
 30° Helix angle	 4 No. Flutes	 Stub		 FIREX®	3637	3721	metric	243
 30° Helix angle	 4 No. Flutes	 Standard		 Bright	3150		inch	244
 30° Helix angle	 4 No. Flutes	 Standard		 FIREX®	3153		inch	244
 30° Helix angle	 4 No. Flutes	 Standard		 FIREX®	3089		inch	245































































# Index - Pro Line

Helix Angle	No. Flutes	Length	Tool illustration	Surface Finish	HA Str. Shank	HB Weldon	Unit	Page
<b>Uni-Pro end mills (4-fluted)</b> <i>(continued)</i>				Carbide	Series No.	Series No.		
 Helix angle	 No. Flutes	 Standard		 Bright	3304		metric	246
 Helix angle	 No. Flutes	 Standard		 FIREX®	3678		metric	246
 Helix angle	 No. Flutes	 Standard		 Bright	3111		metric	247
 Helix angle	 No. Flutes	 Standard		 FIREX®	3562		metric	247
 Helix angle	 No. Flutes	 Long		 Bright	3152		inch	248
 Helix angle	 No. Flutes	 Long		 FIREX®	3156		inch	248
 Helix angle	 No. Flutes	 XL Long		 Bright	3151		inch	249
 Helix angle	 No. Flutes	 XL Long		 FIREX®	3155		inch	249
 Helix angle	 No. Flutes	 XL Long		 FIREX®	3090		inch	250
 Helix angle	 No. Flutes	 XL Long		 Bright	3012		metric	251
 Helix angle	 No. Flutes	 XL Long		 FIREX®	3023		metric	251

# Index - Pro Line

Helix Angle	No. Flutes	Length	Tool illustration	Surface Finish	HA Str. Shank	HB Weldon	Unit	Page
<b>Uni-Pro ball nose end mills (2-fluted)</b>				Carbide	Series No.	Series No.		
 30° Helix angle	 2 No. Flutes	 Standard		 Bright	3157		inch	252
 30° Helix angle	 2 No. Flutes	 Standard		 FIREX®	3159		inch	252
 30° Helix angle	 2 No. Flutes	 Standard		 Bright	3308	3024	metric	253
 30° Helix angle	 2 No. Flutes	 Standard		 FIREX®	3679	3049	metric	254
 30° Helix angle	 2 No. Flutes	 Long		 Bright	3158		inch	255
 30° Helix angle	 2 No. Flutes	 Long		 FIREX®	3160		inch	255
 30° Helix angle	 2 No. Flutes	 XL Long		 Bright	3014		metric	256
 30° Helix angle	 2 No. Flutes	 XL Long		 FIREX®	3030		metric	256
<b>Uni-Pro ball nose end mills (4-fluted)</b>				Carbide	Series No.	Series No.		
 30° Helix angle	 4 No. Flutes	 Standard		 Bright	3161		inch	257
 30° Helix angle	 4 No. Flutes	 Standard		 FIREX®	3165		inch	257
 30° Helix angle	 4 No. Flutes	 Standard		 Bright	3306		metric	258
 30° Helix angle	 4 No. Flutes	 Standard		 FIREX®	3727		metric	258
 30° Helix angle	 4 No. Flutes	 Long		 Bright	3164		inch	259
 30° Helix angle	 4 No. Flutes	 Long		 FIREX®	3167		inch	259

# Index - Pro Line

Helix Angle	No. Flutes	Length	Tool illustration	Surface Finish	HA Str. Shank	HB Weldon	Unit	Page
<b>Uni-Pro ball nose end mills (4-fluted)</b> (continued)				Carbide	Series No.	Series No.		
 Helix angle 30°	 No. Flutes 4	 XL Long		 Bright	3162		inch	260
 Helix angle 30°	 No. Flutes 4	 XL Long		 FIREX®	3166		inch	260
 Helix angle 30°	 No. Flutes 4	 Standard		 Bright	3015		metric	261
 Helix angle 30°	 No. Flutes 4	 XL Long		 FIREX®	3043		metric	261
<b>Chamfering milling cutters</b>				Carbide	Series No.	Series No.		
 Helix angle 7°	 No. Flutes 4	 Standard	 	 A TiAlN	6711	6712	metric	262
 Helix angle 7°	 No. Flutes 4	 Standard	 	 A TiAlN	6713	3396	metric	263
 Helix angle 7°	 No. Flutes 4	 Standard	 	 Y nano-Si®	6784	6785	metric	264
 Helix angle 7°	 No. Flutes 4	 Standard	 	 A TiAlN	6714	6715	metric	265
 Helix angle 7°	 No. Flutes 6	 Standard	 	 A TiAlN	6786	6787	metric	266
<b>Corner rounding milling cutters</b>				Carbide	Series No.	Series No.		
 Helix angle 7°	 No. Flutes 4	 Standard	 	 F FIREX®	6788		metric	267
<b>Front/back de-burrer</b>								
 Helix angle 0°	 No. Flutes 4	 Long	 	 a nano-A™	495		metric	268



## STEEL

General steel grades from low to high tensile strength (500-1400 N/mm<sup>2</sup>); high-tensile heat-treatable and tool steels (- 48 HRC); hardened steels and chilled cast iron also above 63 HRC



## CAST IRON

Cast iron types such as grey cast iron (GG25), spheroidal graphite iron, malleable cast iron and cast steel alloys, abrasive special cast alloys



## ALUMINUM

Aluminum wrought alloys; high-tensile aluminum; silicon-containing cast aluminum



## STAINLESS STEEL

Stainless steels, acid- and heat-resistant alloys; titanium and nickel alloys; difficult-to-machine special alloys



# GUHRING

## IN-HOUSE TOOL RECONDITIONING

Utilizing the same high-precision CNC grinding machines that are used in Guhring's manufacturing plants, our Reconditioning Division is well equipped to restore standard and special carbide and PCD tooling to its original factory quality, condition and performance. High precision remanufacturing delivers longer reground tool life and often more regrinds per tool, resulting in significant cost savings in terms of both tooling and machining expenses. Guhring is able to provide factory reconditioning for our own drills, step drills, carbide end mills, and reamers. We can provide the same high-quality service for competitors' tooling as well.



# End Mills for Steels

# P



	RF 100 U	RF 100 F	RF 100 U/HF	RF 100 Diver	RF 100 Speed	RF 100 SF 90	RF 100 F 90	RF 50	RF 100 VA	RF 100 VA ballnose	RF 100 VA/NF	RF 100 Ti
start pg	60	88	82	36	48	132	58	78	92	102	106	128
# flutes	3, 4	4	4	3,4	4	5	4	4	4	4	4	4
Lengths	S/M/L/XL	M	M/L/XL	M	M/XL	M/XL	M	S	S/M/L/XL	S/M/L/XL	M/L	M
Radius	✓			✓								
Sharp Corner							✓					
Helix Angle	Variable	Variable	Variable	Variable	48°	45°	Variable	40°	Variable	Variable	Variable	Variable
Ballnose												
Coolant		✓		✓					✓			



	RF 100 S/F	Aero-Tech	Aero-Rough 48	Aero-Rough 56	Rough-Tech 56	Finish-Tech 50	2-flute universal	3-flute universal	4-flute universal	ballnose universal
		GH 100 U	RS 100 U	RS 100 F	GS 100 H	GH 100 U	Uni-Pro	Uni-Pro	Uni-Pro	Uni-Pro
start pg	132	155	173	175	184	188	228	237	242	252
# flutes	5	3	4-5	5-6	4	6+	2	3	4	2, 4
Lengths	M/XL	S/M	M	M	M/L	M/L/XL	S/M/L/XL	S/M/L/XL	S/M/L/XL	M/L/XL
Radius						✓	✓		✓	
Sharp Corner										
Helix Angle	45°	45°	45°	45°	20°	45°	30°	30°	30°	30°
Ballnose										✓
Coolant										

# End Mills for Stainless Steels

# M



	RF 100 VA	RF 100 VA ballnose	RF 100 VA/NF	RF 100 Diver	RF 100 Speed	RF 100 SF 90	RF 100 F 90	RF 100 F	RF 100 S/F
start pg	92	102	106	36	48	132	58	88	132
# flutes	4	4	4	3,4	4	5	4	4	5
Lengths	S/M/L/XL	S/M/L/XL	M/L	M	M/XL	M/XL	M	M	M/XL
Radius				✓					
Sharp Corner						✓	✓		
Helix Angle	Variable	Variable	Variable	Variable	48°	45°	Variable	Variable	45°
Ballnose									
Coolant	✓			✓				✓	



	Aero-Tech	Aero-Rough 48	Finish-Tech 50	2-flute universal	3-flute universal	4-flute universal	ballnose universal
	GH 100 U	RS 100 U	GH 100 U	Uni-Pro	Uni-Pro	Uni-Pro	Uni-Pro
start pg	155	173	188	228	237	242	252
# flutes	3	4-5	6+	2	3	4	2, 4
Lengths	S/M	M	M/L/XL	S/M/L/XL	S/M/L/XL	S/M/L/XL	M/L/XL
Radius			✓	✓		✓	
Sharp Corner							
Helix Angle	45°	45°	45°	30°	30°	30°	30°
Ballnose							✓
Coolant							

# End Mills for Cast Iron



	RF 100 U	RF 100 U/ HF	RF 100 Diver	RF 100 SF 90	RF 50	RF 100 H	RF 100 S/F	Aero-Tech	Aero-Rough 48
start pg	60	82	36	132	78	116	132	155	173
# flutes	3, 4	4	3,4	5	4	4	5	3	4-5
Lengths	S/M/L/XL	M/L/XL	M	M/XL	S	M	M/XL	S/M	M
Radius	✓		✓						
Sharp Corner									
Helix Angle	Variable	Variable	Variable	45°	40°	Variable	45°	45°	45°
Ballnose									
Coolant			✓						



	Aero-Rough 56	Rough-Tech 56	Finish-Tech 50	Finish-Tech 62	2-flute universal	3-flute universal	4-flute universal	ballnose universal
	RS 100 F	GS 100 H	GH 100 U	GH 100 H	Uni-Pro	Uni-Pro	Uni-Pro	Uni-Pro
start pg	175	184	188	199	228	237	242	252
# flutes	5-6	4	6+	6+	2	3	4	2, 4
Lengths	M	M/L	M/L/XL	M/L/XL	S/M/L/XL	S/M/L/XL	S/M/L/XL	M/L/XL
Radius			✓		✓		✓	
Sharp Corner								
Helix Angle	45°	20°	45°	55°	30°	30°	30°	30°
Ballnose								✓
Coolant								

# End Mills for Aluminum and Aluminum Alloys



	RF 100 A	RF 100 A 90	RF 100 A/ WF	GA 200 A	GS 100 A	GS 100 U	2-flute universal	3-flute universal	4-flute universal	ballnose universal
				Alumi-Tech	Rough-Tech Alu	Rough-Tech 48	Uni-Pro	Uni-Pro	Uni-Pro	Uni-Pro
start pg	112	50	122	166	169	179	228	237	242	252
# flutes	3, 4	3	3	2, 3	3	4-5	2	3	4	2, 4
Lengths	M/L	M	M/L	S/M/L/XL	M	M	S/M/L/XL	S/M/L/XL	S/M/L/XL	M/L/XL
Radius				✓	✓		✓		✓	
Sharp Corner		✓								
Helix Angle	Variable	Variable	Variable	45°	30°	30°	30°	30°	30°	30°
Ballnose										✓
Coolant				✓	✓	✓				

# End Mills for High-Temp and Ti-Alloys



	RF 100 Ti	RF 100 VA	RF 100 VA/NF	RF 100 Speed	RF 100 Diver	RF 100 SF 90	RF 100 F 90
start pg	128	92	106	48	36	132	58
# flutes	4	4	4	4	3,4	5	4
Lengths	M	S/M/L/XL	M/L	M/XL	M	M/XL	M
Radius					✓		
Sharp Corner						✓	✓
Helix Angle	Variable	Variable	Variable	48°	Variable	45°	Variable
Ballnose							
Coolant		✓			✓		



	RF 100 F	RF 100 S/F	Aero-Rough 56 RS 100 F
start pg	88	132	175
# flutes	4	5	5-6
Lengths	M	M/XL	M
Radius			
Sharp Corner			
Helix Angle	Variable	45°	45°
Ballnose			
Coolant			



# End Mills for Hardened Materials



	RF 100 H	Finish-Tech 62 GH 100 H	Rough-Tech 56 GS 100 H
start pg	126	199	184
# flutes	4	6+	4
Lengths	M	M/L/XL	M/L
Radius			
Sharp Corner			
Helix Angle	Variable	55°	20°
Ballnose			
Coolant			

# End Mills for Copy Milling / Die and Mold



	High Feed Mill HF 300	HSC Torus profile cutters GF 500 T	HSC ballnose profile cutters GF 500 B	Trace-Tec Hard profile cutters GF 300 T	Trace-Tec Ballnose profile cutters GF 300 B
start pg	216	205	210	219	222
# flutes	4	2	2	4	2
Lengths	M/XL	L/XL	M/L/XL	M/L	M/L/XL
Radius	✓	✓		✓	
Sharp Corner					
Helix Angle	30°	30°	30°	30°	30°
Ballnose			✓		✓
Coolant	✓				

# RF 100

HIGH-PERFORMANCE  
VARIABLE HELIX



Universally applicable for **all materials and milling strategies** for outstanding performance and tool life

- » special face geometry for drilling and ramping
- » optimized flute space
- » cutting edge preparation
- » nano-Si™ coating
- » with neck clearance
- » 4-fluted and 3-fluted option **NEW**
- » short length, 4-flute series **NEW**
- » with and without internal cooling **NEW**

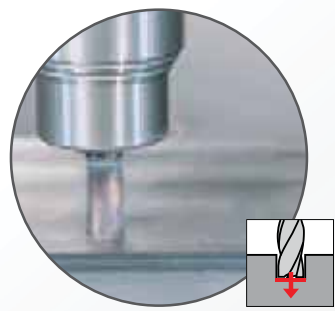

Drilling

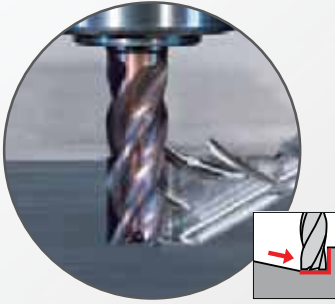

Ramping

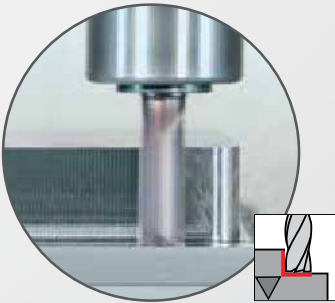

Roughing

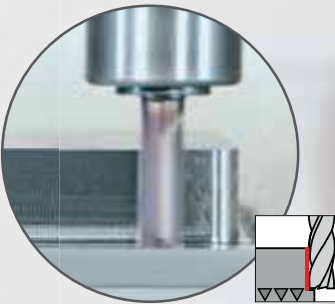

Finishing

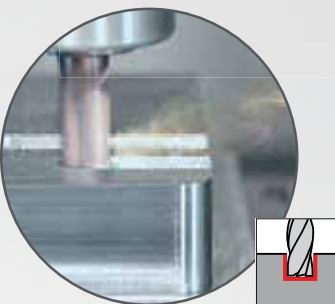

Slotting

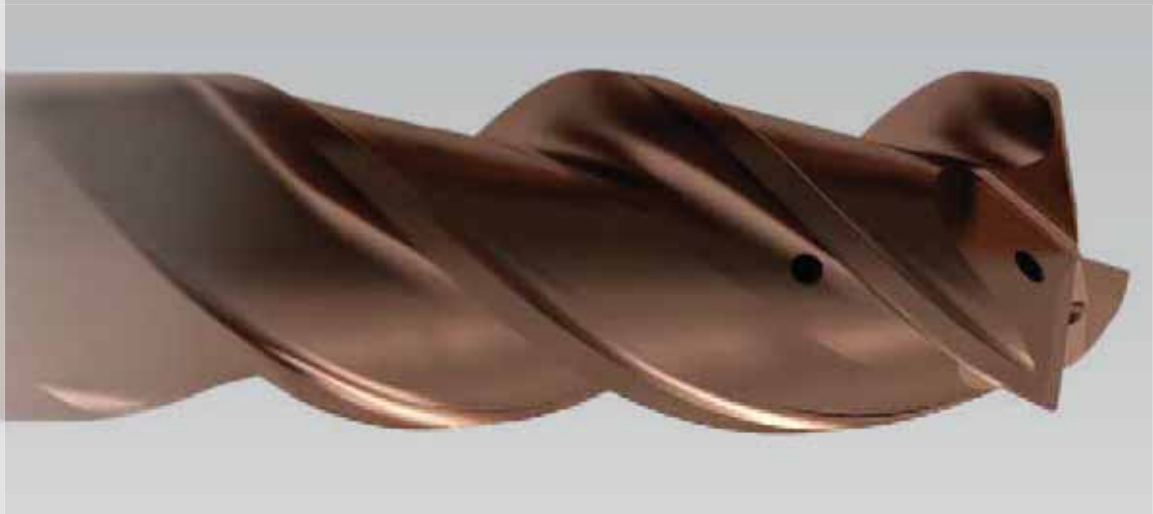

RF100  
**diver**  
END MILLS

# RF 100 ***diver*** END MILLS

# NEW

from

# GUHRING

## Extended program and coolant through end mills



### *Drilling and milling optimized coolant ducts*

Traditionally, drills have axial coolant ducts and milling cutters have radial coolant ducts. The coolant through RF 100 Diver offers **both** in order to optimize cooling and protection to the face and diameter when plunging. Guhring's decades of expertise in carbide production as well as tooling optimization ensures maximum efficiency of coolant lubrication, chip evacuation and tool stability.

- ▶ up to 40 % longer tool life
- ▶ for sticky materials
- ▶ stainless and heat-resistant materials
- ▶ for process reliability in drilling & plunging
- ▶ HPC machining

## *Choose the optimal Diver end mill for your application:*



### **3-fluted**

- ▶ for less powerful machines & less stable clamping conditions
- ▶ for turning machines & driven tools
- ▶ specially for slotting with smaller milling cutter diameters
- ▶ with and without coolant through



### **4-fluted**

- ▶ for stable machines & clamping
- ▶ high-performance milling with maximum cutting speeds
- ▶ with and without coolant through



### **4-fluted, short**

- ▶ for more stability when slotting
- ▶ up to 25 % higher feed rate
- ▶ reduced deflection
- ▶ without coolant through



### **4-fluted, corner radii**

- ▶ for pocketing and slotting
- ▶ multiple radii per diameter
- ▶ up to 25 % higher feed rate
- ▶ without coolant through

# RF 100 DIVER (3-flute) - Inch - Standard Length



## center cutting

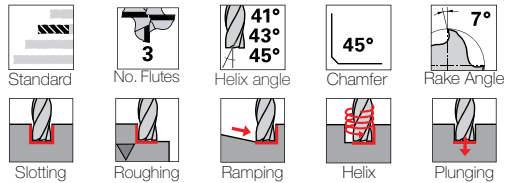

Tool material

**Solid Carbide**

Surface finish

nano-Si®

Series

**6872**

Application group	Material examples	Ideal for
P	Steel	●
M	Stainless steel	●
K	Cast iron	●
N	Aluminum	○
S	Ni / Ti alloys	●
H	Hardened steel	—

●=Optimal    ○=Secondary

Speed and Feed data found on page 286

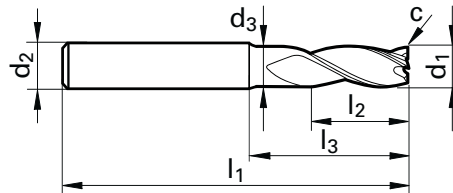

d1 h10	d2 h6	d3	l1	l2	l3	c	No. of Flutes	Code no.	EDP Number
inch	inch	inch	inch	inch	inch	inch x 45°			
1/8	1/8	0.117	2	1/4	3/4	0.002	3	3.170	9068720031700
3/16	3/16	0.180	2	3/8	3/4	0.003	3	4.760	9068720047600
1/4	1/4	0.238	2 1/2	1/2	7/8	0.004	3	6.350	9068720063500
5/16	5/16	0.300	2 1/2	1/2	7/8	0.005	3	7.940	9068720079400
3/8	3/8	0.363	2 1/2	5/8	7/8	0.006	3	9.520	9068720095200
1/2	1/2	0.480	3	5/8	1 1/8	0.007	3	12.700	9068720127000
5/8	5/8	0.605	3 1/2	3/4	1 1/2	0.007	3	15.870	9068720158700
3/4	3/4	0.730	4	1	1 3/4	0.009	3	19.050	9068720190500
1	1	0.960	4	1	1 5/8	0.011	3	25.400	9068720254000

# RF 100 DIVER (3-flute) - Inch - Standard Length



center cutting with coolant through



Standard



No. Flutes



Helix angle



Chamfer



Rake Angle



Slotting



Roughing



Ramping



Helix



Plunging



HA



HB

Tool material

Solid Carbide

Surface finish

nano-Si®

Series

6873

Application group	Material examples	Ideal for
P	Steel	●
M	Stainless steel	●
K	Cast iron	●
N	Aluminum	○
S	Ni / Ti alloys	●
H	Hardened steel	—

●=Optimal ○=Secondary

Speed and Feed data found on page 286

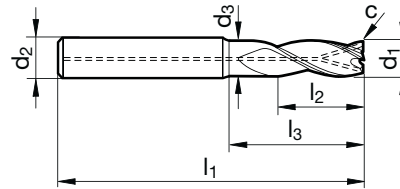

d1 h10	d2 h6	d3	l1	l2	l3	c	No. of Flutes	Code no.	EDP Number
inch	inch	inch	inch	inch	inch	inch x 45°			
1/4	1/4	0.238	2 1/2	1/2	7/8	0.004	3	6.350	9068730063500
5/16	5/16	0.300	2 1/2	1/2	7/8	0.005	3	7.940	9068730079400
3/8	3/8	0.363	2 1/2	5/8	7/8	0.006	3	9.520	9068730095200
1/2	1/2	0.480	3	5/8	1 1/8	0.007	3	12.700	9068730127000
5/8	5/8	0.605	3 1/2	3/4	1 1/2	0.007	3	15.870	9068730158700
3/4	3/4	0.730	4	1	1 3/4	0.009	3	19.050	9068730190500

# RF 100 DIVER (3-flute) - Metric - Standard Length



## center cutting

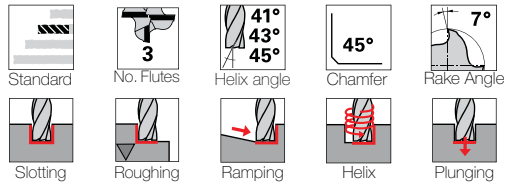

Tool material

**Solid Carbide**

Surface finish

nano-Si®

Series

6797

6798

Application group	Material examples	Ideal for
P	Steel	●
M	Stainless steel	●
K	Cast iron	●
N	Aluminum	○
S	Ni / Ti alloys	●
H	Hardened steel	—

●=Optimal    ○=Secondary

Speed and Feed data found on page 298

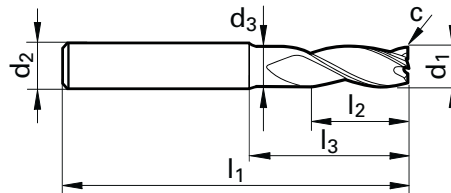

d1 h10	d2 h6	d3	l1	l2	l3	c	No. of Flutes	Code no.	EDP Number	
mm	mm	mm	mm	mm	mm	mm x 45°				
3.00	6.00	2.80	57	8.0	15.0	0.05	3	3.000	9067970030000	9067980030000
3.50	6.00	3.30	57	10.0	15.0	0.05	3	3.500	9067970035000	9067980035000
3.70	6.00	3.50	57	11.0	15.0	0.06	3	3.700	9067970037000	9067980037000
4.00	6.00	3.80	57	11.0	18.0	0.06	3	4.000	9067970040000	9067980040000
4.50	6.00	4.30	57	11.0	18.0	0.07	3	4.500	9067970045000	9067980045000
4.70	6.00	4.50	57	13.0	18.0	0.07	3	4.700	9067970047000	9067980047000
5.00	6.00	4.80	57	13.0	18.0	0.08	3	5.000	9067970050000	9067980050000
5.50	6.00	5.30	57	13.0	19.4	0.08	3	5.500	9067970055000	9067980055000
5.70	6.00	5.50	57	13.0	19.6	0.09	3	5.700	9067970057000	9067980057000
6.00	6.00	5.70	57	13.0	20.0	0.09	3	6.000	9067970060000	9067980060000
6.50	8.00	6.20	63	16.0	24.4	0.10	3	6.500	9067970065000	9067980065000
7.00	8.00	6.70	63	16.0	24.9	0.11	3	7.000	9067970070000	9067980070000
7.50	8.00	7.20	63	19.0	25.3	0.11	3	7.500	9067970075000	9067980075000
8.00	8.00	7.70	63	19.0	26.0	0.12	3	8.000	9067970080000	9067980080000
8.50	10.00	8.20	72	19.0	29.4	0.13	3	8.500	9067970085000	9067980085000
9.00	10.00	8.70	72	19.0	29.9	0.14	3	9.000	9067970090000	9067980090000
9.50	10.00	9.20	72	22.0	30.3	0.14	3	9.500	9067970095000	9067980095000
10.00	10.00	9.50	72	22.0	30.0	0.15	3	10.000	9067970100000	9067980100000
12.00	12.00	11.50	83	26.0	36.0	0.18	3	12.000	9067970120000	9067980120000
16.00	16.00	15.50	92	32.0	42.0	0.19	3	16.000	9067970160000	9067980160000
20.00	20.00	19.50	104	38.0	52.0	0.24	3	20.000	9067970200000	9067980200000

# RF 100 DIVER (3-flute) - Metric - Standard Length



center cutting with coolant through



Standard



No. Flutes



Helix angle



Chamfer



Rake Angle



Slotting



Roughing



Ramping



Helix



Plunging



HA



HB

Tool material

Solid Carbide

Surface finish

nano-Si®

Series

6799

6800

Application group	Material examples	Ideal for
P	Steel	●
M	Stainless steel	●
K	Cast iron	●
N	Aluminum	○
S	Ni / Ti alloys	●
H	Hardened steel	—

●=Optimal    ○=Secondary

Speed and Feed data found on page 298

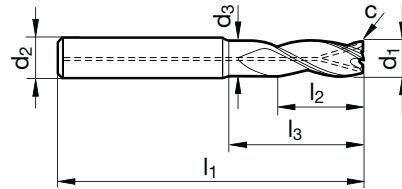

d1 h10	d2 h6	d3	l1	l2	l3	c	No. of Flutes	Code no.	EDP Number	
mm	mm	mm	mm	mm	mm	mm x 45°				
6.00	6.00	5.70	57	13.0	20.0	0.09	3	6.000	9067990060000	9068000060000
8.00	8.00	7.70	63	19.0	26.0	0.12	3	8.000	9067990080000	9068000080000
10.00	10.00	9.50	72	22.0	30.0	0.15	3	10.000	9067990100000	9068000100000
12.00	12.00	11.50	83	26.0	36.0	0.18	3	12.000	9067990120000	9068000120000
16.00	16.00	15.50	92	32.0	42.0	0.19	3	16.000	9067990160000	9068000160000



# RF 100 DIVER (4-flute) - Inch - Short Length



## center cutting

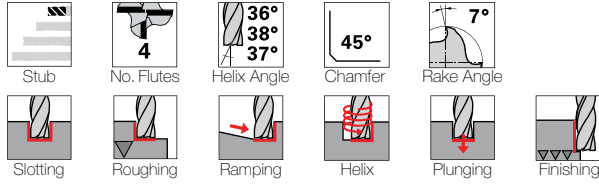

Tool material

**Solid Carbide**

Surface finish

nano-Si®

Series

**6874**

Application group	Material examples	Ideal for
<b>P</b>	Steel	●
<b>M</b>	Stainless steel	●
<b>K</b>	Cast iron	●
<b>N</b>	Aluminum	○
<b>S</b>	Ni / Ti alloys	●
<b>H</b>	Hardened steel	—

●=Optimal    ○=Secondary

Speed and Feed data found on page 286

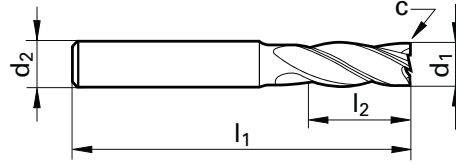

d1 h10	d2 h6	l1	l2	c	No. of Flutes	Code no.	EDP Number
inch	inch	inch	inch	inch x 45°			
1/4	1/4	2	1/2	0.002	4	6.350	<b>9068740063500</b>
5/16	5/16	2	1/2	0.003	4	7.940	<b>9068740079400</b>
3/8	3/8	2	5/8	0.004	4	9.520	<b>9068740095200</b>
7/16	7/16	2 1/2	5/8	0.004	4	11.110	<b>9068740111100</b>
1/2	1/2	2 1/2	5/8	0.005	4	12.700	<b>9068740127000</b>
5/8	5/8	3	3/4	0.006	4	15.870	<b>9068740158700</b>
3/4	3/4	3	1	0.007	4	19.050	<b>9068740190500</b>

# RF 100 DIVER (4-flute) - Metric - Short Length



## center cutting

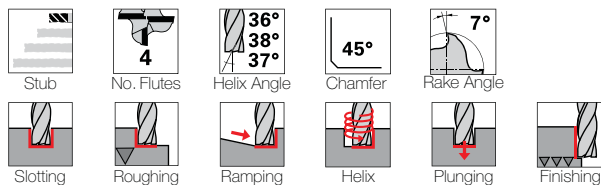

Tool material

Solid Carbide

Surface finish

nano-Si®

Series

6803

6804

Application group	Material examples	Ideal for
P	Steel	●
M	Stainless steel	●
K	Cast iron	●
N	Aluminum	○
S	Ni / Ti alloys	●
H	Hardened steel	—

●=Optimal ○=Secondary

Speed and Feed data found on page 298

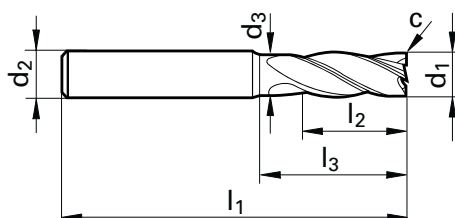

d1 h10	d2 h6	d3	l1	l2	l3	c	No. of Flutes	Code no.	EDP Number	
mm	mm	mm	mm	mm	mm	mm x 45°				
3.00	6.00	2.80	50	5.0	12.0	0.03	4	3.000	9068030030000	9068040030000
3.70	6.00	3.50	54	8.0	12.0	0.04	4	3.700	9068030037000	9068040037000
4.00	6.00	3.80	54	8.0	15.0	0.04	4	4.000	9068030040000	9068040040000
4.70	6.00	4.50	54	9.0	15.0	0.05	4	4.700	9068030047000	9068040047000
5.00	6.00	4.80	54	9.0	15.0	0.05	4	5.000	9068030050000	9068040050000
5.70	6.00	5.50	54	10.0	16.6	0.06	4	5.700	9068030057000	9068040057000
6.00	6.00	5.70	54	10.0	17.0	0.06	4	6.000	9068030060000	9068040060000
7.00	8.00	6.70	58	11.0	19.9	0.07	4	7.000	9068030070000	9068040070000
7.70	8.00	7.40	58	12.0	20.5	0.08	4	7.700	9068030077000	9068040077000
8.00	8.00	7.70	58	12.0	21.0	0.08	4	8.000	9068030080000	9068040080000
9.00	10.00	8.70	66	13.0	23.9	0.09	4	9.000	9068030090000	9068040090000
9.70	10.00	9.40	66	14.0	24.5	0.10	4	9.700	9068030097000	9068040097000
10.00	10.00	9.50	66	14.0	24.0	0.10	4	10.000	9068030100000	9068040100000
11.70	12.00	11.20	73	16.0	25.3	0.12	4	11.700	9068030117000	9068040117000
12.00	12.00	11.50	73	16.0	26.0	0.12	4	12.000	9068030120000	9068040120000
15.60	16.00	15.10	82	22.0	31.2	0.16	4	15.600	9068030156000	9068040156000
16.00	16.00	15.50	82	22.0	32.0	0.16	4	16.000	9068030160000	9068040160000
19.00	20.00	18.50	92	26.0	38.7	0.19	4	19.000	9068030190000	9068040190000
20.00	20.00	19.50	92	26.0	40.0	0.20	4	20.000	9068030200000	9068040200000

# RF 100 DIVER (4-flute) - Inch - Standard Length



## center cutting

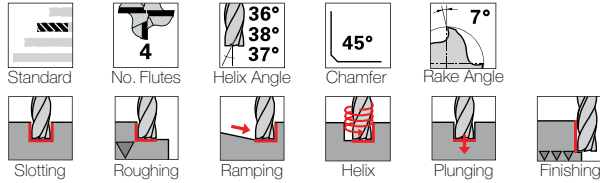

Tool material

**Solid Carbide**

Surface finish

nano-Si®

Series

**6757**

Application group	Material examples	Ideal for
<b>P</b>	Steel	●
<b>M</b>	Stainless steel	●
<b>K</b>	Cast iron	●
<b>N</b>	Aluminum	○
<b>S</b>	Ni / Ti alloys	●
<b>H</b>	Hardened steel	—

●=Optimal    ○=Secondary

Speed and Feed data found on page 286

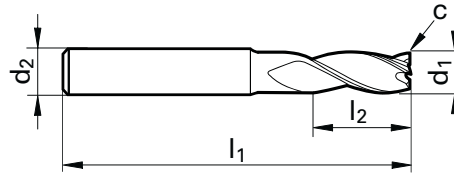

d1 h10	d2 h6	l1	l2	c	No. of Flutes	Code no.	EDP Number
inch	inch	inch	inch	inch x 45°			
1/8	1/8	1 1/2	1/4	0.001	4	3.170	9067570031700
3/16	3/16	2	3/8	0.002	4	4.760	9067570047600
1/4	1/4	2 1/2	1/2	0.002	4	6.350	9067570063500
5/16	5/16	2 1/2	3/4	0.003	4	7.940	9067570079400
3/8	3/8	2 1/2	7/8	0.004	4	9.520	9067570095200
7/16	7/16	2 3/4	7/8	0.004	4	11.110	9067570111100
1/2	1/2	3 1/2	1	0.005	4	12.700	9067570127000
5/8	5/8	3 1/2	1 1/4	0.006	4	15.870	9067570158700
3/4	3/4	4	1 1/2	0.007	4	19.050	9067570190500
1	1	5	1 1/2	0.010	4	25.400	9067570254000

# RF 100 DIVER (4-flute) - Inch - Standard Length



center cutting - with corner radius options

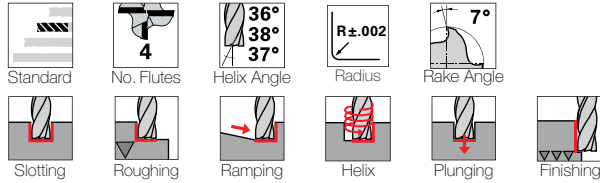

Tool material

Solid Carbide

Surface finish

nano-Si®

Series

6759

Application group	Material examples	Ideal for
P	Steel	●
M	Stainless steel	●
K	Cast iron	●
N	Aluminum	○
S	Ni / Ti alloys	●
H	Hardened steel	—

●=Optimal ○=Secondary

Speed and Feed data found on page 286

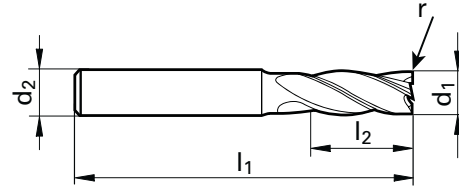

d1 h10	d2 h6	l1	l2	corner radius	No. of Flutes	Code no.	EDP Number
1/8	1/8	1 1/2	1/4	0.015	4	3.172	9067590031720
1/8	1/8	1 1/2	1/4	0.031	4	3.174	9067590031740
3/16	3/16	2	3/8	0.015	4	4.762	9067590047620
3/16	3/16	2	3/8	0.031	4	4.764	9067590047640
1/4	1/4	2 1/2	1/2	0.015	4	6.352	9067590063520
1/4	1/4	2 1/2	1/2	0.031	4	6.354	9067590063540
1/4	1/4	2 1/2	1/2	0.062	4	6.356	9067590063560
5/16	5/16	2 1/2	3/4	0.015	4	7.942	9067590079420
5/16	5/16	2 1/2	3/4	0.031	4	7.944	9067590079440
5/16	5/16	2 1/2	3/4	0.062	4	7.946	9067590079460
3/8	3/8	2 1/2	7/8	0.015	4	9.522	9067590095220
3/8	3/8	2 1/2	7/8	0.031	4	9.524	9067590095240
3/8	3/8	2 1/2	7/8	0.062	4	9.526	9067590095260
3/8	3/8	2 1/2	7/8	0.090	4	9.527	9067590095270
1/2	1/2	3 1/2	1	0.015	4	12.702	9067590127020
1/2	1/2	3 1/2	1	0.031	4	12.704	9067590127040
1/2	1/2	3 1/2	1	0.062	4	12.706	9067590127060
1/2	1/2	3 1/2	1	0.090	4	12.707	9067590127070
1/2	1/2	3 1/2	1	0.125	4	12.709	9067590127090
5/8	5/8	3 1/2	1 1/4	0.031	4	15.874	9067590158740
5/8	5/8	3 1/2	1 1/4	0.062	4	15.876	9067590158760
5/8	5/8	3 1/2	1 1/4	0.090	4	15.877	9067590158770
5/8	5/8	3 1/2	1 1/4	0.125	4	15.879	9067590158790
3/4	3/4	4	1 1/2	0.031	4	19.054	9067590190540
3/4	3/4	4	1 1/2	0.062	4	19.056	9067590190560
3/4	3/4	4	1 1/2	0.090	4	19.057	9067590190570
3/4	3/4	4	1 1/2	0.125	4	19.059	9067590190590
3/4	3/4	4	1 1/2	0.190	4	19.050	9067590190500
3/4	3/4	4	1 1/2	0.250	4	19.051	9067590190510
1	1	5	1 1/2	0.031	4	25.404	9067590254040
1	1	5	1 1/2	0.062	4	25.406	9067590254060
1	1	5	1 1/2	0.090	4	25.407	9067590254070
1	1	5	1 1/2	0.125	4	25.409	9067590254090
1	1	5	1 1/2	0.190	4	25.400	9067590254000
1	1	5	1 1/2	0.250	4	25.401	9067590254010

# RF 100 DIVER (4-flute) - Inch - Standard Length



center cutting with coolant through

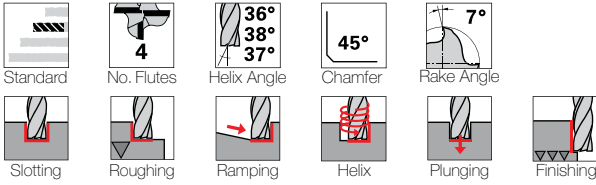

Tool material

**Solid Carbide**

Surface finish

nano-Si®

Series

**6875**

Application group	Material examples	Ideal for
<b>P</b>	Steel	●
<b>M</b>	Stainless steel	●
<b>K</b>	Cast iron	●
<b>N</b>	Aluminum	○
<b>S</b>	Ni / Ti alloys	●
<b>H</b>	Hardened steel	—

●=Optimal    ○=Secondary

Speed and Feed data found on page 286

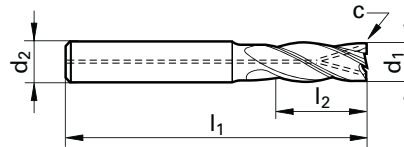

d1 h10	d2 h6	l1	l2	c	No. of Flutes	Code no.	EDP Number
inch	inch	inch	inch	inch x 45°			
1/4	1/4	2 1/2	1/2	0.002	4	6.350	9068750063500
5/16	5/16	2 1/2	3/4	0.003	4	7.940	9068750079400
3/8	3/8	2 1/2	7/8	0.004	4	9.520	9068750095200
1/2	1/2	3 1/2	1	0.005	4	12.700	9068750127000
5/8	5/8	3 1/2	1 1/4	0.006	4	15.870	9068750158700
3/4	3/4	4	1 1/2	0.007	4	19.050	9068750190500

# RF 100 DIVER (4-flute) - Metric - Standard Length



## center cutting

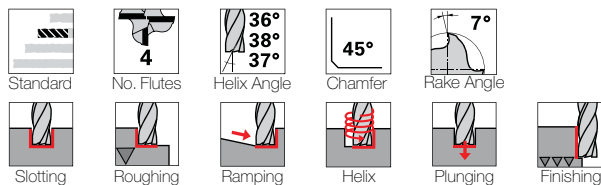

Tool material

Solid Carbide

Surface finish

nano-Si®

Series

6737

6736

Application group	Material examples	Ideal for
P	Steel	●
M	Stainless steel	●
K	Cast iron	●
N	Aluminum	○
S	Ni / Ti alloys	●
H	Hardened steel	—

●=Optimal ○=Secondary

Speed and Feed data found on page 298

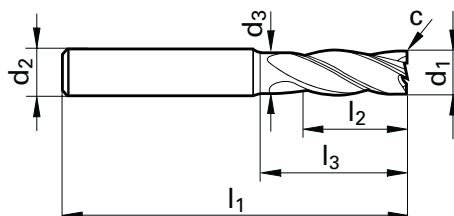

d1 h10	d2 h6	d3	l1	l2	l3	c	No. of Flutes	Code no.	EDP Number	
mm	mm	mm	mm	mm	mm	mm x 45°				
4.000	6.000	3.800	57.00	11.00	18.00	0.04	4	4.000	9067370040000	9067360040000
5.000	6.000	4.800	57.00	13.00	18.00	0.05	4	5.000	9067370050000	9067360050000
5.700	6.000	5.500	57.00	13.00	20.00	0.06	4	5.700	9067370057000	9067360057000
6.000	6.000	5.700	57.00	13.00	20.00	0.06	4	6.000	9067370060000	9067360060000
7.700	8.000	7.400	63.00	19.00	26.00	0.08	4	7.700	9067370077000	9067360077000
8.000	8.000	7.700	63.00	19.00	26.00	0.08	4	8.000	9067370080000	9067360080000
9.700	10.000	9.400	72.00	22.00	30.00	0.10	4	9.700	9067370097000	9067360097000
10.000	10.000	9.500	72.00	22.00	30.00	0.10	4	10.000	9067370100000	9067360100000
11.700	12.000	11.200	83.00	26.00	36.00	0.12	4	11.700	9067370117000	9067360117000
12.000	12.000	11.500	83.00	26.00	36.00	0.12	4	12.000	9067370120000	9067360120000
13.700	14.000	13.200	83.00	26.00	36.00	0.14	4	13.700	9067370137000	9067360137000
14.000	14.000	13.500	83.00	26.00	36.00	0.14	4	14.000	9067370140000	9067360140000
15.600	16.000	15.100	92.00	32.00	42.00	0.16	4	15.600	9067370156000	9067360156000
16.000	16.000	15.500	92.00	32.00	42.00	0.16	4	16.000	9067370160000	9067360160000
19.500	20.000	19.000	104.00	38.00	52.00	0.20	4	19.500	9067370195000	9067360195000
20.000	20.000	19.500	104.00	38.00	52.00	0.20	4	20.000	9067370200000	9067360200000

# RF 100 DIVER (4-flute) - Metric - Standard Length



center cutting with coolant through

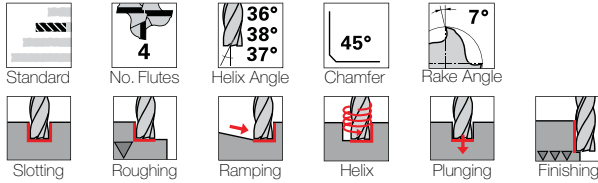

Tool material

**Solid Carbide**

Surface finish

nano-Si®

Series

**6801**

**6802**

Application group	Material examples	Ideal for
<b>P</b>	Steel	●
<b>M</b>	Stainless steel	●
<b>K</b>	Cast iron	●
<b>N</b>	Aluminum	○
<b>S</b>	Ni / Ti alloys	●
<b>H</b>	Hardened steel	—

●=Optimal    ○=Secondary

Speed and Feed data found on page 298

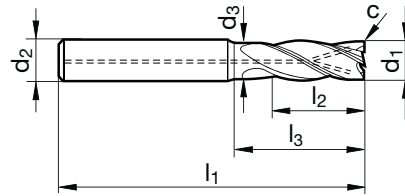

d1 h10	d2 h6	d3	l1	l2	l3	c	No. of Flutes	Code no.	EDP Number	
mm	mm	mm	mm	mm	mm	mm x 45°				
6.00	6.00	5.70	57	13.0	20.0	0.06	4	6.000	9068010060000	9068020060000
8.00	8.00	7.70	63	19.0	26.0	0.08	4	8.000	9068010080000	9068020080000
10.00	10.00	9.50	72	22.0	30.0	0.10	4	10.000	9068010100000	9068020100000
12.00	12.00	11.50	83	26.0	36.0	0.12	4	12.000	9068010120000	9068020120000
16.00	16.00	15.50	92	32.0	42.0	0.16	4	16.000	9068010160000	9068020160000
20.00	20.00	19.50	104	38.0	52.0	0.20	4	20.000	9068010200000	9068020200000
25.00	25.00	24.00	121	45.0	63.0	0.25	4	25.000	9068010250000	9068020250000

# RF 100 Speed

HPC milling in steels, stainless steels,  
and Ni & Ti alloys

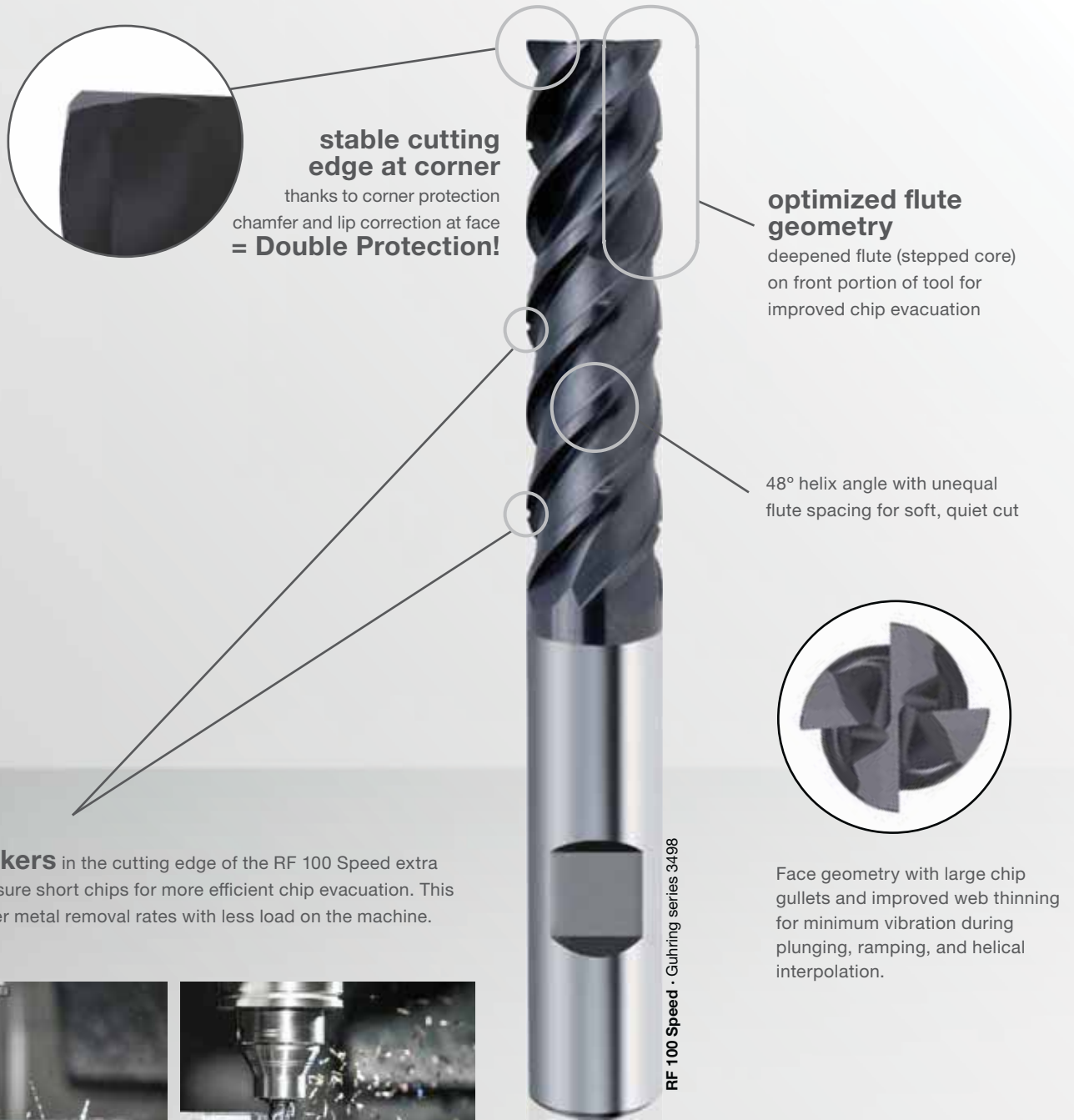

**Chip breakers** in the cutting edge of the RF 100 Speed extra length tools ensure short chips for more efficient chip evacuation. This allows for higher metal removal rates with less load on the machine.



Chip formation using a conventional end mill (left) versus the RF 100 Speed (right).



# RF 100 Speed (4-flute) - Inch - Standard Length

a

## center cutting

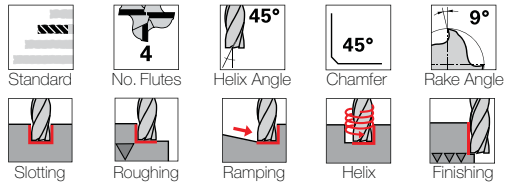

Tool material

**Solid Carbide**

Surface finish

nano-A™

Series

**6773**

Application group	Material examples	Ideal for
P	Steel	●
M	Stainless steel	●
K	Cast iron	—
N	Aluminum	—
S	Ni / Ti alloys	●
H	Hardened steel	—

●=Optimal ○=Secondary

Speed and Feed data found on page 288

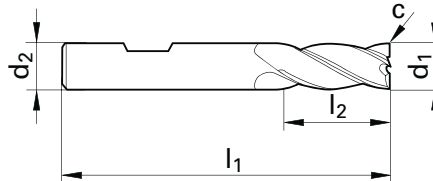

d1 h10	d2 h6	l1	l2	c	No. of Flutes	Code no.	EDP Number
inch	inch	inch	inch	inch x 45°			
1/8	1/8	1 1/2	3/8	0.002	4	3.170	9067730031700
3/16	3/16	2	5/8	0.002	4	4.760	9067730047600
1/4	1/4	2 1/2	3/4	0.004	4	6.350	9067730063500
5/16	5/16	2 1/2	13/16	0.005	4	7.940	9067730079400
3/8	3/8	2 1/2	1	0.006	4	9.520	9067730095200
1/2	1/2	3 1/2	1 1/4	0.007	4	12.700	9067730127000
5/8	5/8	3 1/2	1 1/4	0.012	4	15.870	9067730158700
3/4	3/4	4	1 1/2	0.012	4	19.050	9067730190500

# RF 100 Speed (4-flute) - Metric - Standard Length



## center cutting

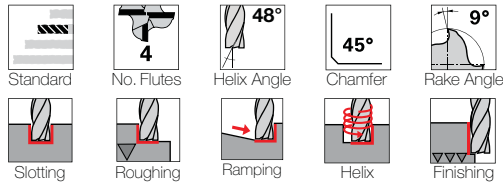

Tool material

Solid Carbide

Surface finish

Super-A™

Series

6765

6760

Application group	Material examples	Ideal for
P	Steel	●
M	Stainless steel	●
K	Cast iron	—
N	Aluminum	—
S	Ni / Ti alloys	●
H	Hardened steel	—

●=Optimal ○=Secondary

Speed and Feed data found on page 300

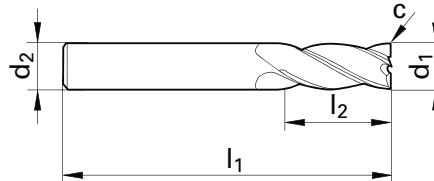

d1 h10	d2 h6	l1	l2	c	No. of Flutes	Code no.	EDP Number	
mm	mm	mm	mm	mm x 45°				
3.000	6.000	57.00	8.00	0.045	4	3.000	9067650030000	9067600030000
4.000	6.000	57.00	11.00	0.060	4	4.000	9067650040000	9067600040000
5.000	6.000	57.00	13.00	0.075	4	5.000	9067650050000	9067600050000
6.000	6.000	57.00	15.00	0.090	4	6.000	9067650060000	9067600060000
8.000	8.000	63.00	20.00	0.120	4	8.000	9067650080000	9067600080000
10.000	10.000	72.00	24.00	0.150	4	10.000	9067650100000	9067600100000
12.000	12.000	83.00	28.00	0.180	4	12.000	9067650120000	9067600120000
16.000	16.000	92.00	36.00	0.240	4	16.000	9067650160000	9067600160000
20.000	20.000	104.00	45.00	0.300	4	20.000	9067650200000	9067600200000

# RF 100 Speed (4-flute) - Inch - XL Long Length



## center cutting - with chip breaker

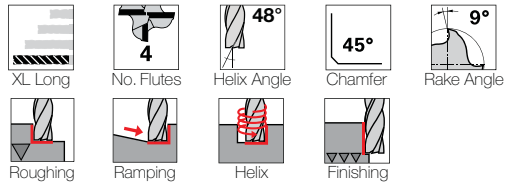

Tool material

**Solid Carbide**

Surface finish

nano-A™

Series

**6774**

Application group	Material examples	Ideal for
<b>P</b>	Steel	●
<b>M</b>	Stainless steel	●
<b>K</b>	Cast iron	—
<b>N</b>	Aluminum	—
<b>S</b>	Ni / Ti alloys	●
<b>H</b>	Hardened steel	—

●=Optimal ○=Secondary

Speed and Feed data found on page 288

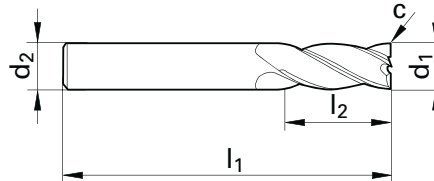

d1 h10	d2 h6	l1	l2	c	No. of Flutes	Code no.	EDP Number
inch	inch	inch	inch	inch x 45°			
3/16	3/16	2 1/2	3/4	0.002	4	4.760	<b>9067740047600</b>
1/4	1/4	3	1	0.002	4	6.350	<b>9067740063500</b>
5/16	5/16	3	1 1/4	0.004	4	7.940	<b>9067740079400</b>
3/8	3/8	3 1/2	1 1/2	0.005	4	9.520	<b>9067740095200</b>
1/2	1/2	4 1/2	2	0.006	4	12.700	<b>9067740127000</b>
5/8	5/8	5	2 1/4	0.007	4	15.870	<b>9067740158700</b>
3/4	3/4	5	2 1/2	0.009	4	19.050	<b>9067740190500</b>

# RF 100 Speed (4-flute) - Metric - XL Long Length



center cutting - with chip breaker

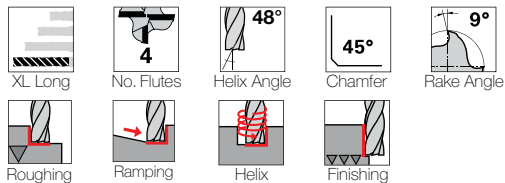

Tool material

Solid Carbide

Surface finish

Super-A™

Series

6766

6761

Application group	Material examples	Ideal for
P	Steel	●
M	Stainless steel	●
K	Cast iron	—
N	Aluminum	—
S	Ni / Ti alloys	●
H	Hardened steel	—

●=Optimal ○=Secondary

Speed and Feed data found on page 300

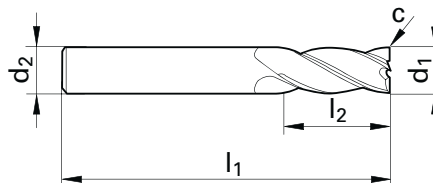

d1 h10	d2 h6	l1	l2	c	No. of Flutes	Code no.	EDP Number	
mm	mm	mm	mm	mm x 45°				
3.000	6.000	57.00	12.00	0.045	4	3.000	9067660030000	9067610030000
4.000	6.000	65.00	16.00	0.060	4	4.000	9067660040000	9067610040000
5.000	6.000	65.00	20.00	0.075	4	5.000	9067660050000	9067610050000
6.000	6.000	65.00	24.00	0.090	4	6.000	9067660060000	9067610060000
8.000	8.000	75.00	32.00	0.120	4	8.000	9067660080000	9067610080000
10.000	10.000	90.00	40.00	0.150	4	10.000	9067660100000	9067610100000
12.000	12.000	100.00	46.00	0.180	4	12.000	9067660120000	9067610120000
16.000	16.000	108.00	55.00	0.240	4	16.000	9067660160000	9067610160000
20.000	20.000	126.00	65.00	0.300	4	20.000	9067660200000	9067610200000

Recommended holders for Guhring end mills:

# HPC PRECISION CLAMPING CHUCKS

Guhring's precision clamping chucks offer extremely high clamping forces while maintaining extremely tight concentricity tolerances, making it an ideal solution for milling operations, as well as drilling and reaming applications. It excels in both heavy-duty and high-speed machining applications. The special clamping sleeve is clamped via a worm gear, which transfers the optimal clamping force onto the tool shank. This creates clamping forces of > 200 Nm for 12 mm shank diameters and > 300 Nm for 16 mm shank diameters.

**Now available with  
PinLock Pull-out  
Protection!**

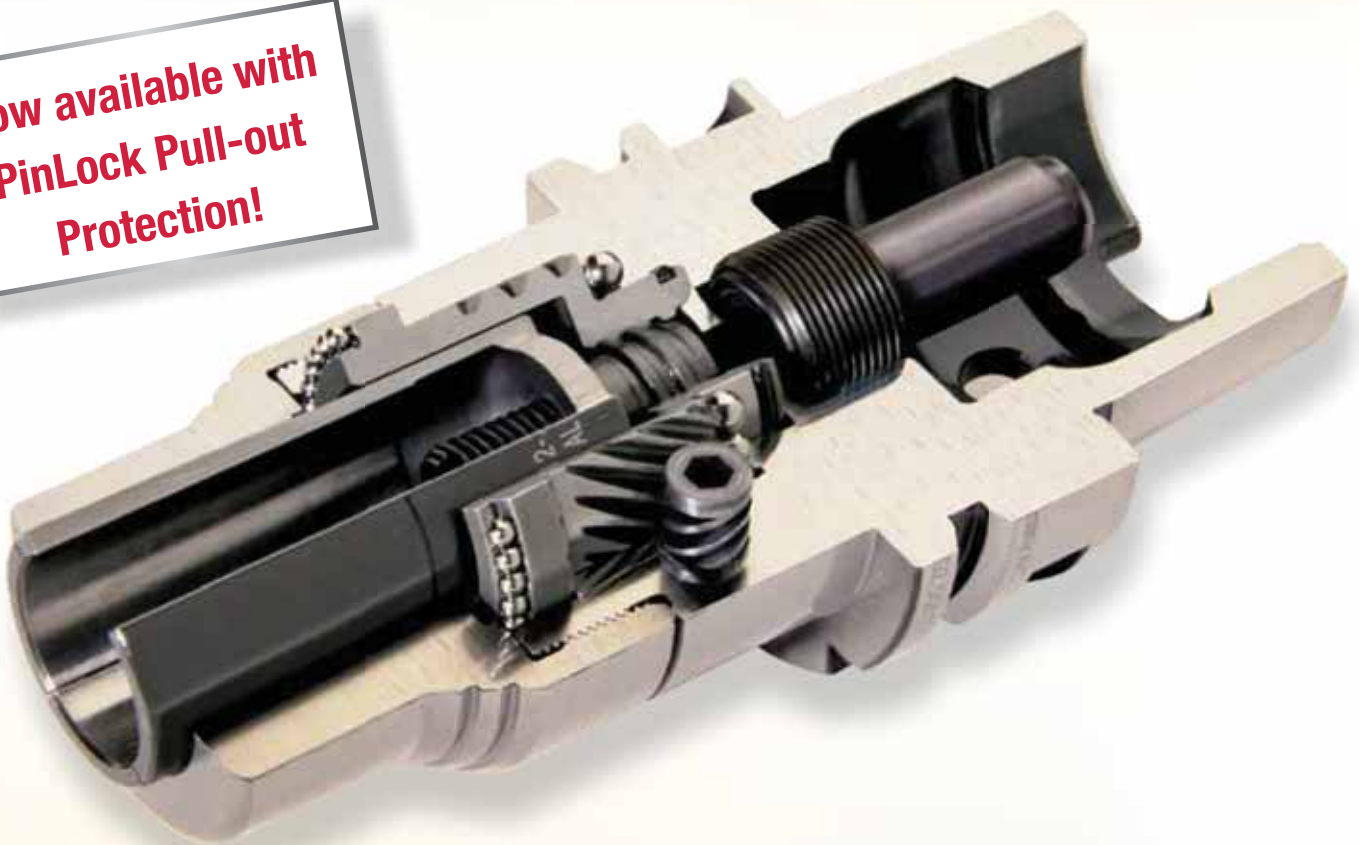

## **This system offers the following advantages:**

- Increased cutting depths in comparison to conventional tool holders
- Increased radial engagement and subsequently higher material removal rate
- Maintenance-free technology
- Suitable for use with both round shanks and flatted shanks
- Concentricity 3  $\mu\text{m}$  with 2,5 x D
- Balancing quality: G2.5 / 20.000 rev./min or  $U < 1.2\text{gmm}$

# RF 100 90°

sharp corner milling cutter  
without corner chamfers  
for semi-finishing and fine-finishing

**P M K N S H**

the suitable solution for multiple materials: Steel, cast iron, stainless materials, titanium- and special alloys and aluminium

Stable face geometry thanks to lip correction at cutting edge

### Sharp corner – no corner chamfer

For components in electronics, medical, aviation, and machine builders where precise 90° corners are required.

**90°**

Variable helix & flute spacing for chatter free operation

RF 100 SF · Guhring series 6776

RF 100 A · Guhring series 6775

RF 100 F · Guhring series 6764

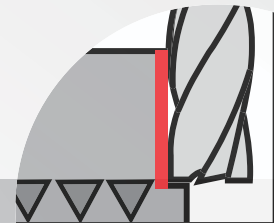

Optimal surface finish when side and face milling on wall and base geometries

Perfect for HPC / HSC strategies such as Trochoidal milling or

**i**machining®

# RF 100 A 90° (3-flute) - Inch - Standard Length



## center cutting



Standard



No. Flutes



Helix Angle



Rake Angle



Slotting



Roughing



Ramping



Helix



Plunging



Finishing



HA



HB

Tool material

**Solid Carbide**

Surface finish

bright

Series

**6775**

Application group	Material examples	Ideal for
<b>P</b>	Steel	—
<b>M</b>	Stainless steel	—
<b>K</b>	Cast iron	—
<b>N</b>	Aluminum	●
<b>S</b>	Titanium alloys	—
<b>H</b>	Hardened steel	—

●=Optimal ○=Secondary

Speed and Feed data found on page 290

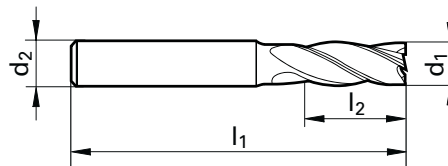

d1 h10	d2 h6	l1	l2	No. of Flutes	Code no.	EDP Number
inch	inch	inch	inch			
1/8	1/8	2	1/2	3	3.170	9067750031700
3/16	3/16	2	5/8	3	4.760	9067750047600
1/4	1/4	2 1/2	3/4	3	6.350	9067750063500
5/16	5/16	2 1/2	13/16	3	7.940	9067750079400
3/8	3/8	2 1/2	1	3	9.520	9067750095200
1/2	1/2	3 1/2	1 1/4	3	12.700	9067750127000
5/8	5/8	3 1/2	1 1/4	3	15.870	9067750158700
3/4	3/4	4	1 1/2	3	19.050	9067750190500

# RF 100 A 90° (4-flute) - Metric - Standard Length



## center cutting



Standard



No. Flutes



Helix Angle



Rake Angle



Roughing



Finishing



Tool material

**Solid Carbide**

Surface finish

bright

Series

**6762**

Application group	Material examples	Ideal for
<b>P</b>	Steel	—
<b>M</b>	Stainless steel	—
<b>K</b>	Cast iron	—
<b>N</b>	Aluminum	●
<b>S</b>	Ni / Ti alloys	—
<b>H</b>	Hardened steel	—

●=Optimal ○=Secondary

Speed and Feed data found on page 302

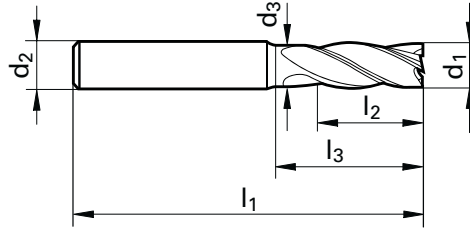

d1 h10	d2 h6	d3	l1	l2	l3	No. of Flutes	Code no.	EDP Number
mm	mm	mm	mm	mm	mm			
3.00	6.00	2.80	57	8	15	4	3.000	9067620030000
4.00	6.00	3.80	57	11	18	4	4.000	9067620040000
5.00	6.00	4.80	57	13	18	4	5.000	9067620050000
6.00	6.00	5.70	57	13	20	4	6.000	9067620060000
8.00	8.00	7.70	63	19	26	4	8.000	9067620080000
10.00	10.00	9.50	72	22	30	4	10.000	9067620100000
12.00	12.00	11.50	83	26	36	4	12.000	9067620120000
16.00	16.00	15.50	92	32	42	4	16.000	9067620160000
20.00	20.00	19.50	104	38	52	4	20.000	9067620200000



# RF 100 SF 90° (5-flute) - Inch - Standard Length

a

## center cutting



Standard



No. Flutes



Helix Angle



Rake Angle



Finishing



HA



HB

Tool material

Solid Carbide

Surface finish

nano-A™

Series

6776

Application group	Material examples	Ideal for
P	Steel	●
M	Stainless steel	●
K	Cast iron	●
N	Aluminum	—
S	Ni / Ti alloys	●
H	Hardened steel	—

●=Optimal ○=Secondary

Speed and Feed data found on page 290

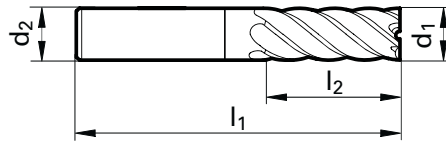

d1 h10	d2 h6	l1	l2	No. of Flutes	Code no.	EDP Number
mm	mm	mm	mm			
3/16	3/16	2	5/8	5	4.760	9067760047600
1/4	1/4	2 1/2	3/4	5	6.350	9067760063500
5/16	5/16	2 1/2	13/16	5	7.940	9067760079400
3/8	3/8	2 1/2	1	5	9.520	9067760095200
1/2	1/2	3 1/2	1 1/4	5	12.700	9067760127000
5/8	5/8	3 1/2	1 1/4	5	15.870	9067760158700
3/4	3/4	4	1 1/2	5	19.050	9067760190500

# RF 100 SF 90° (5-flute) - Metric - XL Long Length



## center cutting



XL Long



No. Flutes



Helix Angle



Rake Angle



Finishing



HA

Tool material

Solid Carbide

Surface finish

nano-A™

Series

6763

Application group	Material examples	Ideal for
P	Steel	●
M	Stainless steel	●
K	Cast iron	●
N	Aluminum	—
S	Ni / Ti alloys	●
H	Hardened steel	—

●=Optimal ○=Secondary

Speed and Feed data found on page 302

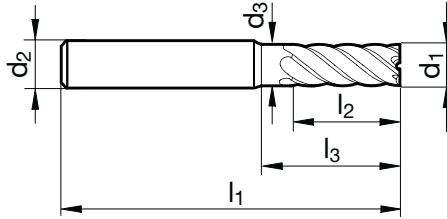

d1 h10	d2 h6	d3	l1	l2	l3	No. of Flutes	Code no.	EDP Number
mm	mm	mm	mm	mm	mm			
4.000	6.00	3.80	65	12	26	5	4.000	9067630040000
5.000	6.00	4.80	65	15	26	5	5.000	9067630050000
6.000	6.00	5.70	65	18	28	5	6.000	9067630060000
8.000	8.00	7.70	75	24	32	5	8.000	9067630080000
10.000	10.00	9.50	80	30	32	5	10.000	9067630100000
12.000	12.00	11.50	93	36	46	5	12.000	9067630120000
16.000	16.00	15.50	108	48	58	5	16.000	9067630160000
20.000	20.00	19.50	126	60	74	5	20.000	9067630200000

# RF 100 F 90° (4-flute) - Metric - Standard Length

a

## center cutting



Standard



No. Flutes



Helix Angle



Rake Angle



Slotting



Roughing



Ramping



Helix



Finishing



Tool material

**Solid Carbide**

Surface finish

nano-A™

Series

**6764**

Application group	Material examples	Ideal for
P	Steel	●
M	Stainless steel	●
K	Cast iron	○
N	Aluminum	—
S	Ni / Ti alloys	●
H	Hardened steel	—

●=Optimal    ○=Secondary

Speed and Feed data found on page 302

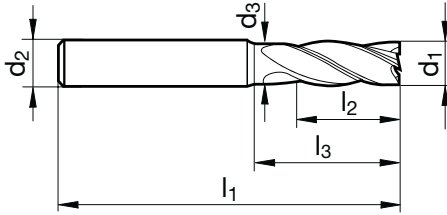

d1 h10	d2 h6	d3	l1	l2	l3	No. of Flutes	Code no.	EDP Number
mm	mm	mm	mm	mm	mm			
3.00	6.00	2.80	57	8	15	4	3.000	9067640030000
4.00	6.00	3.80	57	11	18	4	4.000	9067640040000
5.00	6.00	4.80	57	13	18	4	5.000	9067640050000
6.00	6.00	5.70	57	13	20	4	6.000	9067640060000
8.00	8.00	7.70	63	19	26	4	8.000	9067640080000
10.00	10.00	9.50	72	22	30	4	10.000	9067640100000
12.00	12.00	11.50	83	26	36	4	12.000	9067640120000
16.00	16.00	15.50	92	32	42	4	16.000	9067640160000
20.00	20.00	19.50	104	38	52	4	20.000	9067640200000

# RF 100 U

High-performance end mills for materials up to 1600 N/mm<sup>2</sup> (48 HRC)



RF 100 U · Guhring series 3114

**P M K N S H**

The suitable solution for multiple materials: Steel, cast iron, stainless materials, titanium- and special alloys and aluminum

For extremely high feed rates thanks to especially light cutting operation. Low power consumption allows application on weaker machines. Large selection of lengths, intermediate and undersized dimensions. New end geometry with three faceted center cutting edges for asymmetrical load and symmetrical chips and large chip spaces for outstanding chip evacuation.



Face cutting geometry with reinforced cutting edges and larger chip spaces for drilling and ramping operations.



Micro-corner protection for longer tool life

# RF 100 U (4-flute) - Inch - Stub Length



## center cutting

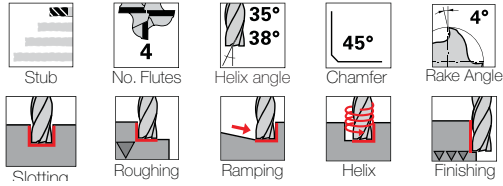

Tool material

**Solid Carbide**

Surface finish

FIREX®

Series

3113

3099

Application group	Material examples	Ideal for
P	Steel	●
M	Stainless steel	○
K	Cast iron	●
N	Aluminum	—
S	Ni / Ti alloys	○
H	Hardened steel	○

●=Optimal    ○=Secondary

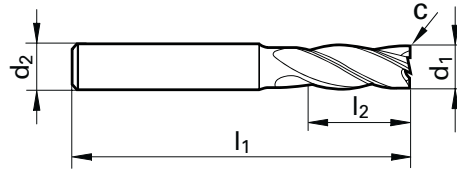

Speed and Feed data found on page 290

d1 h10	d2 h6	l1	l2	c	No. of Flutes	Code no.	EDP Number
inch	inch	inch	inch	inch x 45°			
3/16	3/16	2	3/8	0.004	4	4.760	9031130047600
1/4	1/4	2	1/2	0.006	4	6.350	9031130063500
5/16	5/16	2	1/2	0.006	4	7.940	9031130079400
3/8	3/8	2	5/8	0.008	4	9.520	9031130095200 9030990095200
1/2	1/2	2 1/2	5/8	0.010	4	12.700	9031130127000 9030990127000
5/8	5/8	3	3/4	0.014	4	15.870	9031130158700 9030990158700
3/4	3/4	3	1	0.018	4	19.050	9031130190500 9030990190500
1	1	3	1	0.031	4	25.400	9031130254000

# RF 100 U (4-flute) - Metric - Stub Length



## center cutting

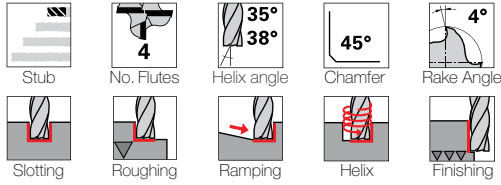

Tool material

Solid Carbide

Surface finish

FIREX®

Series

6706

3731

Application group	Material examples	Ideal for
P	Steel	●
M	Stainless steel	○
K	Cast iron	●
N	Aluminum	—
S	Ni / Ti alloys	○
H	Hardened steel	○

●=Optimal    ○=Secondary

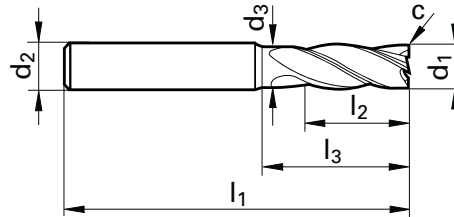

Speed and Feed data found on page 302

d1 h10	d2 h6	d3	l1	l2	l3	c	No. of Flutes	Code no.	EDP Number	
mm	mm	mm	mm	mm	mm	mm x 45°				
3.000	6.000	2.800	50.00	5.00	12.00	0.10	4	3.000	9067060030000	9037310030000
4.000	6.000	3.800	54.00	8.00	15.00	0.10	4	4.000	9067060040000	9037310040000
5.000	6.000	4.800	54.00	9.00	15.00	0.10	4	5.000	9067060050000	9037310050000
6.000	6.000	5.700	54.00	10.00	17.00	0.15	4	6.000	9067060060000	9037310060000
8.000	8.000	7.700	58.00	12.00	21.00	0.15	4	8.000	9067060080000	9037310080000
10.000	10.000	9.500	66.00	14.00	24.00	0.20	4	10.000	9067060100000	9037310100000
12.000	12.000	11.500	73.00	16.00	26.00	0.20	4	12.000	9067060120000	9037310120000
14.000	14.000	13.500	75.00	18.00	28.00	0.25	4	14.000	9067060140000	9037310140000
16.000	16.000	15.500	82.00	22.00	32.00	0.35	4	16.000	9067060160000	9037310160000
18.000	18.000	17.500	84.00	24.00	34.00	0.40	4	18.000	9067060180000	9037310180000
20.000	20.000	19.500	92.00	26.00	40.00	0.45	4	20.000	9067060200000	9037310200000

# RF 100 U (4-flute) - Inch - Standard Length



## center cutting

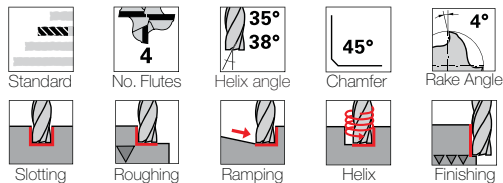

Tool material

**Solid Carbide**

Surface finish

**FIREX®**

Series

**3114**

**3100**

Application group	Material examples	Ideal for
<b>P</b>	Steel	●
<b>M</b>	Stainless steel	○
<b>K</b>	Cast iron	●
<b>N</b>	Aluminum	—
<b>S</b>	Ni / Ti alloys	○
<b>H</b>	Hardened steel	○

●=Optimal    ○=Secondary

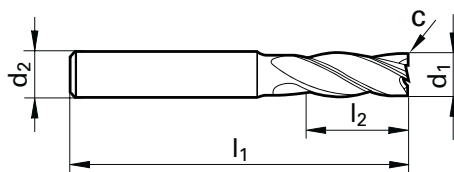

Speed and Feed data found on page 290

d1 h10	d2 h6	l1	l2	c	No. of Flutes	Code no.	EDP Number
inch	inch	inch	inch	inch x 45°			
1/8	1/8	2	3/8	0.002	4	3.170	9031140031700
3/16	3/16	2	5/8	0.004	4	4.760	9031140047600
1/4	1/4	2 1/2	3/4	0.006	4	6.350	9031140063500
5/16	5/16	2 1/2	13/16	0.006	4	7.940	9031140079400
3/8	3/8	2 1/2	1	0.008	4	9.520	9031140095200 9031000095200
7/16	7/16	2 3/4	1	0.008	4	11.110	9031140111100
1/2	1/2	3	1	0.010	4	12.700	9031140127000 9031000127000
5/8	5/8	3 1/2	1 1/4	0.014	4	15.870	9031140158700 9031000158700
3/4	3/4	4	1 1/2	0.018	4	19.050	9031140190500 9031000190500
1	1	4	1 1/2	0.031	4	25.400	9031140254000 9031000254000
1 1/4	1 1/4	6	2 1/2	0.031	4	31.750	9031140317500

# RF 100 U (4-flute) - Inch - Standard Length



## center cutting - with corner radius options

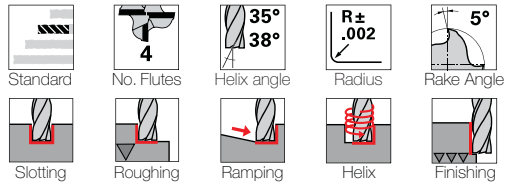

Tool material

**Solid Carbide**

Surface finish

FIREX®

Series

**3079**

Application group	Material examples	Ideal for
<b>P</b>	Steel	●
<b>M</b>	Stainless steel	○
<b>K</b>	Cast iron	●
<b>N</b>	Aluminum	—
<b>S</b>	Ni / Ti alloys	○
<b>H</b>	Hardened steel	○

●=Optimal    ○=Secondary

Speed and Feed data found on page 290

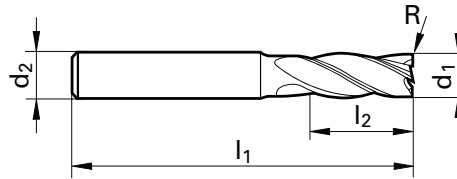

d1 h10	d2 h6	l1	l2	R	No. of Flutes	Code no.	EDP Number
inch	inch	inch	inch	inch			
1/4	1/4	2 1/2	3/4	0.015	4	6.352	9030790063520
1/4	1/4	2 1/2	3/4	0.031	4	6.354	9030790063540
5/16	5/16	2 1/2	13/16	0.031	4	7.944	9030790079440
3/8	3/8	2 1/2	1	0.031	4	9.524	9030790095240
7/16	7/16	2 3/4	1	0.031	4	11.114	9030790111140
1/2	1/2	3 1/2	1 1/4	0.031	4	12.704	9030790127040
1/2	1/2	3 1/2	1 1/4	0.040	4	12.705	9030790127050
1/2	1/2	3 1/2	1 1/4	0.062	4	12.706	9030790127060
1/2	1/2	3 1/2	1 1/4	0.090	4	12.707	9030790127070
5/8	5/8	3 1/2	1 1/4	0.031	4	15.874	9030790158740
5/8	5/8	3 1/2	1 1/4	0.062	4	15.876	9030790158760
3/4	3/4	4	1 1/2	0.062	4	19.056	9030790190560
3/4	3/4	4	1 1/2	0.090	4	19.057	9030790190570
3/4	3/4	4	1 1/2	0.125	4	19.059	9030790190590
1	1	4	1 1/2	0.062	4	25.406	9030790254060
1	1	4	1 1/2	0.090	4	25.407	9030790254070
1	1	4	1 1/2	0.125	4	25.409	9030790254090



# RF 100 U (4-flute) - Metric - Standard Length



## center cutting

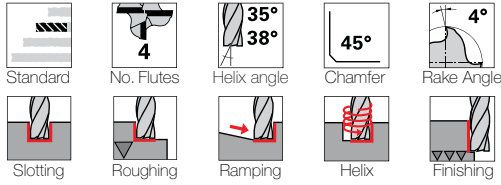

Tool material

**Solid Carbide**

Surface finish

**FIREX®**

Series

**3736**

**3732**

Application group	Material examples	Ideal for
P	Steel	●
M	Stainless steel	○
K	Cast iron	●
N	Aluminum	—
S	Ni / Ti alloys	○
H	Hardened steel	○

●=Optimal    ○=Secondary

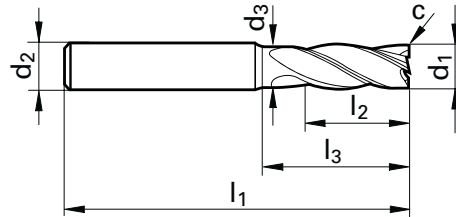

Speed and Feed data found on page 302

d1 e8	d2 h6	d3	l1	l2	l3	c	No. of Flutes	Code no.	EDP Number	
mm	mm	mm	mm	mm	mm	mm x 45°				
3.000	6.000	2.800	57.00	8.00	15.00	0.10	4	3.000	9037360030000	9037320030000
4.000	6.000	3.800	57.00	11.00	18.00	0.10	4	4.000	9037360040000	9037320040000
5.000	6.000	4.800	57.00	13.00	18.00	0.10	4	5.000	9037360050000	9037320050000
6.000	6.000	5.700	57.00	13.00	20.00	0.15	4	6.000	9037360060000	9037320060000
8.000	8.000	7.700	63.00	19.00	26.00	0.15	4	8.000	9037360080000	9037320080000
10.000	10.000	9.500	72.00	22.00	30.00	0.20	4	10.000	9037360100000	9037320100000
12.000	12.000	11.500	83.00	26.00	36.00	0.20	4	12.000	9037360120000	9037320120000
14.000	14.000	13.500	83.00	26.00	36.00	0.25	4	14.000	9037360140000	9037320140000
16.000	16.000	15.500	92.00	32.00	42.00	0.35	4	16.000	9037360160000	9037320160000
18.000	18.000	17.500	92.00	32.00	42.00	0.40	4	18.000	9037360180000	9037320180000
20.000	20.000	19.500	104.00	38.00	52.00	0.45	4	20.000	9037360200000	9037320200000
25.000	25.000	24.000	121.00	45.00	63.00	0.60	4	25.000	9037360250000	9037320250000

# RF 100 U (4-flute) - Metric - Standard Length



center cutting - with corner radius options

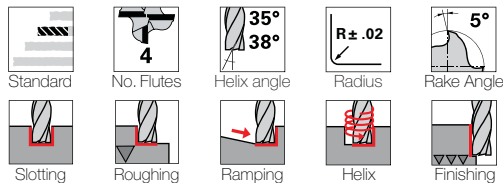

Tool material

Solid Carbide

Surface finish

FIREX®

Series

3872

3873

Application group	Material examples	Ideal for
P	Steel	●
M	Stainless steel	○
K	Cast iron	●
N	Aluminum	—
S	Ni / Ti alloys	○
H	Hardened steel	○

●=Optimal    ○=Secondary

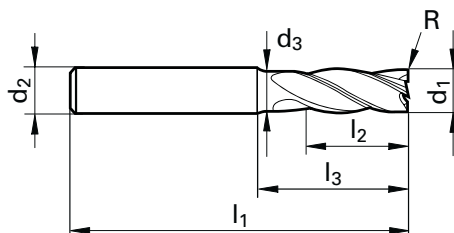

Speed and Feed data found on page 302

d1 h10	d2 h6	d3	l1	l2	l3	r	No. of Flutes	Code no.	EDP Number	
mm	mm	mm	mm	mm	mm	mm				
6.000	6.000	5.700	57.00	13.00	20.00	0.50	4	6.005	9038720060050	9038730060050
6.000	6.000	5.700	57.00	13.00	20.00	1.00	4	6.010	9038720060100	9038730060100
6.000	6.000	5.700	57.00	13.00	20.00	2.00	4	6.020	9038720060200	9038730060200
8.000	8.000	7.700	63.00	19.00	26.00	0.50	4	8.005	9038720080050	9038730080050
8.000	8.000	7.700	63.00	19.00	26.00	1.00	4	8.010	9038720080100	9038730080100
8.000	8.000	7.700	63.00	19.00	26.00	2.00	4	8.020	9038720080200	9038730080200
10.000	10.000	9.500	72.00	22.00	30.00	0.50	4	10.005	9038720100050	9038730100050
10.000	10.000	9.500	72.00	22.00	30.00	1.00	4	10.010	9038720100100	9038730100100
10.000	10.000	9.500	72.00	22.00	30.00	2.00	4	10.020	9038720100200	9038730100200
12.000	12.000	11.500	83.00	26.00	36.00	0.50	4	12.005	9038720120050	9038730120050
12.000	12.000	11.500	83.00	26.00	36.00	1.00	4	12.010	9038720120100	9038730120100
12.000	12.000	11.500	83.00	26.00	36.00	2.00	4	12.020	9038720120200	9038730120200
16.000	16.000	15.500	92.00	32.00	42.00	0.50	4	16.005	9038720160050	9038730160050
16.000	16.000	15.500	92.00	32.00	42.00	1.00	4	16.010	9038720160100	9038730160100
16.000	16.000	15.500	92.00	32.00	42.00	2.00	4	16.020	9038720160200	9038730160200
16.000	16.000	15.500	92.00	32.00	42.00	3.00	4	16.030	9038720160300	9038730160300
20.000	20.000	19.500	104.00	38.00	52.00	0.50	4	20.005	9038720200050	9038730200050
20.000	20.000	19.500	104.00	38.00	52.00	1.00	4	20.010	9038720200100	9038730200100
20.000	20.000	19.500	104.00	38.00	52.00	2.00	4	20.020	9038720200200	9038730200200
20.000	20.000	19.500	104.00	38.00	52.00	3.00	4	20.030	9038720200300	9038730200300
25.000	25.000	24.000	121.00	45.00	63.00	2.00	4	25.020	9038720250200	9038730250200
25.000	25.000	24.000	121.00	45.00	63.00	3.00	4	25.030	9038720250300	9038730250300

# RF 100 U (4-flute) - Inch - Long Length



## center cutting



Long



No. Flutes



Helix angle



Chamfer



Rake Angle



Slotting



Roughing



Ramping



Helix



Finishing



HA



HB

Tool material

**Solid Carbide**

Surface finish

FIREX®

Series

**4250**

Application group	Material examples	Ideal for
<b>P</b>	Steel	●
<b>M</b>	Stainless steel	○
<b>K</b>	Cast iron	●
<b>N</b>	Aluminum	—
<b>S</b>	Ni / Ti alloys	○
<b>H</b>	Hardened steel	○

●=Optimal    ○=Secondary

Speed and Feed data found on page 290

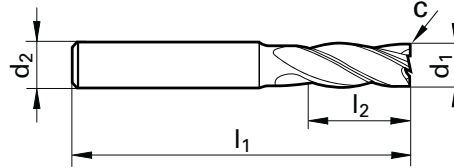

d1 h10	d2 h6	l1	l2	c	No. of Flutes	Code no.	EDP Number
inch	inch	inch	inch	inch x 45°			
3/16	3/16	2 1/2	3/4	0.004	4	4.760	<b>9042500047600</b>
1/4	1/4	3 1/4	1 1/4	0.006	4	6.350	<b>9042500063500</b>
5/16	5/16	3 1/4	1 1/2	0.006	4	7.940	<b>9042500079400</b>
3/8	3/8	4	1 3/4	0.008	4	9.520	<b>9042500095200</b>
7/16	7/16	4 1/2	2	0.008	4	11.110	<b>9042500111100</b>
1/2	1/2	4 1/2	2	0.010	4	12.700	<b>9042500127000</b>
5/8	5/8	5	2 1/4	0.014	4	15.870	<b>9042500158700</b>
3/4	3/4	5	2 1/4	0.018	4	19.050	<b>9042500190500</b>
1	1	5	2 1/4	0.031	4	25.400	<b>9042500254000</b>

# RF 100 U (4-flute) - Inch - Long Length



## center cutting

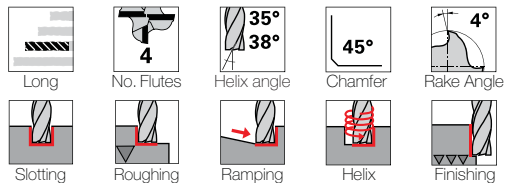

Tool material

**Solid Carbide**

Surface finish

**FIREX®**

Series

**4251**

Application group	Material examples	Ideal for
<b>P</b>	Steel	●
<b>M</b>	Stainless steel	○
<b>K</b>	Cast iron	●
<b>N</b>	Aluminum	—
<b>S</b>	Ni / Ti alloys	○
<b>H</b>	Hardened steel	○

●=Optimal    ○=Secondary

Speed and Feed data found on page 290

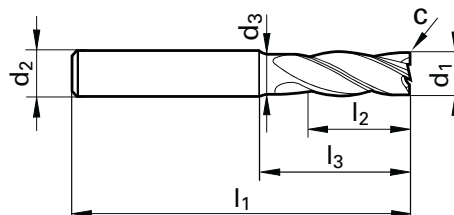

d1 h10	d2 h6	d3	l1	l2	l3	c	No. of Flutes	Code no.	EDP Number
mm	mm	mm	mm	mm	mm	mm x 45°			
3/16	3/16	0.176	2 1/2	5/8	1	0.004	4	4.760	<b>9042510047600</b>
1/4	1/4	0.230	3 1/4	3/4	1 3/4	0.006	4	6.350	<b>9042510063500</b>
5/16	5/16	0.293	3 1/4	13/16	1 3/4	0.006	4	7.940	<b>9042510079400</b>
3/8	3/8	0.355	4	1	2 1/4	0.008	4	9.520	<b>9042510095200</b>
7/16	7/16	0.406	4 1/2	1	2 1/2	0.008	4	11.110	<b>9042510111100</b>
1/2	1/2	0.469	4 1/2	1 1/4	2 1/2	0.010	4	12.700	<b>9042510127000</b>
5/8	5/8	0.594	5	1 1/4	2 1/2	0.014	4	15.870	<b>9042510158700</b>
3/4	3/4	0.711	5	1 1/2	2 1/2	0.018	4	19.050	<b>9042510190500</b>
1	1	0.941	5	1 1/2	2 5/8	0.031	4	25.400	<b>9042510254000</b>

# RF 100 U (4-flute) - Metric - Long Length



## center cutting



Long



No. Flutes



Helix angle



Chamfer



Rake Angle



Slotting



Roughing



Ramping



Helix



Finishing



HA



HB

Tool material

Solid Carbide

Surface finish

FIREX®

Series

3837

3838

Application group	Material examples	Ideal for
P	Steel	●
M	Stainless steel	○
K	Cast iron	●
N	Aluminum	—
S	Ni / Ti alloys	○
H	Hardened steel	○

●=Optimal    ○=Secondary

Speed and Feed data found on page 302

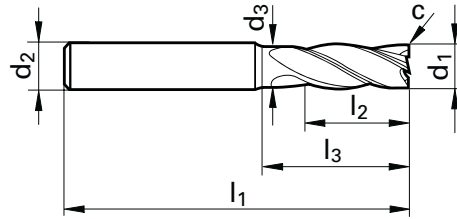

d1 e8	d2 h6	d3	l1	l2	l3	c	No. of Flutes	Code no.	EDP Number	
mm	mm	mm	mm	mm	mm	mm x 45°				
6.000	6.000	5.700	65.00	13.00	28.00	0.15	4	6.000	9038370060000	9038380060000
8.000	8.000	7.700	75.00	19.00	38.00	0.15	4	8.000	9038370080000	9038380080000
10.000	10.000	9.500	80.00	22.00	38.00	0.20	4	10.000	9038370100000	9038380100000
12.000	12.000	11.500	93.00	26.00	46.00	0.20	4	12.000	9038370120000	9038380120000
16.000	16.000	15.500	108.00	32.00	58.00	0.35	4	16.000	9038370160000	9038380160000
20.000	20.000	19.500	126.00	38.00	74.00	0.45	4	20.000	9038370200000	9038380200000

# RF 100 U (4-flute) - Inch - Long Length



## center cutting

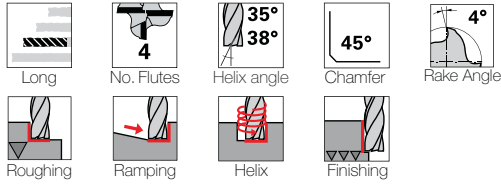

Tool material

**Solid Carbide**

Surface finish

FIREX®

Series

**4252**

Application group	Material examples	Ideal for
<b>P</b>	Steel	●
<b>M</b>	Stainless steel	○
<b>K</b>	Cast iron	●
<b>N</b>	Aluminum	—
<b>S</b>	Ni / Ti alloys	○
<b>H</b>	Hardened steel	○

●=Optimal    ○=Secondary

Speed and Feed data found on page 290

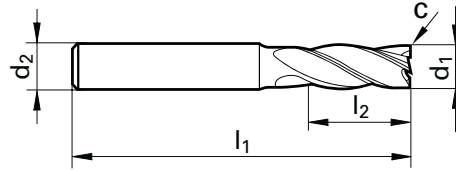

d1 h10	d2 h6	l1	l2	c	No. of Flutes	Code no.	EDP Number
inch	inch	inch	inch	inch x 45°			
1/4	1/4	4	1 3/4	0.006	4	6.350	<b>9042520063500</b>
5/16	5/16	4	1 3/4	0.006	4	7.940	<b>9042520079400</b>
3/8	3/8	4	2 1/4	0.008	4	9.520	<b>9042520095200</b>
7/16	7/16	5	3	0.008	4	11.110	<b>9042520111100</b>
1/2	1/2	5	3	0.010	4	12.700	9042520127000
5/8	5/8	6	3	0.014	4	15.870	9042520158700
3/4	3/4	6	3 1/8	0.018	4	19.050	9042520190500
1	1	6	3 1/8	0.031	4	25.400	9042520254000
1 1/4	1 1/4	7 1/2	4	0.031	4	31.750	9042520317500

# RF 100 U (4-flute) - Metric - XL Long Length (3xD)



## center cutting

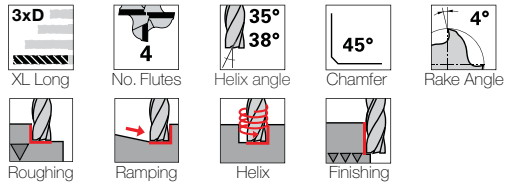

Tool material

**Solid Carbide**

Surface finish

**FIREX®**

Series

**3839**

**3871**

Application group	Material examples	Ideal for
P	Steel	●
M	Stainless steel	○
K	Cast iron	●
N	Aluminum	—
S	Ni / Ti alloys	○
H	Hardened steel	○

●=Optimal    ○=Secondary

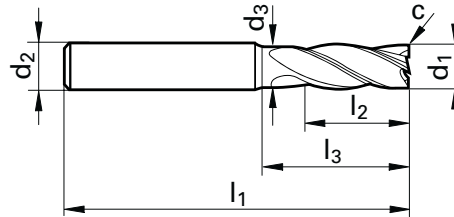

Speed and Feed data found on page 302

d1 h10	d2 h6	d3	l1	l2	l3	c	No. of Flutes	Code no.	EDP Number	
mm	mm	mm	mm	mm	mm	mm x 45°				
6.000	6.000	5.700	65.00	18.00	28.00	0.15	4	6.000	9038390060000	9038710060000
8.000	8.000	7.700	75.00	24.00	38.00	0.15	4	8.000	9038390080000	9038710080000
10.000	10.000	9.500	80.00	30.00	38.00	0.20	4	10.000	9038390100000	9038710100000
12.000	12.000	11.500	93.00	36.00	46.00	0.20	4	12.000	9038390120000	9038710120000
16.000	16.000	15.500	108.00	48.00	58.00	0.35	4	16.000	9038390160000	9038710160000
20.000	20.000	19.500	126.00	60.00	74.00	0.45	4	20.000	9038390200000	9038710200000

# RF 100 U (4-flute) - Inch - XL Long Length



## center cutting



XL Long



No. Flutes



Helix angle



Chamfer



Rake Angle



Roughing



Ramping



Helix



Finishing



HB

Tool material

**Solid Carbide**

Surface finish

FIREX®

Series

**4253**

Application group	Material examples	Ideal for
<b>P</b>	Steel	●
<b>M</b>	Stainless steel	○
<b>K</b>	Cast iron	●
<b>N</b>	Aluminum	—
<b>S</b>	Ni / Ti alloys	○
<b>H</b>	Hardened steel	○

●=Optimal    ○=Secondary

Speed and Feed data found on page 290

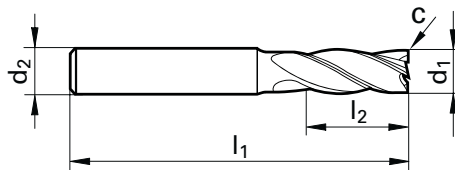

d1 h10	d2 h6	l1	l2	c	No. of Flutes	Code no.	EDP Number
inch	inch	inch	inch	inch x 45°			
1/2	1/2	6	3 1/2	0.010	4	12.700	9042530127000
5/8	5/8	6	3 3/4	0.014	4	15.870	9042530158700
3/4	3/4	6 1/2	4	0.018	4	19.050	9042530190500
1	1	7	4	0.031	4	25.400	9042530254000



# RF 100 U (4-flute) - Metric - XL Long Length (4xD)



## center cutting

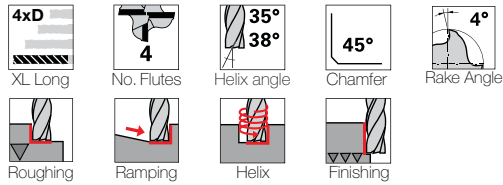

Tool material

**Solid Carbide**

Surface finish

FIREX®

Series

**3627**

Application group	Material examples	Ideal for
P	Steel	●
M	Stainless steel	○
K	Cast iron	●
N	Aluminum	—
S	Ni / Ti alloys	○
H	Hardened steel	○

●=Optimal   ○=Secondary

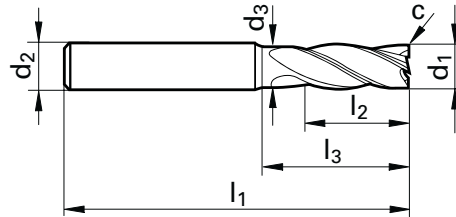

Speed and Feed data found on page 302

d1 h10	d2 h6	d3	l1	l2	l3	c	No. of Flutes	Code no.	EDP Number
mm	mm	mm	mm	mm	mm	mm x 45°			
10.000	10.000	9.500	100.00	40.00	48.00	0.20	4	10.000	9036270100000
12.000	12.000	11.500	150.00	45.00	58.00	0.20	4	12.000	9036270120000
14.000	14.000	13.500	150.00	45.00	58.00	0.25	4	14.000	9036270140000
16.000	16.000	15.500	150.00	65.00	78.00	0.35	4	16.000	9036270160000
18.000	18.000	17.500	150.00	65.00	78.00	0.40	4	18.000	9036270180000
20.000	20.000	19.500	150.00	65.00	78.00	0.45	4	20.000	9036270200000
25.000	25.000	24.000	150.00	75.00	92.00	0.60	4	25.000	9036270250000

# RF 100 U (3-flute) - Inch - Standard Length



## center cutting



Standard



No. Flutes



Helix angle



Chamfer



Rake Angle



Slotting



Roughing



Ramping



Helix



Plunging



HA



HB

Tool material

Solid Carbide

Surface finish

FIREX®

Series

4254

Application group	Material examples	Ideal for
P	Steel	●
M	Stainless steel	○
K	Cast iron	●
N	Aluminum	—
S	Ni / Ti alloys	○
H	Hardened steel	○

●=Optimal    ○=Secondary

Speed and Feed data found on page 290

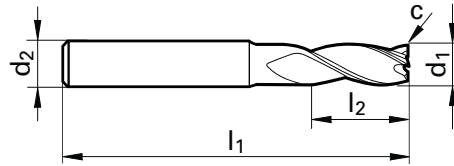

d1 h10	d2 h6	l1	l2	c	No. of Flutes	Code no.	EDP Number
inch	inch	inch	inch	inch x 45°			
1/8	1/8	2	1/2	0.002	3	3.170	9042540031700
3/16	3/16	2	5/8	0.002	3	4.760	9042540047600
1/4	1/4	2 1/2	3/4	0.004	3	6.350	9042540063500
5/16	5/16	2 1/2	13/16	0.004	3	7.940	9042540079400
3/8	3/8	2 1/2	1	0.004	3	9.520	9042540095200
7/16	7/16	2 3/4	1	0.006	3	11.110	9042540111100
1/2	1/2	3 1/2	1 1/4	0.006	3	12.700	9042540127000
5/8	5/8	3 1/2	1 1/4	0.006	3	15.870	9042540158700
3/4	3/4	4	1 1/2	0.006	3	19.050	9042540190500
1	1	4	1 1/2	0.008	3	25.400	9042540254000

# RF 100 U (3-flute) - Inch - Standard Length

F

## center cutting

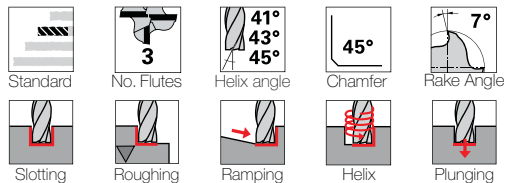

Tool material

Solid Carbide

Surface finish

FIREX®

Series

4255

Application group	Material examples	Ideal for
P	Steel	●
M	Stainless steel	○
K	Cast iron	●
N	Aluminum	—
S	Ni / Ti alloys	○
H	Hardened steel	○

●=Optimal    ○=Secondary

Speed and Feed data found on page 290

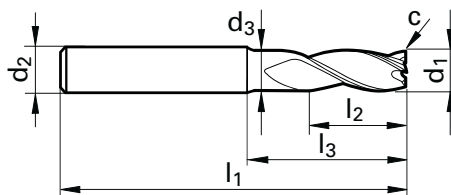

d1 h10	d2 h6	d3	l1	l2	l3	c	No. of Flutes	Code no.	EDP Number
inch	inch	inch	inch	inch	inch	inch x 45°			
1/8	1/8	0.1132	2	1/4	3/4	0.002	3	3.170	9042550031700
3/16	3/16	0.1757	2	3/8	3/4	0.002	3	4.760	9042550047600
1/4	1/4	0.2303	2 1/2	1/2	7/8	0.004	3	6.350	9042550063500
5/16	5/16	0.2928	2 1/2	1/2	7/8	0.004	3	7.940	9042550079400
3/8	3/8	0.3553	2 1/2	5/8	7/8	0.004	3	9.520	9042550095200
1/2	1/2	0.4685	3	5/8	1 1/8	0.006	3	12.700	9042550127000
5/8	5/8	0.5935	3 1/2	3/4	1 1/2	0.006	3	15.870	9042550158700
3/4	3/4	0.7106	4	1	1 3/4	0.006	3	19.050	9042550190500
1	1	0.9409	4	1	1 3/4	0.008	3	25.400	9042550254000

# RF 100 U (3-flute) - Metric - Standard Length



## center cutting

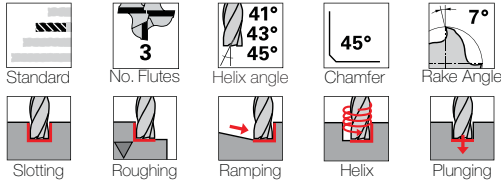

Tool material

Solid Carbide

Surface finish

FIREX®

Series

3893

3894

Application group	Material examples	Ideal for
P	Steel	●
M	Stainless steel	○
K	Cast iron	●
N	Aluminum	—
S	Ni / Ti alloys	○
H	Hardened steel	○

●=Optimal    ○=Secondary

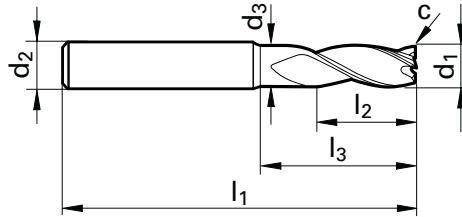

Speed and Feed data found on page 302

d1 e8	d2 h6	d3	l1	l2	l3	c	No. of Flutes	Code no.	EDP Number	
mm	mm	mm	mm	mm	mm	mm x 45°				
3.000	6.000	2.800	57.00	4.00	15.00	0.03	3	3.000	9038930030000	9038940030000
4.000	6.000	3.800	57.00	5.00	18.00	0.06	3	4.000	9038930040000	9038940040000
5.000	6.000	4.800	57.00	6.00	18.00	0.08	3	5.000	9038930050000	9038940050000
6.000	6.000	5.700	57.00	7.00	20.00	0.09	3	6.000	9038930060000	9038940060000
8.000	8.000	7.700	63.00	9.00	26.00	0.12	3	8.000	9038930080000	9038940080000
10.000	10.000	9.500	72.00	11.00	30.00	0.15	3	10.000	9038930100000	9038940100000
12.000	12.000	11.500	83.00	12.00	36.00	0.18	3	12.000	9038930120000	9038940120000
16.000	16.000	15.500	92.00	16.00	42.00	0.19	3	16.000	9038930160000	9038940160000

# RF 100 U (3-flute) - Metric - Standard Length



## center cutting

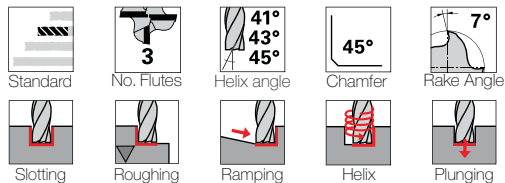

Tool material

Solid Carbide

Surface finish

FIREX®

Series

3891

3892

Application group	Material examples	Ideal for
P	Steel	●
M	Stainless steel	○
K	Cast iron	●
N	Aluminum	—
S	Ni / Ti alloys	○
H	Hardened steel	○

●=Optimal    ○=Secondary

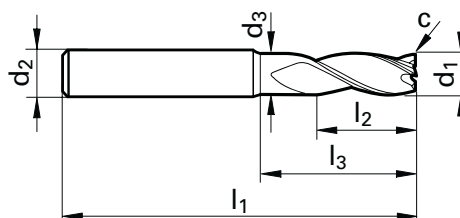

Speed and Feed data found on page 302

d1 e8	d2 h6	d3	l1	l2	l3	c	No. of Flutes	Code no.	EDP Number	
mm	mm	mm	mm	mm	mm	mm x 45°				
3.000	6.000	2.800	57.00	8.00	15.00	0.03	3	3.000	9038910030000	9038920030000
3.500	6.000	3.300	57.00	10.00	15.00	0.05	3	3.500	9038910035000	9038920035000
3.700	6.000	3.500	57.00	11.00	15.00	0.06	3	3.700	9038910037000	9038920037000
4.000	6.000	3.800	57.00	11.00	18.00	0.06	3	4.000	9038910040000	9038920040000
4.500	6.000	4.300	57.00	11.00	18.00	0.07	3	4.500	9038910045000	9038920045000
4.700	6.000	4.500	57.00	13.00	18.00	0.07	3	4.700	9038910047000	9038920047000
5.000	6.000	4.800	57.00	13.00	18.00	0.08	3	5.000	9038910050000	9038920050000
5.500	6.000	5.300	57.00	13.00	19.40	0.08	3	5.500	9038910055000	9038920055000
5.700	6.000	5.500	57.00	13.00	20.40	0.09	3	5.700	9038910057000	9038920057000
6.000	6.000	5.700	57.00	13.00	20.00	0.09	3	6.000	9038910060000	9038920060000
6.500	8.000	6.200	63.00	16.00	24.40	0.10	3	6.500	9038910065000	9038920065000
7.000	8.000	6.700	63.00	16.00	24.90	0.11	3	7.000	9038910070000	9038920070000
7.500	8.000	7.200	63.00	19.00	25.30	0.11	3	7.500	9038910075000	9038920075000
8.000	8.000	7.700	63.00	19.00	26.00	0.12	3	8.000	9038910080000	9038920080000
8.500	10.000	8.200	72.00	19.00	29.40	0.13	3	8.500	9038910085000	9038920085000
9.000	10.000	8.700	72.00	19.00	29.90	0.14	3	9.000	9038910090000	9038920090000
9.500	10.000	9.200	72.00	22.00	30.30	0.14	3	9.500	9038910095000	9038920095000
10.000	10.000	9.500	72.00	22.00	30.00	0.15	3	10.000	9038910100000	9038920100000
12.000	12.000	11.500	83.00	26.00	36.00	0.18	3	12.000	9038910120000	9038920120000
16.000	16.000	15.500	92.00	32.00	42.00	0.19	3	16.000	9038910160000	9038920160000
20.000	20.000	19.500	104.00	38.00	52.00	0.24	3	20.000	9038910200000	9038920200000

# RF 50

## Variable flute end mills for materials < 54 HRC

We have developed the RF 50 end mill with variable flute spacing primarily to prevent chatter and the so-called corkscrew effect (as found when withdrawing tools having a large spiral angle)

However, the variable flute spacing does not only combat these two unwanted effects but offers the following additional advantages:

- Higher feed rates
- Longer tool life
- Increased milling depths
- Vibration-free machining
- Suitable for roughing and finishing
- Increased surface finish quality
- Straighter cutting

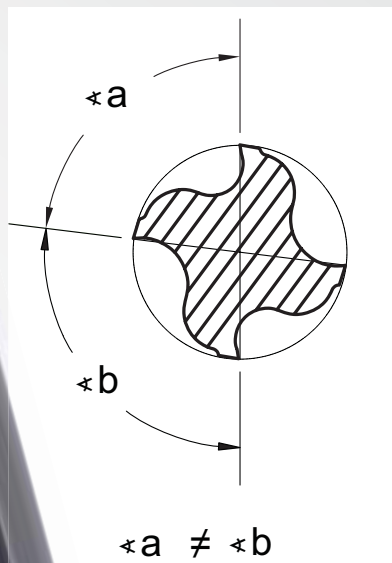

Micro-corner  
protection  
and corrected  
reinforced cutting  
edge = optimal  
stability



# RF 50 (4-flute) - Inch - Stub Length



## center cutting

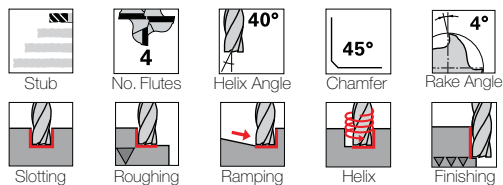

Tool material

**Solid Carbide**

Surface finish

FIREX®

Series

**3095**

Application group	Material examples	Ideal for
<b>P</b>	Steel	●
<b>M</b>	Stainless steel	○
<b>K</b>	Cast iron	●
<b>N</b>	Aluminum	—
<b>S</b>	Ni / Ti alloys	○
<b>H</b>	Hardened steel	○

●=Optimal    ○=Secondary

Speed and Feed data found on page 290

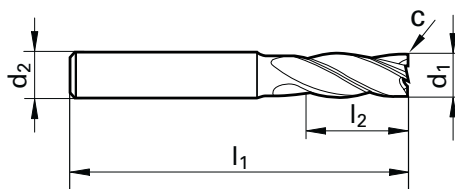

d1 h10	d2 h6	l1	l2	c	No. of Flutes	Code no.	EDP Number
inch	inch	inch	inch	inch x 45°			
3/16	3/16	2	3/8	0.004	4	4.760	9030950047600
1/4	1/4	2	1/2	0.006	4	6.350	9030950063500
5/16	5/16	2	1/2	0.006	4	7.940	9030950079400
3/8	3/8	2	5/8	0.008	4	9.520	9030950095200
1/2	1/2	2 1/2	5/8	0.010	4	12.700	9030950127000
5/8	5/8	3	3/4	0.014	4	15.870	9030950158700
3/4	3/4	3	1	0.018	4	19.050	9030950190500

# RF 50 (4-flute) - Inch - Standard Length



## center cutting

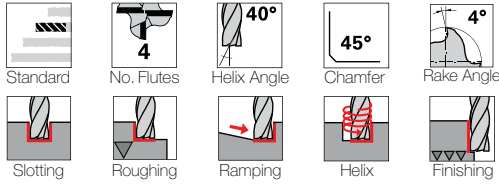

Tool material

**Solid Carbide**

Surface finish

**FIREX®**

Series

**3096**

Application group	Material examples	Ideal for
<b>P</b>	Steel	●
<b>M</b>	Stainless steel	○
<b>K</b>	Cast iron	●
<b>N</b>	Aluminum	—
<b>S</b>	Ni / Ti alloys	○
<b>H</b>	Hardened steel	○

●=Optimal    ○=Secondary

Speed and Feed data found on page 290

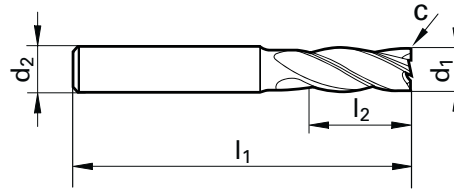

d1 h10	d2 h6	l1	l2	c	No. of Flutes	Code no.	EDP Number
inch	inch	inch	inch	inch x 45°			
3/16	3/16	2	5/8	0.004	4	4.760	9030960047600
1/4	1/4	2 1/2	3/4	0.006	4	6.350	9030960063500
5/16	5/16	2 1/2	13/16	0.006	4	7.940	9030960079400
3/8	3/8	2 1/2	1	0.008	4	9.520	9030960095200
7/16	7/16	2 3/4	1	0.008	4	11.110	9030960111100
1/2	1/2	3	1	0.010	4	12.700	9030960127000
5/8	5/8	3 1/2	1 1/4	0.014	4	15.870	9030960158700
3/4	3/4	4	1 1/2	0.018	4	19.050	9030960190500
1	1	4	1 1/2	0.030	4	25.400	9030960254000



# STEEL

## HARDENED STEEL AND CAST IRON

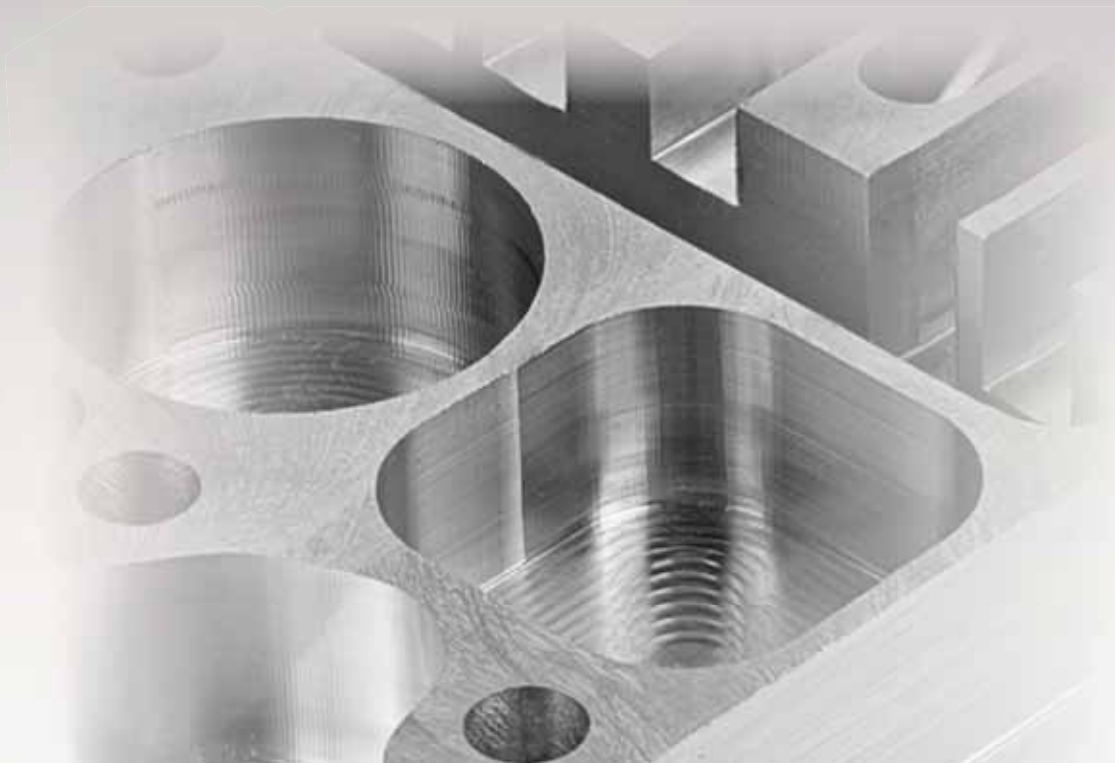

### APPLICATION EXAMPLE

#### HPC roughing

Dry machining in steel SAE 5115

**RF100 U 5/8"; Guhring no. 3099 15.87"**

$a_e = 1.180" / a_p = .157"$

$v_c = 920$  SFM

$f_z = .005$  IPT

$v_f = 113$  IPM

Metal removal rate  $Q = 21$  in<sup>3</sup>/min

#### HPC slotting

Wet machining in steel SAE 4140

**RF100 Diver 7/16"; Guhring no. 6757 11.11"**

$a_e = .7500" / a_p = 1.3750"$

$v_c = 800$  SFM

$f_z = .0035$  IPT

$v_f = 57.05$  IPM

Metal removal rate  $Q = 58$  in<sup>3</sup>/min

# RF 100 U/HF

High-performance roughing end mills for steel and cast materials



RF 100 U/HF · Guhring series 3508

**P M K N S H**

The suitable solution for multiple materials: Steel, cast iron, stainless materials, titanium- and special alloys and aluminum

with neck clearance  
(on select series)

Innovative roughing geometry produces smaller chips, slotting and roughing with large cutting widths and depths, low power consumption and cutting forces therefore suitability on non-rigid machines

HF  
Guh. no. 3507



# RF 100 U/HF (4-flute) - Inch - Standard Length



## center cutting

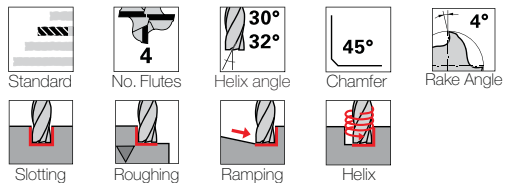

Tool material

**Solid Carbide**

Surface finish

**FIREX®**

Series

**3082**

Application group	Material examples	Ideal for
<b>P</b>	Steel	●
<b>M</b>	Stainless steel	○
<b>K</b>	Cast iron	●
<b>N</b>	Aluminum	—
<b>S</b>	Ni / Ti alloys	○
<b>H</b>	Hardened steel	○

●=Optimal    ○=Secondary

Speed and Feed data found on page 291

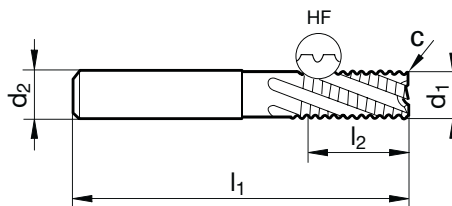

d1 h10	d2 h6	l1	l2	c	No. of Flutes	Code no.	EDP Number
inch	inch	inch	inch	inch x 45°			
1/4	1/4	2 1/2	3/4	0.012	4	6.350	<b>9030820063500</b>
5/16	5/16	2 1/2	13/16	0.012	4	7.940	<b>9030820079400</b>
3/8	3/8	2 1/2	1	0.012	4	9.520	<b>9030820095200</b>
1/2	1/2	3 1/2	1 1/4	0.020	4	12.700	<b>9030820127000</b>
5/8	5/8	3 1/2	1 1/4	0.020	4	15.870	<b>9030820158700</b>
3/4	3/4	4	1 1/2	0.020	4	19.050	<b>9030820190500</b>
1	1	4	1 1/2	0.031	4	25.400	<b>9030820254000</b>

# RF 100 U/HF (4-flute) - Metric - Standard Length



## center cutting

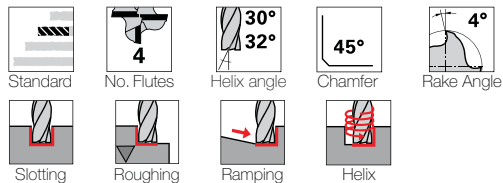

Tool material

Solid Carbide

Surface finish

FIREX®

Series

3507

3508

Application group	Material examples	Ideal for
P	Steel	●
M	Stainless steel	○
K	Cast iron	●
N	Aluminum	—
S	Ni / Ti alloys	○
H	Hardened steel	○

●=Optimal    ○=Secondary

Speed and Feed data found on page 303

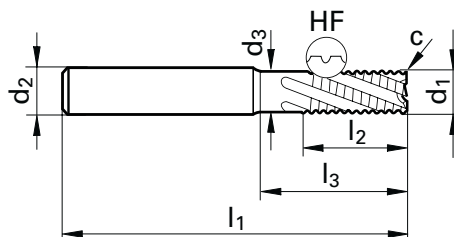

d1 h10	d2 h6	d3	l1	l2	l3	c	No. of Flutes	Code no.	EDP Number	
mm	mm	mm	mm	mm	mm	mm x 45°				
6.000	6.000	5.700	57.00	13.00	20.00	0.30	4	6.000	9035070060000	9035080060000
8.000	8.000	7.700	63.00	19.00	26.00	0.30	4	8.000	9035070080000	9035080080000
10.000	10.000	9.500	72.00	22.00	30.00	0.30	4	10.000	9035070100000	9035080100000
12.000	12.000	11.500	83.00	26.00	36.00	0.50	4	12.000	9035070120000	9035080120000
16.000	16.000	15.500	92.00	32.00	42.00	0.50	4	16.000	9035070160000	9035080160000
20.000	20.000	19.500	104.00	38.00	52.00	0.50	4	20.000	9035070200000	9035080200000
25.000	25.000	24.000	121.00	45.00	63.00	0.60	4	25.000	9035070250000	9035080250000

# RF 100 U/HF (4-flute) - Inch - Long Length

F

## center cutting

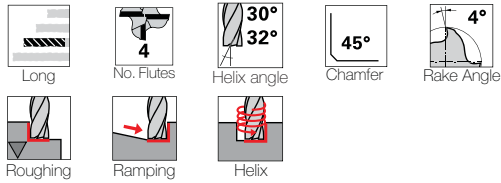

Tool material

**Solid Carbide**

Surface finish

FIREX®

Series

4256

Application group	Material examples	Ideal for
P	Steel	●
M	Stainless steel	○
K	Cast iron	●
N	Aluminum	—
S	Ni / Ti alloys	○
H	Hardened steel	○

●=Optimal    ○=Secondary

Speed and Feed data found on page 291

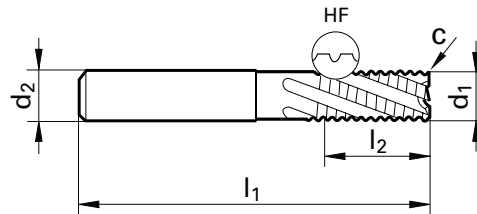

d1 h10	d2 h6	l1	l2	c	No. of Flutes	Code no.	EDP Number
inch	inch	inch	inch	inch x 45°			
1/4	1/4	3 1/4	1 1/4	0.012	4	6.350	9042560063500
5/16	5/16	3 1/4	1 1/2	0.012	4	7.940	9042560079400
3/8	3/8	4	1 3/4	0.012	4	9.520	9042560095200
1/2	1/2	4 1/2	2	0.020	4	12.700	9042560127000
5/8	5/8	5	2 1/4	0.020	4	15.870	9042560158700
3/4	3/4	5	2 1/4	0.020	4	19.050	9042560190500
1	1	5	2 1/4	0.031	4	25.400	9042560254000

# RF 100 U/HF (4-flute) - Metric - XL Long Length (3xD)



## center cutting

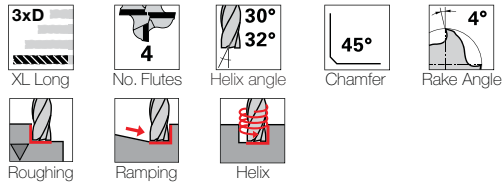

Tool material

**Solid Carbide**

Surface finish

**FIREX®**

Series

**3509**

**3522**

Application group	Material examples	Ideal for
<b>P</b>	Steel	●
<b>M</b>	Stainless steel	○
<b>K</b>	Cast iron	●
<b>N</b>	Aluminum	—
<b>S</b>	Ni / Ti alloys	○
<b>H</b>	Hardened steel	○

●=Optimal    ○=Secondary

Speed and Feed data found on page 303

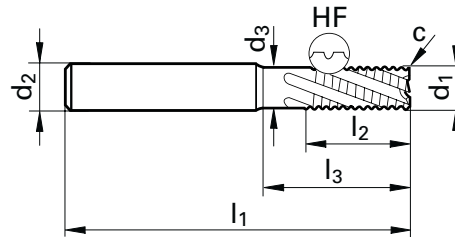

d1 h10	d2 h6	d3	l1	l2	l3	c	No. of Flutes	Code no.	EDP Number	
mm	mm	mm	mm	mm	mm	mm x 45°				
6.000	6.000	5.700	65.00	18.00	28.00	0.30	4	6.000	9035090060000	9035220060000
8.000	8.000	7.700	75.00	24.00	38.00	0.30	4	8.000	9035090080000	9035220080000
10.000	10.000	9.500	80.00	30.00	38.00	0.30	4	10.000	9035090100000	9035220100000
12.000	12.000	11.500	93.00	36.00	46.00	0.50	4	12.000	9035090120000	9035220120000
16.000	16.000	15.500	108.00	48.00	58.00	0.50	4	16.000	9035090160000	9035220160000
20.000	20.000	19.500	126.00	60.00	74.00	0.50	4	20.000	9035090200000	9035220200000

# RF 100 U/HF (4-flute) - Metric - XL Long Length



## center cutting

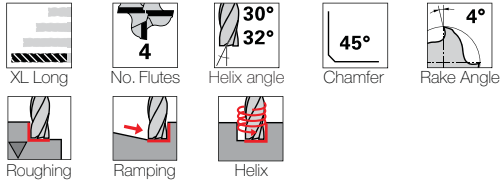

Tool material

**Solid Carbide**

Surface finish

FIREX®

Series

**3598**

**3600**

Application group	Material examples	Ideal for
<b>P</b>	Steel	●
<b>M</b>	Stainless steel	○
<b>K</b>	Cast iron	●
<b>N</b>	Aluminum	—
<b>S</b>	Ni / Ti alloys	○
<b>H</b>	Hardened steel	○

●=Optimal    ○=Secondary

Speed and Feed data found on page 303

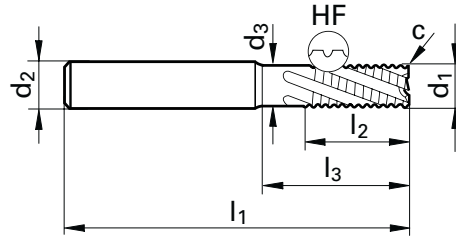

d1 h10	d2 h6	d3	l1	l2	l3	c	No. of Flutes	Code no.	EDP Number	
mm	mm	mm	mm	mm	mm	mm x 45°				
6.000	6.000	5.700	75.00	13.00	34.00	0.30	4	6.000	9035980060000	9036000060000
8.000	8.000	7.700	100.00	19.00	49.00	0.30	4	8.000	9035980080000	9036000080000
10.000	10.000	9.500	100.00	22.00	48.00	0.30	4	10.000	9035980100000	9036000100000
12.000	12.000	11.500	150.00	26.00	58.00	0.50	4	12.000	9035980120000	9036000120000
16.000	16.000	15.500	150.00	32.00	78.00	0.50	4	16.000	9035980160000	9036000160000
20.000	20.000	19.500	150.00	38.00	78.00	0.50	4	20.000	9035980200000	9036000200000

# RF 100 F

RF 100 F high-performance roughing end mills for materials up to 850 N/mm<sup>2</sup> (25 HRC)

RF 100 F high-performance end mills excel thanks to variable helix angles which considerably reduce vibration. The uneven helix angle vastly improves surface quality for finishing operations and a considerably higher feed rate for slot drilling and roughing operations are also achieved.

With many applications, the complete milling process can be covered with one RF 100 F. which as well as increasing tool life and dimensional accuracy of the workpiece generates a considerable cost advantage.

RF 100 S/F · Guhring series 6709

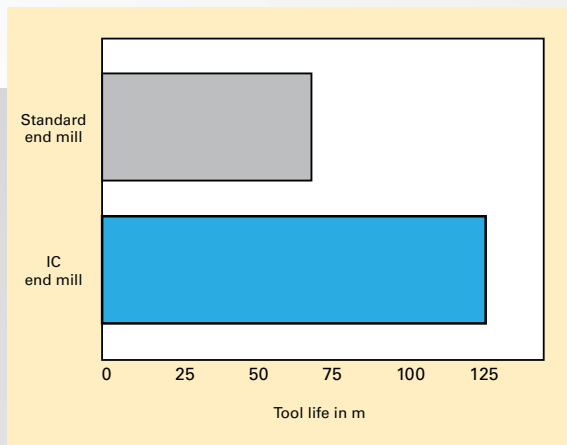
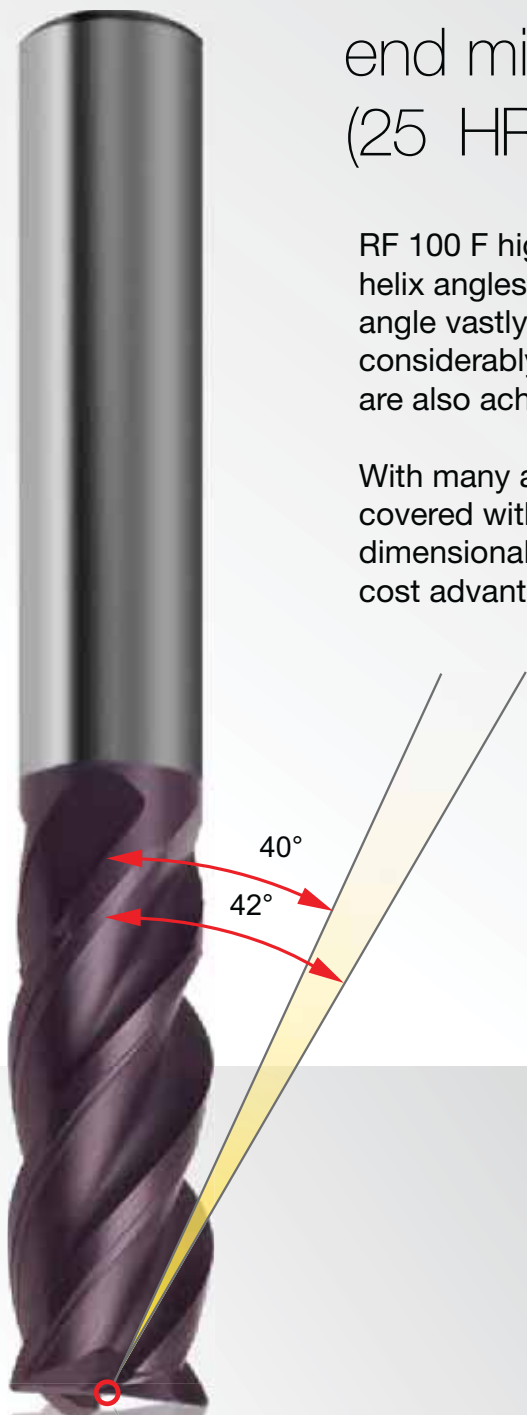

Tool life comparison between end mills with internal cooling and conventional end mills without internal cooling with roughing operations in tool steel.



# RF 100 F (4-flute) - Inch - Standard Length



## center cutting

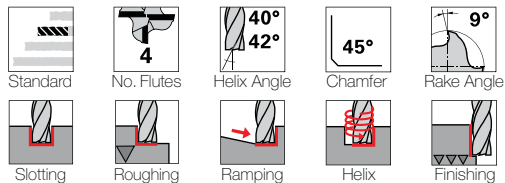

Tool material

**Solid Carbide**

Surface finish

FIREX®

Series

**3078**

Application group	Material examples	Ideal for
P	Steel	●
M	Stainless steel	●
K	Cast iron	○
N	Aluminum	—
S	Ni / Ti alloys	●
H	Hardened steel	—

●=Optimal    ○=Secondary

Speed and Feed data found on page 290

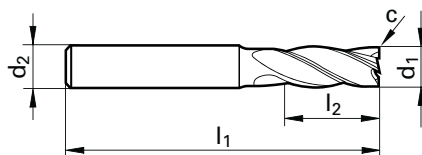

d1 h10	d2 h6	l1	l2	c	No. of Flutes	Code no.	EDP Number
inch	inch	inch	inch	inch x 45°			
3/16	3/16	2	5/8	0.004	4	4.760	<b>9030780047600</b>
1/4	1/4	2 1/2	3/4	0.006	4	6.350	<b>9030780063500</b>
5/16	5/16	2 1/2	13/16	0.006	4	7.940	<b>9030780079400</b>
3/8	3/8	2 1/2	1	0.008	4	9.520	<b>9030780095200</b>
1/2	1/2	3 1/2	1 1/4	0.010	4	12.700	<b>9030780127000</b>
5/8	5/8	3 1/2	1 1/4	0.014	4	15.870	<b>9030780158700</b>
3/4	3/4	4	1 1/2	0.018	4	19.050	<b>9030780190500</b>

# RF 100 F (4-flute) - Metric - Standard Length



## center cutting

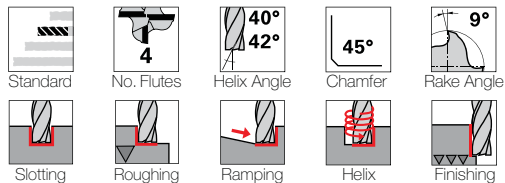

Tool material

Solid Carbide

Surface finish

FIREX®

Series

3629

3630

Application group	Material examples	Ideal for
P	Steel	●
M	Stainless steel	●
K	Cast iron	○
N	Aluminum	—
S	Ni / Ti alloys	●
H	Hardened steel	—

●=Optimal    ○=Secondary

Speed and Feed data found on page 302

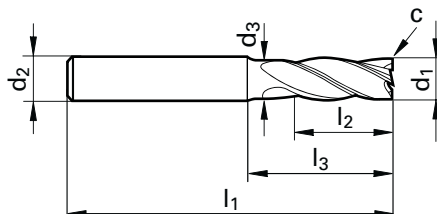

d1 h10	d2 h6	d3	l1	l2	l3	c	No. of Flutes	Code no.	EDP Number	
mm	mm	mm	mm	mm	mm	mm x 45°				
4.000	6.000	3.800	57.00	11.00	18.00	0.10	4	4.000	9036290040000	9036300040000
5.000	6.000	4.800	57.00	13.00	18.00	0.10	4	5.000	9036290050000	9036300050000
6.000	6.000	5.700	57.00	13.00	20.00	0.15	4	6.000	9036290060000	9036300060000
8.000	8.000	7.700	63.00	19.00	26.00	0.15	4	8.000	9036290080000	9036300080000
10.000	10.000	9.500	72.00	22.00	30.00	0.20	4	10.000	9036290100000	9036300100000
12.000	12.000	11.500	83.00	26.00	36.00	0.20	4	12.000	9036290120000	9036300120000
16.000	16.000	15.500	92.00	32.00	42.00	0.35	4	16.000	9036290160000	9036300160000
20.000	20.000	19.500	104.00	38.00	52.00	0.45	4	20.000	9036290200000	9036300200000

# RF 100 F (4-flute) - Metric - Standard Length - Coolant Through



F

## center cutting



Standard



No. Flutes



Helix Angle



Chamfer



Rake Angle



Slotting



Roughing



Ramping



Helix



Finishing



Tool material

Solid Carbide

Surface finish

FIREX®

Series

3366

Application group	Material examples	Ideal for
P	Steel	●
M	Stainless steel	●
K	Cast iron	○
N	Aluminum	—
S	Ni / Ti alloys	●
H	Hardened steel	—

●=Optimal ○=Secondary

Speed and Feed data found on page 302

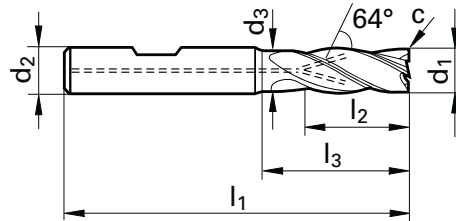

d1 h10	d2 h6	d3	l1	l2	l3	c	No. of Flutes	Code no.	EDP Number
mm	mm	mm	mm	mm	mm	mm x 45°			
6.000	6.000	5.700	57.00	13.00	20.00	0.15	4	6.000	9033660060000
8.000	8.000	7.700	63.00	19.00	26.00	0.15	4	8.000	9033660080000
10.000	10.000	9.500	72.00	22.00	30.00	0.20	4	10.000	9033660100000
12.000	12.000	11.500	83.00	26.00	36.00	0.20	4	12.000	9033660120000
16.000	16.000	15.500	92.00	32.00	42.00	0.35	4	16.000	9033660160000
20.000	20.000	19.500	104.00	38.00	52.00	0.45	4	20.000	9033660200000

# RF 100 VA

## High-performance end mills for stainless steel

### Summary of advantages

- Roughing and plain version
- Wide range of geometries
- Full size and under size availability
- Different lengths and cutting edge designs including ball-nose and roughing geometry
- For slotting, roughing, copying and finishing operations in VA steels and stainless steels
- Improved chip evacuation and reduced machining temperature thanks to optimized flute geometry
- High contour accuracy and minimum deflection
- Applicable with long projection lengths

RF 100 VA - Guhring series 4257



also available as ball nosed

# RF 100 VA (4-flute) - Inch - Stub Length



## center cutting

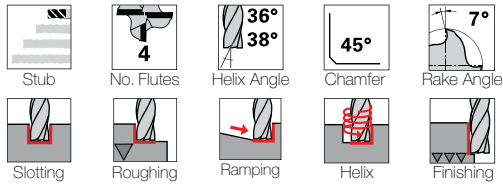

Tool material

**Solid Carbide**

Surface finish

nano-A™

Series

**4257**

Application group	Material examples	Ideal for
<b>P</b>	Steel	●
<b>M</b>	Stainless steel	●
<b>K</b>	Cast iron	○
<b>N</b>	Aluminum	—
<b>S</b>	Ni / Ti alloys	●
<b>H</b>	Hardened steel	—

●=Optimal    ○=Secondary

Speed and Feed data found on page 290

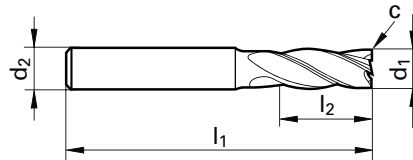

d1 h10	d2 h6	l1	l2	c	No. of Flutes	Code no.	EDP Number
inch	inch	inch	inch	inch x 45°			
1/8	1/8	1 1/2	1/4	0.004	4	3.170	9042570031700
3/16	3/16	2	3/8	0.006	4	4.760	9042570047600
1/4	1/4	2	1/2	0.010	4	6.350	9042570063500
5/16	5/16	2	1/2	0.010	4	7.940	9042570079400
3/8	3/8	2	5/8	0.012	4	9.520	9042570095200
1/2	1/2	2 1/2	5/8	0.016	4	12.700	9042570127000
5/8	5/8	3	3/4	0.020	4	15.870	9042570158700
3/4	3/4	3	1	0.024	4	19.050	9042570190500

# RF 100 VA (4-flute) - Metric - Stub Length



## center cutting

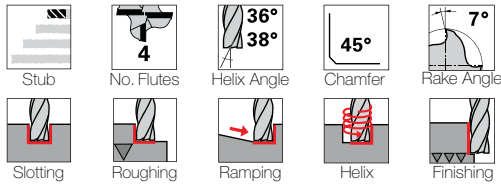

Tool material

Solid Carbide

Surface finish

nano-A™

Series

3804

3805

Application group	Material examples	Ideal for
P	Steel	●
M	Stainless steel	●
K	Cast iron	○
N	Aluminum	—
S	Ni / Ti alloys	●
H	Hardened steel	—

●=Optimal ○=Secondary

Speed and Feed data found on page 302

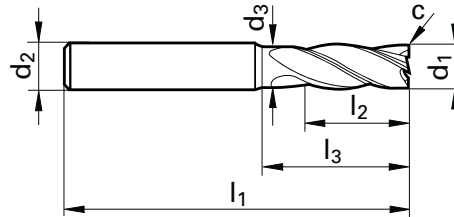

d1 h10	d2 h6	d3	l1	l2	l3	c	No. of Flutes	Code no.	EDP Number	
mm	mm	mm	mm	mm	mm	mm x 45°				
4.000	6.000	3.800	54.00	8.00	15.00	0.15	4	4.000	9038040040000	9038050040000
5.000	6.000	4.800	54.00	9.00	15.00	0.15	4	5.000	9038040050000	9038050050000
6.000	6.000	5.700	54.00	10.00	17.00	0.20	4	6.000	9038040060000	9038050060000
8.000	8.000	7.700	58.00	12.00	21.00	0.25	4	8.000	9038040080000	9038050080000
10.000	10.000	9.500	66.00	14.00	24.00	0.30	4	10.000	9038040100000	9038050100000
12.000	12.000	11.500	73.00	16.00	26.00	0.35	4	12.000	9038040120000	9038050120000
16.000	16.000	15.500	82.00	22.00	32.00	0.50	4	16.000	9038040160000	9038050160000
20.000	20.000	19.500	92.00	26.00	40.00	0.60	4	20.000	9038040200000	9038050200000

# RF 100 VA (4-flute) - Inch - Standard Length

a

## center cutting

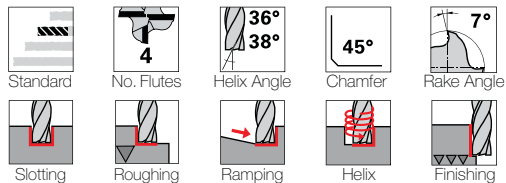

Tool material

**Solid Carbide**

Surface finish

nano-A™

Series

**3080**

Application group	Material examples	Ideal for
P	Steel	●
M	Stainless steel	●
K	Cast iron	○
N	Aluminum	—
S	Ni / Ti alloys	●
H	Hardened steel	—

●=Optimal    ○=Secondary

Speed and Feed data found on page 290

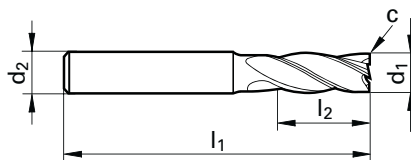

d1 h10	d2 h6	l1	l2	c	No. of Flutes	Code no.	EDP Number
inch	inch	inch	inch	inch x 45°			
1/8	1/8	2	1/2	0.004	4	3.170	9030800031700
3/16	3/16	2	5/8	0.006	4	4.760	9030800047600
1/4	1/4	2 1/2	3/4	0.010	4	6.350	9030800063500
5/16	5/16	2 1/2	13/16	0.010	4	7.940	9030800079400
3/8	3/8	2 1/2	1	0.012	4	9.520	9030800095200
1/2	1/2	3 1/2	1 1/4	0.016	4	12.700	9030801127000 9030800127000
5/8	5/8	3 1/2	1 1/4	0.020	4	15.870	9030801158700 9030800158700
3/4	3/4	4	1 1/2	0.024	4	19.050	9030801190500 9030800190500
1	1	4	1 1/2	0.035	4	25.400	9030801254000 9030800254000

# RF 100 VA (4-flute) - Inch - Standard Length



## center cutting

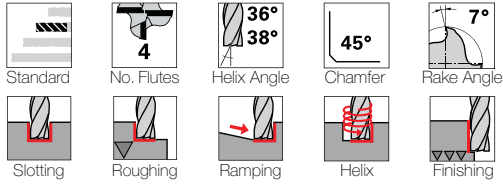

Tool material

**Solid Carbide**

Surface finish

nano-Si®

Series

**3053**

Application group	Material examples	Ideal for
<b>P</b>	Steel	●
<b>M</b>	Stainless steel	●
<b>K</b>	Cast iron	○
<b>N</b>	Aluminum	—
<b>S</b>	Ni / Ti alloys	●
<b>H</b>	Hardened steel	—

●=Optimal    ○=Secondary

Speed and Feed data found on page 290

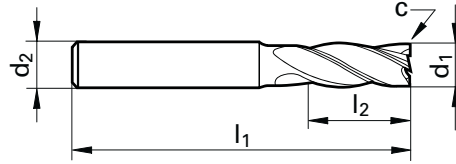

d1 h10	d2 h6	l1	l2	c	No. of Flutes	Code no.	EDP Number
inch	inch	inch	inch	inch x 45°			
1/8	1/8	2	3/8	0.004	4	3.170	9030530031700
3/16	3/16	2	5/8	0.006	4	4.760	9030530047600
1/4	1/4	2 1/2	3/4	0.010	4	6.350	9030530063500
5/16	5/16	2 1/2	13/16	0.010	4	7.940	9030530079400
3/8	3/8	2 1/2	1	0.012	4	9.520	9030530095200
1/2	1/2	3 1/2	1 1/4	0.016	4	12.700	9030530127000
5/8	5/8	3 1/2	1 1/4	0.020	4	15.870	9030530158700
3/4	3/4	4	1 1/2	0.024	4	19.050	9030530190500
1	1	4	1 1/2	0.035	4	25.400	9030530254000



# RF 100 VA (4-flute) - Metric - Standard Length



## center cutting

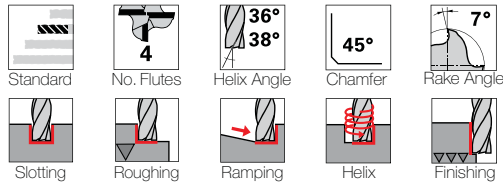

Tool material

Solid Carbide

Surface finish

nano-A™

Series

3800

3803

Application group	Material examples	Ideal for
P	Steel	●
M	Stainless steel	●
K	Cast iron	○
N	Aluminum	—
S	Ni / Ti alloys	●
H	Hardened steel	—

●=Optimal    ○=Secondary

Speed and Feed data found on page 302

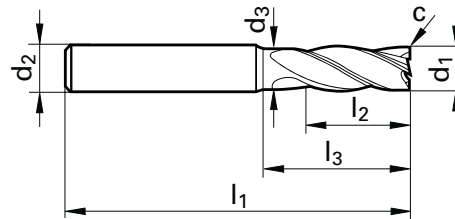

d1 h10	d2 h6	d3	l1	l2	l3	c	No. of Flutes	Code no.	EDP Number	
mm	mm	mm	mm	mm	mm	mm x 45°				
3.000	6.000	2.800	57.00	8.00	15.00	0.10	4	3.000	9038000030000	9038030030000
3.500	6.000	3.300	57.00	10.00	15.00	0.10	4	3.500	9038000035000	9038030035000
4.000	6.000	3.800	57.00	11.00	18.00	0.15	4	4.000	9038000040000	9038030040000
4.500	6.000	4.300	57.00	11.00	18.00	0.15	4	4.500	9038000045000	9038030045000
5.000	6.000	4.800	57.00	13.00	18.00	0.15	4	5.000	9038000050000	9038030050000
5.500	6.000	5.300	57.00	13.00	20.40	0.20	4	5.500	9038000055000	9038030055000
6.000	6.000	5.700	57.00	13.00	20.00	0.20	4	6.000	9038000060000	9038030060000
6.500	8.000	6.200	63.00	16.00	24.40	0.25	4	6.500	9038000065000	9038030065000
7.000	8.000	6.700	63.00	16.00	24.90	0.25	4	7.000	9038000070000	9038030070000
7.500	8.000	7.200	63.00	19.00	25.30	0.25	4	7.500	9038000075000	9038030075000
8.000	8.000	7.700	63.00	19.00	26.00	0.25	4	8.000	9038000080000	9038030080000
8.500	10.000	8.200	72.00	19.00	29.40	0.30	4	8.500	9038000085000	9038030085000
9.000	10.000	8.700	72.00	19.00	29.90	0.30	4	9.000	9038000090000	9038030090000
9.500	10.000	9.200	72.00	22.00	30.30	0.30	4	9.500	9038000095000	9038030095000
10.000	10.000	9.500	72.00	22.00	30.00	0.30	4	10.000	9038000100000	9038030100000
11.000	12.000	10.500	83.00	26.00	34.70	0.35	4	11.000	9038000110000	9038030110000
12.000	12.000	11.500	83.00	26.00	36.00	0.35	4	12.000	9038000120000	9038030120000
14.000	14.000	13.500	83.00	26.00	36.00	0.40	4	14.000	9038000140000	9038030140000
16.000	16.000	15.500	92.00	32.00	42.00	0.50	4	16.000	9038000160000	9038030160000
18.000	18.000	17.500	92.00	32.00	42.00	0.60	4	18.000	9038000180000	9038030180000
20.000	20.000	19.500	104.00	38.00	52.00	0.60	4	20.000	9038000200000	9038030200000
25.000	25.000	24.000	121.00	45.00	63.00	0.75	4	25.000	9038000250000	9038030250000

# RF 100 VA (4-flute) - Metric - Standard Length - Coolant Through



a

## center cutting



Standard



No. Flutes



Helix Angle



Chamfer



Rake Angle



Slotting



Roughing



Ramping



Helix



Finishing



HA



HB

Tool material

Solid Carbide

Surface finish

nano-A™

Series

6700

6701

Application group	Material examples	Ideal for
P	Steel	●
M	Stainless steel	●
K	Cast iron	○
N	Aluminum	—
S	Ni / Ti alloys	●
H	Hardened steel	—

●=Optimal ○=Secondary

Speed and Feed data found on page 302

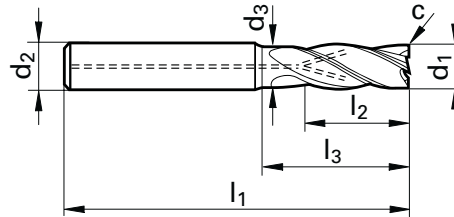

d1 h10	d2 h6	d3	l1	l2	l3	c	No. of Flutes	Code no.	EDP Number	
mm	mm	mm	mm	mm	mm	mm x 45°				
6.000	6.000	5.700	57.00	13.00	20.00	0.20	4	6.000	9067000060000	9067010060000
8.000	8.000	7.700	63.00	19.00	26.00	0.25	4	8.000	9067000080000	9067010080000
10.000	10.000	9.500	72.00	22.00	30.00	0.30	4	10.000	9067000100000	9067010100000
12.000	12.000	11.500	83.00	26.00	36.00	0.35	4	12.000	9067000120000	9067010120000
16.000	16.000	15.500	92.00	32.00	42.00	0.50	4	16.000	9067000160000	9067010160000
20.000	20.000	19.500	104.00	38.00	52.00	0.60	4	20.000	9067000200000	9067010200000
25.000	25.000	24.000	121.00	45.00	63.00	0.75	4	25.000	9067000250000	9067010250000

# RF 100 VA (4-flute) - Inch - Long Length



## center cutting

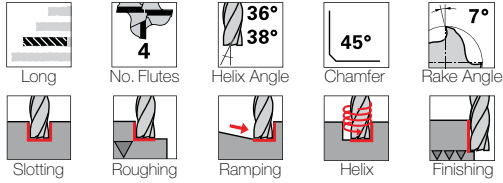

Tool material

**Solid Carbide**

Surface finish

nano-A™

Series

**4260**

Application group	Material examples	Ideal for
<b>P</b>	Steel	●
<b>M</b>	Stainless steel	●
<b>K</b>	Cast iron	○
<b>N</b>	Aluminum	—
<b>S</b>	Ni / Ti alloys	●
<b>H</b>	Hardened steel	—

●=Optimal    ○=Secondary

Speed and Feed data found on page 290

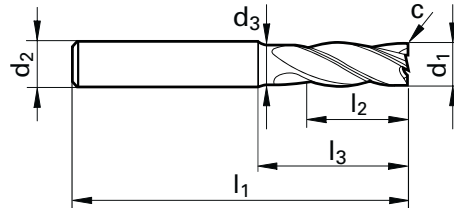

d1 h10	d2 h6	d3	l1	l2	l3	c	No. of Flutes	Code no.	EDP Number
inch	inch	inch	inch	inch	inch	inch x 45°			
3/16	3/16	0.176	2 1/2	5/8	1	0.006	4	4.760	<b>9042600047600</b>
1/4	1/4	0.230	3 1/4	3/4	1 3/4	0.010	4	6.350	<b>9042600063500</b>
5/16	5/16	0.293	3 1/4	13/16	1 3/4	0.010	4	7.940	<b>9042600079400</b>
3/8	3/8	0.355	4	1	2 1/4	0.012	4	9.520	<b>9042600095200</b>
1/2	1/2	0.469	4 1/2	1 1/4	2 1/2	0.016	4	12.700	<b>9042600127000</b>
5/8	5/8	0.594	5	1 1/4	2 1/2	0.020	4	15.870	<b>9042600158700</b>
3/4	3/4	0.711	5	1 1/2	2 1/2	0.024	4	19.050	<b>9042600190500</b>
1	1	0.941	5	1 1/2	2 5/8	0.035	4	25.400	<b>9042600254000</b>

# RF 100 VA (4-flute) - Inch - Long Length

a

## center cutting

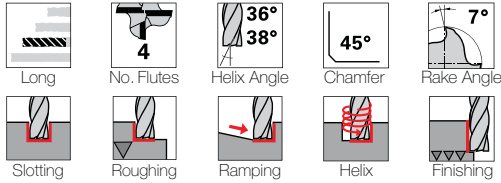

Tool material

Solid Carbide

Surface finish

nano-ATM

Series

4258

Application group	Material examples	Ideal for
P	Steel	●
M	Stainless steel	●
K	Cast iron	○
N	Aluminum	—
S	Ni / Ti alloys	●
H	Hardened steel	—

●=Optimal    ○=Secondary

Speed and Feed data found on page 290

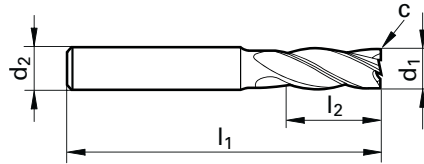

d1 h10	d2 h6	l1	l2	c	No. of Flutes	Code no.	EDP Number
inch	inch	inch	inch	inch x 45°			
3/16	3/16	2 1/2	3/4	0.006	4	4.760	9042580047600
1/4	1/4	3 1/4	1 1/4	0.010	4	6.350	9042580063500
5/16	5/16	3 1/4	1 1/2	0.010	4	7.940	9042580079400
3/8	3/8	4	1 3/4	0.012	4	9.520	9042580095200
1/2	1/2	4 1/2	2	0.016	4	12.700	9042580127000
5/8	5/8	5	2 1/4	0.020	4	15.870	9042580158700
3/4	3/4	5	2 1/4	0.024	4	19.050	9042580190500
1	1	5	2 1/4	0.035	4	25.400	9042580254000

# RF 100 VA (4-flute) - Metric - Long Length



## center cutting

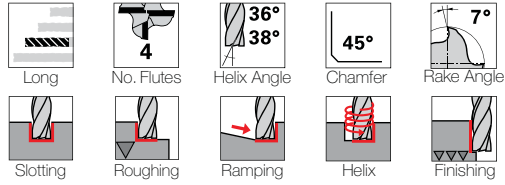

Tool material

**Solid Carbide**

Surface finish

nano-A™

Series

**3806**

**3807**

Application group	Material examples	Ideal for
<b>P</b>	Steel	●
<b>M</b>	Stainless steel	●
<b>K</b>	Cast iron	○
<b>N</b>	Aluminum	—
<b>S</b>	Ni / Ti alloys	●
<b>H</b>	Hardened steel	—

●=Optimal    ○=Secondary

Speed and Feed data found on page 302

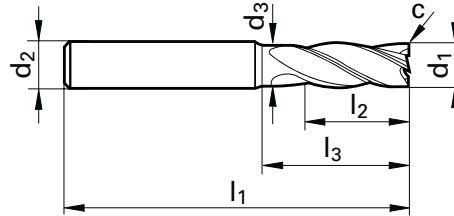

d1 h10	d2 h6	d3	l1	l2	l3	c	No. of Flutes	Code no.	EDP Number	
mm	mm	mm	mm	mm	mm	mm x 45°				
6.000	6.000	5.700	65.00	10.00	28.00	0.20	4	6.000	9038060060000	9038070060000
8.000	8.000	7.700	75.00	12.00	38.00	0.25	4	8.000	9038060080000	9038070080000
10.000	10.000	9.500	80.00	14.00	38.00	0.30	4	10.000	9038060100000	9038070100000
12.000	12.000	11.500	93.00	16.00	46.00	0.35	4	12.000	9038060120000	9038070120000
16.000	16.000	15.500	108.00	22.00	58.00	0.50	4	16.000	9038060160000	9038070160000
20.000	20.000	19.500	126.00	26.00	74.00	0.60	4	20.000	9038060200000	9038070200000

# RF 100 VA (4-flute) - Inch - XL Long Length



## center cutting

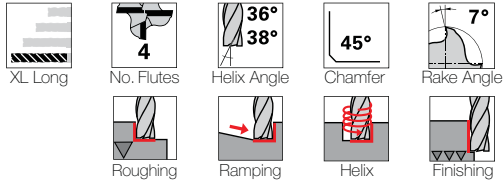

Tool material

**Solid Carbide**

Surface finish

nano-A™

Series

**4259**

Application group	Material examples	Ideal for
P	Steel	●
M	Stainless steel	●
K	Cast iron	○
N	Aluminum	—
S	Ni / Ti alloys	●
H	Hardened steel	—

●=Optimal    ○=Secondary

Speed and Feed data found on page 290

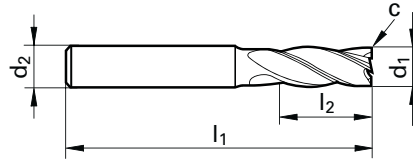

d1 h10	d2 h6	l1	l2	c	No. of Flutes	Code no.	EDP Number
inch	inch	inch	inch	inch x 45°			
1/4	1/4	4	1 3/4	0.010	4	6.350	9042590063500
5/16	5/16	4	1 3/4	0.010	4	7.940	9042590079400
3/8	3/8	4	2 1/4	0.012	4	9.520	9042590095200
1/2	1/2	5	3	0.016	4	12.700	9042590127000
5/8	5/8	6	3	0.020	4	15.870	9042590158700
3/4	3/4	6	3 1/8	0.024	4	19.050	9042590190500
1	1	6	3 1/8	0.035	4	25.400	9042590254000

# RF 100 VA Ball Nose (4-flute) - Inch - Standard Length



## center cutting

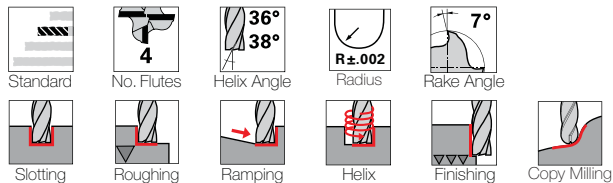

Tool material

**Solid Carbide**

Surface finish

nano-A™

Series

**4261**

Application group	Material examples	Ideal for
<b>P</b>	Steel	●
<b>M</b>	Stainless steel	●
<b>K</b>	Cast iron	○
<b>N</b>	Aluminum	—
<b>S</b>	Ni / Ti alloys	●
<b>H</b>	Hardened steel	—

●=Optimal    ○=Secondary

Speed and Feed data found on page 290

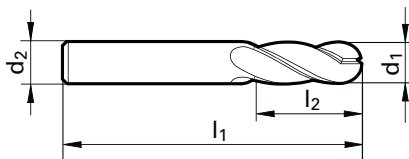

d1 h10	d2 h6	l1	l2	No. of Flutes	Code no.	EDP Number
inch	inch	inch	inch			
1/8	1/8	2	1/2	4	3.170	<b>9042610031700</b>
3/16	3/16	2	5/8	4	4.760	<b>9042610047600</b>
1/4	1/4	2 1/2	3/4	4	6.350	<b>9042610063500</b>
5/16	5/16	2 1/2	13/16	4	7.940	<b>9042610079400</b>
3/8	3/8	2 1/2	1	4	9.520	<b>9042610095200</b>
7/16	7/16	2 3/4	1	4	11.110	<b>9042610111100</b>
1/2	1/2	3 1/2	1 1/4	4	12.700	<b>9042610127000</b>
5/8	5/8	3 1/2	1 1/4	4	15.870	<b>9042610158700</b>
3/4	3/4	4	1 1/2	4	19.050	<b>9042610190500</b>
1	1	4	1 1/2	4	25.400	<b>9042610254000</b>

# RF 100 VA Ball Nose (4-flute) - Metric - Standard Length



## center cutting

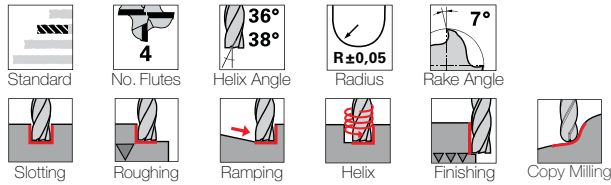

Tool material

**Solid Carbide**

Surface finish

nano-ATM

Series

**6707**

**6708**

Application group	Material examples	Ideal for
<b>P</b>	Steel	●
<b>M</b>	Stainless steel	●
<b>K</b>	Cast iron	○
<b>N</b>	Aluminum	—
<b>S</b>	Ni / Ti alloys	●
<b>H</b>	Hardened steel	—

●=Optimal    ○=Secondary

Speed and Feed data found on page 302

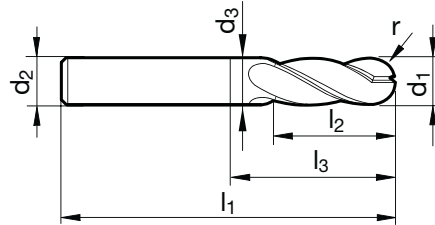

d1 h10	d2 h6	d3	l1	l2	l3	No. of Flutes	Code no.	EDP Number	
mm	mm	mm	mm	mm	mm				
4.000	6.000	3.800	57.00	11.00	18.00	4	4.000	9067070040000	9067080040000
5.000	6.000	4.800	57.00	13.00	18.00	4	5.000	9067070050000	9067080050000
6.000	6.000	5.700	57.00	13.00	20.00	4	6.000	9067070060000	9067080060000
8.000	8.000	7.700	63.00	19.00	26.00	4	8.000	9067070080000	9067080080000
10.000	10.000	9.500	72.00	22.00	30.00	4	10.000	9067070100000	9067080100000
12.000	12.000	11.500	83.00	26.00	36.00	4	12.000	9067070120000	9067080120000
16.000	16.000	15.500	92.00	32.00	42.00	4	16.000	9067070160000	9067080160000
20.000	20.000	19.500	104.00	38.00	52.00	4	20.000	9067070200000	9067080200000
25.000	25.000	24.000	121.00	45.00	63.00	4	25.000	9067070250000	9067080250000



# STAINLESS

## SPECIAL ALLOYS



### APPLICATION EXAMPLE

#### HPC roughing

Wet machining in SAE 316L

**RF100 VA 1/2"; Guhring no.: 3080 12.7**

$a_e = .945" / a_p = .047"$

$v_c = 394$  SFM

$f_z = 0.0039$  IPT

$v_f = 50$  IPM

Metal removal rate  $Q = 2.22$  in<sup>3</sup>/min

#### Slot milling

Wet machining in SAE 304

**RF100 VA 5/8"; Guhring no.: 4257 15.87"**

$a_e = .625" / a_p = .625"$

$v_c = 279$  SFM

$f_z = 0.0024$  IPT

$v_f = 16$  IPM

Metal removal rate  $Q = 6.25$  in<sup>3</sup>/min

# RF 100 VA/NF

## high-performance roughing end mills for stainless steels

Based on our RF 100 end mill now with variable helix angles in combination with a newly developed roughing geometry. The result is a dramatic increase in tool life in comparison to conventional rough milling cutters with round or flat knuckle-type teeth. At the same time, the surface quality of the workpiece is improved to a peak-to-valley height of appr.  $R_a = 2-3 \mu\text{m}$ , making finishing operations unnecessary in many cases.

At the same time the innovative design reduces power consumption in comparison to conventional RF 100 end mills allowing the application in unstable conditions and on less powerful machines.

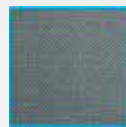

Workpiece surface  
 $R_a = 2-3 \mu\text{m}$

- decreased cutting pressure and power consumption
- vibration-free operation
- increased feed rates possible
- increased surface qualities ( $R_a = 2-3 \mu\text{m}$ )
- improved tool life

with neck clearance  
(on select series)

36°  
38°



with micro-corner protection for  
longer tool life

RF 100 VA/NF - Guhring series 3718

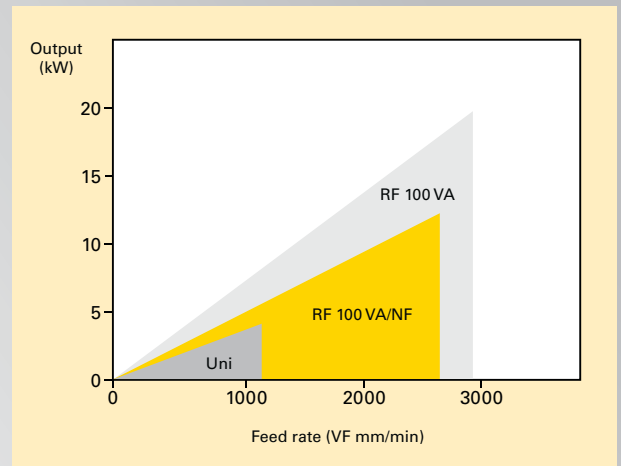

# RF 100 VA/NF (4-flute) - Inch - Standard Length

a

## center cutting

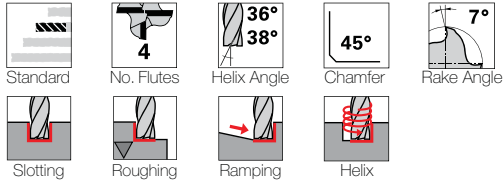

Tool material

**Solid Carbide**

Surface finish

nano-A™

Series

**3081**

Application group	Material examples	Ideal for
P	Steel	●
M	Stainless steel	●
K	Cast iron	○
N	Aluminum	—
S	Ni / Ti alloys	●
H	Hardened steel	—

●=Optimal    ○=Secondary

Speed and Feed data found on page 291

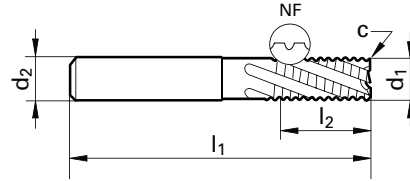

d1 h10	d2 h6	l1	l2	c	No. of Flutes	Code no.	EDP Number
inch	inch	inch	inch	inch x 45°			
1/4	1/4	2 1/2	3/4	0.012	4	6.350	9030810063500
5/16	5/16	2 1/2	13/16	0.012	4	7.940	9030810079400
3/8	3/8	2 1/2	1	0.012	4	9.520	9030810095200
1/2	1/2	3 1/2	1 1/4	0.020	4	12.700	9030810127000
5/8	5/8	3 1/2	1 1/4	0.020	4	15.870	9030810158700
3/4	3/4	4	1 1/2	0.020	4	19.050	9030810190500
1	1	4	1 1/2	0.031	4	25.400	9030810254000

# RF 100 VA/NF (4-flute) - Inch - Standard Length



## center cutting

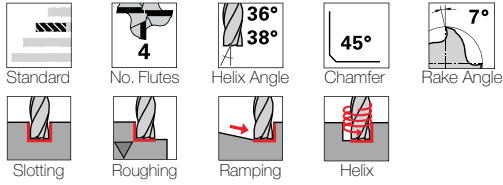

Tool material

**Solid Carbide**

Surface finish

nano-Si®

Series

**3060**

Application group	Material examples	Ideal for
<b>P</b>	Steel	●
<b>M</b>	Stainless steel	●
<b>K</b>	Cast iron	○
<b>N</b>	Aluminum	—
<b>S</b>	Ni / Ti alloys	●
<b>H</b>	Hardened steel	—

●=Optimal    ○=Secondary

Speed and Feed data found on page 291

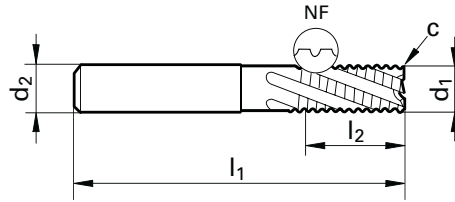

d1 h10	d2 h6	l1	l2	c	No. of Flutes	Code no.	EDP Number
inch	inch	inch	inch	inch x 45°			
1/4	1/4	2 1/2	3/4	0.012	4	6.350	<b>9030600063500</b>
5/16	5/16	2 1/2	13/16	0.012	4	7.940	<b>9030600079400</b>
3/8	3/8	2 1/2	1	0.012	4	9.520	<b>9030600095200</b>
1/2	1/2	3 1/2	1 1/4	0.020	4	12.700	<b>9030600127000</b>
5/8	5/8	3 1/2	1 1/4	0.020	4	15.870	<b>9030600158700</b>
3/4	3/4	4	1 1/2	0.020	4	19.050	<b>9030600190500</b>
1	1	4	1 1/2	0.031	4	25.400	<b>9030600254000</b>

# RF 100 VA/NF (4-flute) - Metric - Standard Length

a

## center cutting

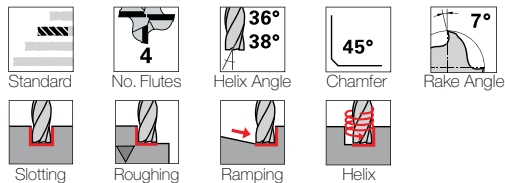

Tool material

**Solid Carbide**

Surface finish

nano-A™

Series

**3696**

**3718**

Application group	Material examples	Ideal for
P	Steel	●
M	Stainless steel	●
K	Cast iron	○
N	Aluminum	—
S	Ni / Ti alloys	●
H	Hardened steel	—

●=Optimal ○=Secondary

Speed and Feed data found on page 303

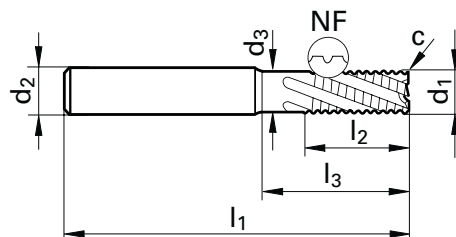

d1 h10	d2 h6	d3	l1	l2	l3	c	No. of Flutes	Code no.	EDP Number	
mm	mm	mm	mm	mm	mm	mm x 45°				
5.000	6.000	4.800	57.00	13.00	18.00	0.20	4	5.000	9036960050000	9037180050000
6.000	6.000	5.700	57.00	13.00	20.00	0.30	4	6.000	9036960060000	9037180060000
7.000	8.000	6.700	63.00	16.00	24.90	0.30	4	7.000	9036960070000	9037180070000
8.000	8.000	7.700	63.00	19.00	26.00	0.30	4	8.000	9036960080000	9037180080000
9.000	10.000	8.700	72.00	19.00	29.90	0.30	4	9.000	9036960090000	9037180090000
10.000	10.000	9.500	72.00	22.00	30.00	0.30	4	10.000	9036960100000	9037180100000
12.000	12.000	11.500	83.00	26.00	36.00	0.50	4	12.000	9036960120000	9037180120000
14.000	14.000	13.500	83.00	26.00	36.00	0.50	4	14.000	9036960140000	9037180140000
16.000	16.000	15.500	92.00	32.00	42.00	0.50	4	16.000	9036960160000	9037180160000
18.000	20.000	17.500	92.00	32.00	42.00	0.50	4	18.000	9036960180000	9037180180000
20.000	20.000	19.500	104.00	38.00	52.00	0.50	4	20.000	9036960200000	9037180200000
25.000	25.000	24.000	121.00	45.00	63.00	0.60	4	25.000	9036960250000	9037180250000

# RF 100 VA/NF (4-flute) - Inch - Long Length

a

## center cutting

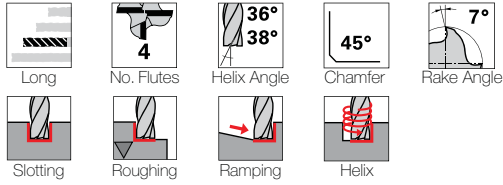

Tool material

**Solid Carbide**

Surface finish

nano-A™

Series

**4262**

Application group	Material examples	Ideal for
P	Steel	●
M	Stainless steel	●
K	Cast iron	○
N	Aluminum	—
S	Ni / Ti alloys	●
H	Hardened steel	—

●=Optimal    ○=Secondary

Speed and Feed data found on page 291

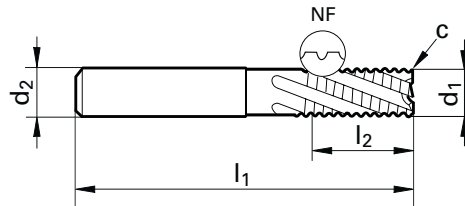

d1 h10	d2 h6	l1	l2	c	No. of Flutes	Code no.	EDP Number
inch	inch	inch	inch	inch x 45°			
1/4	1/4	3 1/4	1 1/4	0.012	4	6.350	9042620063500
5/16	5/16	3 1/4	1 1/2	0.012	4	7.940	9042620079400
3/8	3/8	4	1 3/4	0.012	4	9.520	9042620095200
1/2	1/2	4 1/2	2	0.020	4	12.700	9042620127000
5/8	5/8	5	2 1/4	0.020	4	15.870	9042620158700
3/4	3/4	5	2 1/4	0.020	4	19.050	9042620190500
1	1	5	2 1/4	0.031	4	25.400	9042620254000

# RF 100 VA/NF (4-flute) - Metric - Long Length

a

## center cutting

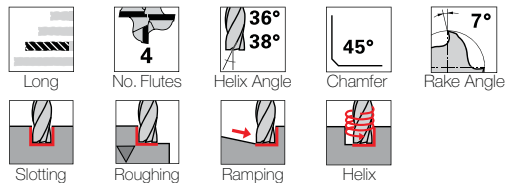

Tool material

Solid Carbide

Surface finish

nano-A™

Series

3733

3885

Application group	Material examples	Ideal for
P	Steel	●
M	Stainless steel	●
K	Cast iron	○
N	Aluminum	—
S	Ni / Ti alloys	●
H	Hardened steel	—

●=Optimal    ○=Secondary

Speed and Feed data found on page 303

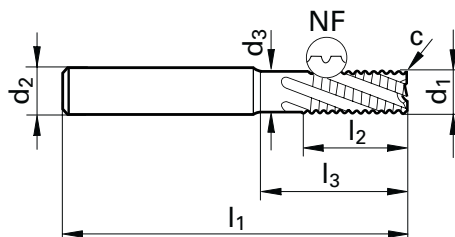

d1 h10	d2 h6	d3	l1	l2	l3	c	No. of Flutes	Code no.	EDP Number	
mm	mm	mm	mm	mm	mm	mm x 45°				
6.000	6.000	5.700	65.00	10.00	28.00	0.30	4	6.000	9037330060000	9038850060000
8.000	8.000	7.700	75.00	12.00	38.00	0.30	4	8.000	9037330080000	9038850080000
10.000	10.000	9.500	80.00	14.00	38.00	0.30	4	10.000	9037330100000	9038850100000
12.000	12.000	11.500	93.00	16.00	46.00	0.50	4	12.000	9037330120000	9038850120000
16.000	16.000	15.500	108.00	22.00	58.00	0.50	4	16.000	9037330160000	9038850160000
20.000	20.000	19.500	126.00	26.00	74.00	0.50	4	20.000	9037330200000	9038850200000

# RF 100 A

## High-performance roughing end mills for aluminum and Al-alloys

RF 100 high-performance end mills excel thanks to variable helix angles which considerably reduce vibration. The uneven helix angle vastly improves surface quality for finishing operations and a considerably higher feed rate for slot drilling and roughing operations are also achieved.

With many applications, the complete milling process can be covered with one RF 100, which as well as increasing tool life and dimensional accuracy of the workpiece generates a considerable cost advantage.

RF 100 A · Guhring series 3077

with neck clearance  
(on select series)

40°

42°

- suitable for roughing and finishing
- up to 60% higher feed rates
- up to 4-times longer tool life
- vibration-free operation
- improved workpiece surface quality

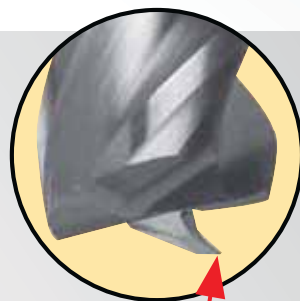

with micro-corner protection  
for longer tool life

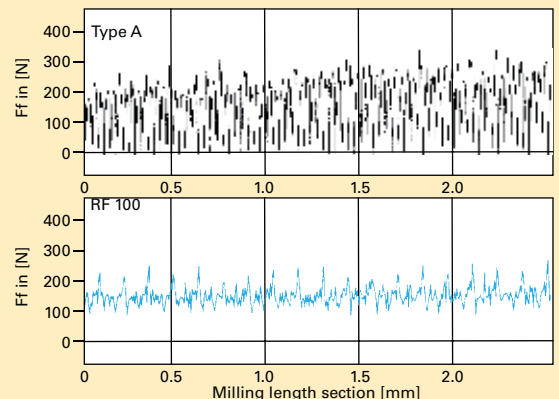

The cutting force comparison between a conventional milling cutter type N and the RF 100 shows a clearly quieter, more rigid operation of the RF 100.



# RF 100 A (4-Flute) - Inch - Standard Length



## center cutting



Standard



No. Flutes



Helix Angle



Rake Angle



Chamfer



Roughing



Finishing



HA



HB

Tool material

**Solid Carbide**

Surface finish

bright

Series

**3077**

Application group	Material examples	Ideal for
P	Steel	—
M	Stainless steel	—
K	Cast iron	—
N	Aluminum	●
S	Ni / Ti alloys	—
H	Hardened steel	—

●=Optimal ○=Secondary

Speed and Feed data found on page 290

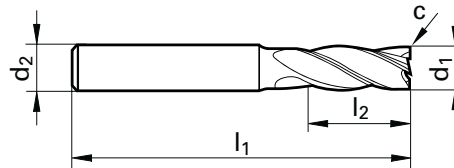

d1 h10	d2 h6	l1	l2	c	No. of Flutes	Code no.	EDP Number
inch	inch	inch	inch	inch x 45°			
3/16	3/16	2	5/8	0.004	4	4.760	<b>9030770047600</b>
1/4	1/4	2 1/2	3/4	0.006	4	6.350	<b>9030770063500</b>
5/16	5/16	2 1/2	13/16	0.006	4	7.940	<b>9030770079400</b>
3/8	3/8	2 1/2	1	0.008	4	9.520	<b>9030770095200</b>
1/2	1/2	3 1/2	1 1/4	0.010	4	12.700	<b>9030770127000</b>
5/8	5/8	3 1/2	1 1/4	0.014	4	15.870	<b>9030770158700</b>
3/4	3/4	4	1 1/2	0.018	4	19.050	<b>9030770190500</b>

# RF 100 A (4-Flute) - Metric - Standard Length



## center cutting



Standard



No. Flutes



Helix Angle



Chamfer



Rake Angle



Roughing



Finishing



HA



HB

Tool material

Solid Carbide

Surface finish

bright

Series

3202

3319

Application group	Material examples	Ideal for
P	Steel	—
M	Stainless steel	—
K	Cast iron	—
N	Aluminum	●
S	Ni / Ti alloys	—
H	Hardened steel	—

●=Optimal ○=Secondary

Speed and Feed data found on page 302

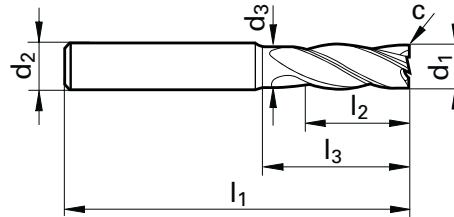

d1 h10	d2 h6	d3	l1	l2	l3	c	No. of Flutes	Code no.	EDP Number	
mm	mm	mm	mm	mm	mm	mm x 45°				
4.000	6.000	3.800	57.00	11.00	18.00	0.10	4	4.000	9032020040000	9033190040000
5.000	6.000	4.800	57.00	13.00	18.00	0.10	4	5.000	9032020050000	9033190050000
6.000	6.000	5.700	57.00	13.00	20.00	0.15	4	6.000	9032020060000	9033190060000
8.000	8.000	7.700	63.00	19.00	26.00	0.15	4	8.000	9032020080000	9033190080000
10.000	10.000	9.500	72.00	22.00	30.00	0.20	4	10.000	9032020100000	9033190100000
12.000	12.000	11.500	83.00	26.00	36.00	0.20	4	12.000	9032020120000	9033190120000
16.000	16.000	15.500	92.00	32.00	42.00	0.35	4	16.000	9032020160000	9033190160000
20.000	20.000	19.500	104.00	38.00	52.00	0.45	4	20.000	9032020200000	9033190200000

# RF 100 A (3-Flute) - Inch - Standard Length



## center cutting



Standard



No. Flutes



Helix Angle



Chamfer



Rake Angle



Slotting



Roughing



Ramping



Helix



Plunging



Finishing



HA



HB

Tool material

**Solid Carbide**

Surface finish

bright

Series

**4265**

Application group	Material examples	Ideal for
P	Steel	—
M	Stainless steel	—
K	Cast iron	—
N	Aluminum	●
S	Ni / Ti alloys	—
H	Hardened steel	—

●=Optimal ○=Secondary

Speed and Feed data found on page 290

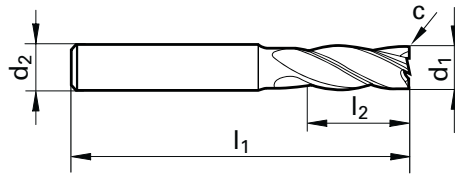

d1 h10	d2 h6	l1	l2	c	No. of Flutes	Code no.	EDP Number
inch	inch	inch	inch	inch x 45°			
1/8	1/8	2	1/2	0.001	3	3.170	9042650031700
3/16	3/16	2	5/8	0.002	3	4.760	9042650047600
1/4	1/4	2 1/2	3/4	0.002	3	6.350	9042650063500
5/16	5/16	2 1/2	13/16	0.003	3	7.940	9042650079400
3/8	3/8	2 1/2	1	0.004	3	9.520	9042650095200
7/16	7/16	2 3/4	1	0.004	3	11.110	9042650111100
1/2	1/2	3 1/2	1 1/4	0.005	3	12.700	9042650127000
5/8	5/8	3 1/2	1 1/4	0.006	3	15.870	9042650158700
3/4	3/4	4	1 1/2	0.007	3	19.050	9042650190500
1	1	4	1 1/2	0.010	3	25.400	9042650254000

# RF 100 A (3-Flute) - Metric - Standard Length



## center cutting

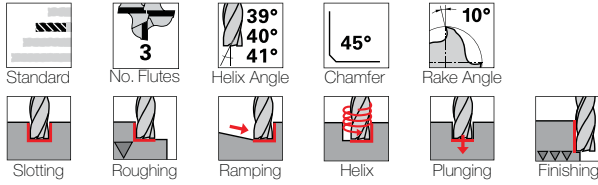

Tool material

**Solid Carbide**

Surface finish

bright

Series

**3472**

**6702**

Application group	Material examples	Ideal for
<b>P</b>	Steel	—
<b>M</b>	Stainless steel	—
<b>K</b>	Cast iron	—
<b>N</b>	Aluminum	●
<b>S</b>	Ni / Ti alloys	—
<b>H</b>	Hardened steel	—

●=Optimal ○=Secondary

Speed and Feed data found on page 302

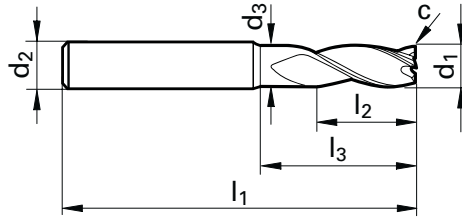

d1 e8	d2 h6	d3	l1	l2	l3	c	No. of Flutes	Code no.	EDP Number	
mm	mm	mm	mm	mm	mm	mm x 45°				
3.000	6.000	2.800	57.00	8.00	15.00	0.03	3	3.000	9034720030000	9067020030000
4.000	6.000	3.800	57.00	11.00	18.00	0.04	3	4.000	9034720040000	9067020040000
5.000	6.000	4.800	57.00	13.00	18.00	0.05	3	5.000	9034720050000	9067020050000
6.000	6.000	5.700	57.00	13.00	20.00	0.06	3	6.000	9034720060000	9067020060000
8.000	8.000	7.700	63.00	19.00	26.00	0.08	3	8.000	9034720080000	9067020080000
10.000	10.000	9.500	72.00	22.00	30.00	0.10	3	10.000	9034720100000	9067020100000
12.000	12.000	11.500	83.00	26.00	36.00	0.12	3	12.000	9034720120000	9067020120000
16.000	16.000	15.500	92.00	32.00	42.00	0.16	3	16.000	9034720160000	9067020160000
20.000	20.000	19.500	104.00	38.00	52.00	0.20	3	20.000	9034720200000	9067020200000

# RF 100 A (3-Flute) - Metric - Standard Length



## center cutting with corner radius

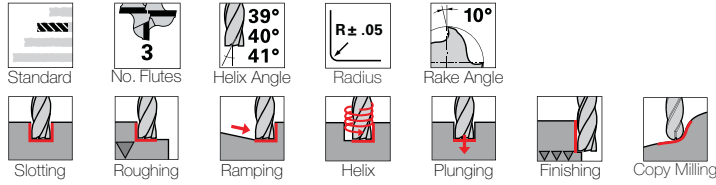

Tool material

**Solid Carbide**

Surface finish

bright

Series

**6729**

Application group	Material examples	Ideal for
<b>P</b>	Steel	—
<b>M</b>	Stainless steel	—
<b>K</b>	Cast iron	—
<b>N</b>	Aluminum	●
<b>S</b>	Ni / Ti alloys	—
<b>H</b>	Hardened steel	—

●=Optimal ○=Secondary

Speed and Feed data found on page 302

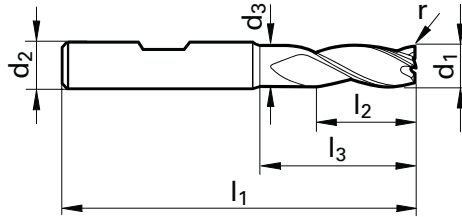

d1 e8	d2 h6	d3	l1	l2	l3	r	No. of Flutes	Code no.	EDP Number
mm	mm	mm	mm	mm	mm	mm x 45°			
6.000	6.000	5.700	57.00	13.00	20.00	0.50	3	6.0050	9067290060050
6.000	6.000	5.700	57.00	13.00	20.00	1.00	3	6.0100	9067290060100
8.000	8.000	7.700	63.00	19.00	26.00	0.50	3	8.0050	9067290080050
8.000	8.000	7.700	63.00	19.00	26.00	1.00	3	8.0100	9067290080100
10.000	10.000	9.500	72.00	22.00	30.00	0.50	3	10.005	9067290100050
10.000	10.000	9.500	72.00	22.00	30.00	1.00	3	10.010	9067290100100
10.000	10.000	9.500	72.00	22.00	30.00	1.50	3	10.015	9067290100150
12.000	12.000	11.500	83.00	26.00	36.00	0.50	3	12.005	9067290120050
12.000	12.000	11.500	83.00	26.00	36.00	1.00	3	12.010	9067290120100
12.000	12.000	11.500	83.00	26.00	36.00	1.50	3	12.015	9067290120150
12.000	12.000	11.500	83.00	26.00	36.00	2.00	3	12.020	9067290120200
12.000	12.000	11.500	83.00	26.00	36.00	2.50	3	12.025	9067290120250
12.000	12.000	11.500	83.00	26.00	36.00	3.00	3	12.030	9067290120300
12.000	12.000	11.500	83.00	26.00	36.00	4.00	3	12.040	9067290120400
16.000	16.000	15.500	92.00	32.00	42.00	1.00	3	16.010	9067290160100
16.000	16.000	15.500	92.00	32.00	42.00	2.00	3	16.020	9067290160200
16.000	16.000	15.500	92.00	32.00	42.00	2.50	3	16.025	9067290160250
16.000	16.000	15.500	92.00	32.00	42.00	3.00	3	16.030	9067290160300
16.000	16.000	15.500	92.00	32.00	42.00	4.00	3	16.040	9067290160400
20.000	20.000	19.500	104.00	38.00	52.00	1.00	3	20.010	9067290200100
20.000	20.000	19.500	104.00	38.00	52.00	2.00	3	20.020	9067290200200
20.000	20.000	19.500	104.00	38.00	52.00	2.50	3	20.025	9067290200250
20.000	20.000	19.500	104.00	38.00	52.00	3.00	3	20.030	9067290200300
20.000	20.000	19.500	104.00	38.00	52.00	4.00	3	20.040	9067290200400
25.000	25.000	24.000	121.00	45.00	63.00	2.00	3	25.020	9067290250200
25.000	25.000	24.000	121.00	45.00	63.00	3.00	3	25.030	9067290250300
25.000	25.000	24.000	121.00	45.00	63.00	4.00	3	25.040	9067290250400

# RF 100 A (3-Flute) - Metric - Long Length



## center cutting

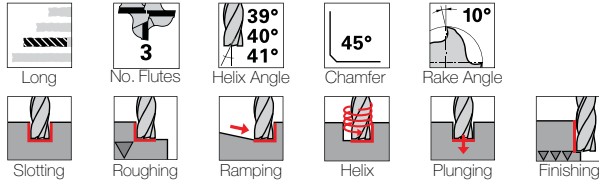

Tool material

**Solid Carbide**

Surface finish

bright

Series

**3473**

**6703**

Application group	Material examples	Ideal for
P	Steel	—
M	Stainless steel	—
K	Cast iron	—
N	Aluminum	●
S	Ni / Ti alloys	—
H	Hardened steel	—

●=Optimal ○=Secondary

Speed and Feed data found on page 302

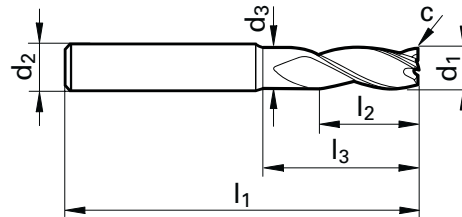

d1 e8	d2 h6	d3	l1	l2	l3	c	No. of Flutes	Code no.	EDP Number	
mm	mm	mm	mm	mm	mm	mm x 45°				
6.000	6.000	5.700	65.00	13.00	28.00	0.06	3	6.000	9034730060000	9067030060000
8.000	8.000	7.700	75.00	19.00	38.00	0.08	3	8.000	9034730080000	9067030080000
10.000	10.000	9.500	80.00	22.00	38.00	0.10	3	10.000	9034730100000	9067030100000
12.000	12.000	11.500	93.00	26.00	46.00	0.12	3	12.000	9034730120000	9067030120000
16.000	16.000	15.500	108.00	32.00	58.00	0.16	3	16.000	9034730160000	9067030160000
20.000	20.000	19.500	126.00	38.00	74.00	0.20	3	20.000	9034730200000	9067030200000

# RF 100 A (3-Flute) - Metric - XL Long Length (3xD)



## center cutting

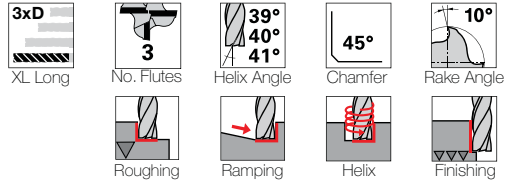

Tool material

**Solid Carbide**

Surface finish

bright

Series

**6730**

**6731**

Application group	Material examples	Ideal for
P	Steel	—
M	Stainless steel	—
K	Cast iron	—
N	Aluminum	●
S	Ni / Ti alloys	—
H	Hardened steel	—

●=Optimal ○=Secondary

Speed and Feed data found on page 302

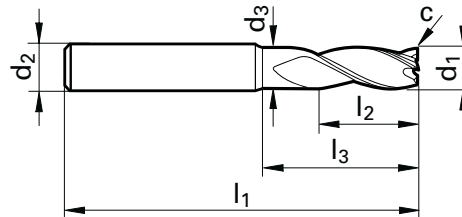

d1 e8	d2 h6	d3	l1	l2	l3	c	No. of Flutes	Code no.	EDP Number	
mm	mm	mm	mm	mm	mm	mm x 45°				
5.000	6.000	4.800	57.00	15.00	19.40	0.05	3	5.000	9067300050000	9067310050000
6.000	6.000	5.700	65.00	18.00	28.00	0.06	3	6.000	9067300060000	9067310060000
8.000	8.000	7.700	75.00	24.00	38.00	0.08	3	8.000	9067300080000	9067310080000
10.000	10.000	9.500	80.00	30.00	38.00	0.10	3	10.000	9067300100000	9067310100000
12.000	12.000	11.500	93.00	36.00	46.00	0.12	3	12.000	9067300120000	9067310120000
16.000	16.000	15.500	108.00	48.00	58.00	0.16	3	16.000	9067300160000	9067310160000
20.000	20.000	19.500	126.00	60.00	74.00	0.20	3	20.000	9067300200000	9067310200000

# RF 100 A (3-Flute) - Metric - XL Long Length (4xD)



## center cutting

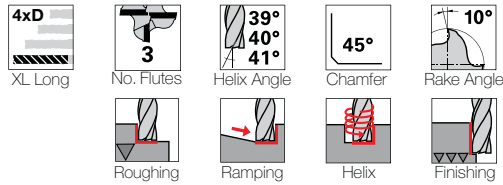

Tool material

**Solid Carbide**

Surface finish

bright

Series

**6732**

**6733**

Application group	Material examples	Ideal for
P	Steel	—
M	Stainless steel	—
K	Cast iron	—
N	Aluminum	●
S	Ni / Ti alloys	—
H	Hardened steel	—

●=Optimal ○=Secondary

Speed and Feed data found on page 302

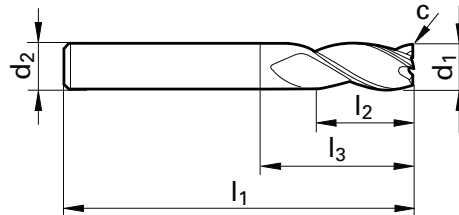

d1 e8	d2 h6	l1	l2	l3	c	No. of Flutes	Code no.	EDP Number	
mm	mm	mm	mm	mm	mm x 45°				
6.000	6.000	65.00	24.00	29.00	0.06	3	6.000	9067320060000	9067330060000
8.000	8.000	75.00	32.00	39.00	0.08	3	8.000	9067320080000	9067330080000
10.000	10.000	100.00	40.00	60.00	0.10	3	10.000	9067320100000	9067330100000
12.000	12.000	100.00	48.00	55.00	0.12	3	12.000	9067320120000	9067330120000
16.000	16.000	125.00	64.00	77.00	0.16	3	16.000	9067320160000	9067330160000
20.000	20.000	150.00	80.00	100.00	0.20	3	20.000	9067320200000	9067330200000



# RF 100 A (3-Flute) - Metric - XL Long Length (5xD)



## center cutting



XL Long



No. Flutes



Helix Angle



Chamfer



Rake Angle



Roughing



Ramping



Helix



Finishing



HA



HB

Tool material

**Solid Carbide**

Surface finish

bright

Series

**6734**

**6735**

Application group	Material examples	Ideal for
P	Steel	—
M	Stainless steel	—
K	Cast iron	—
N	Aluminum	●
S	Ni / Ti alloys	—
H	Hardened steel	—

●=Optimal ○=Secondary

Speed and Feed data found on page 302

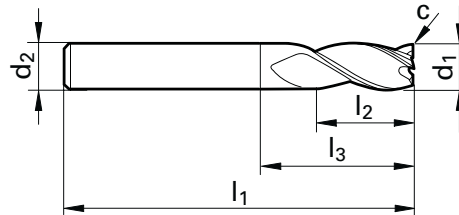

d1 e8	d2 h6	l1	l2	l3	c	No. of Flutes	Code no.	EDP Number	
mm	mm	mm	mm	mm	mm x 45°				
6.000	6.000	75.00	30.00	39.00	0.06	3	6.000	9067340060000	9067350060000
8.000	8.000	86.00	40.00	50.00	0.08	3	8.000	9067340080000	9067350080000
10.000	10.000	100.00	50.00	60.00	0.10	3	10.000	9067340100000	9067350100000
12.000	12.000	120.00	60.00	75.00	0.12	3	12.000	9067340120000	9067350120000
16.000	16.000	150.00	80.00	102.00	0.16	3	16.000	9067340160000	9067350160000
20.000	20.000	175.00	100.00	125.00	0.20	3	20.000	9067340200000	9067350200000

# RF 100 A/WF

## High-performance roughing end mills for aluminium and Al-alloys

Based on our RF 100 end mill with unequal helix angles in combination with a newly developed roughing geometry. The result is a dramatic increase in tool life in comparison to conventional rough milling cutters with round or flat knuckle-type teeth. At the same time, the surface quality of the workpiece is improved to a peak-to-valley height of appr.  $R_a = 2-3 \mu\text{m}$ , making in many cases finishing operations unnecessary.

Simultaneously, the innovative design reduces power consumption in comparison to conventional RF 100 end mills allowing the application in unstable conditions and on less powerful machines

### Summary of advantages

- Low cutting pressure and power consumption
- Vibration-free operation
- Increased feed rates possible
- Increased surface qualities ( $R_a = 2-3 \mu\text{m}$ )
- Longer tool life

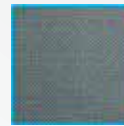
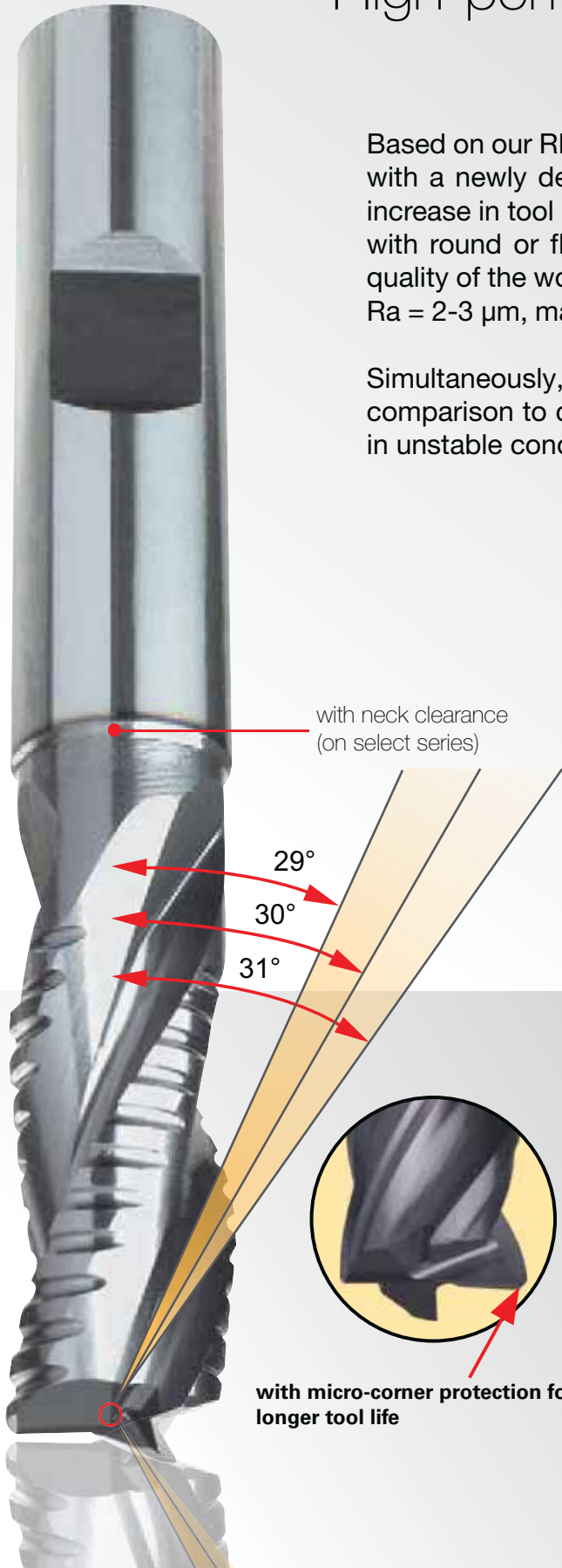

Workpiece surface  
 $R_a = 2-3 \mu\text{m}$

Type	Roughing end mill	RF 100 A/WF
Performance index	100%	140%
Workpiece surface	$R_a = 9-10 \mu\text{m}$ 	$R_a = 2-3 \mu\text{m}$ 
Tool life index	100%	180%
Power consumption	100%	130%
Cutting pressure	100%	125%

# RF 100 A/WF (3-Flute) - Inch - Standard Length



## center cutting



Standard



No. Flutes



Helix angle



Chamfer



Rake Angle



Slotting



Roughing



Ramping



Helix



HA



HB

Tool material

**Solid Carbide**

Surface finish

bright

Series

**4266**

Application group	Material examples	Ideal for
P	Steel	—
M	Stainless steel	—
K	Cast iron	—
N	Aluminum	●
S	Ni / Ti alloys	—
H	Hardened steel	—

●=Optimal ○=Secondary

Speed and Feed data found on page 291

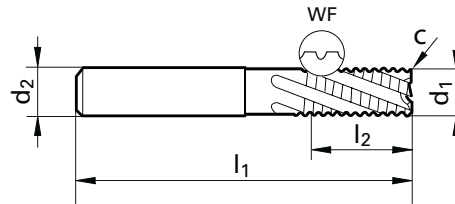

d1 h10	d2 h6	l1	l2	c	No. of Flutes	Code no.	EDP Number
inch	inch	inch	inch	inch x 45°			
1/4	1/4	2 1/2	3/4	0.012	3	6.350	9042660063500
5/16	5/16	2 1/2	13/16	0.012	3	7.940	9042660079400
3/8	3/8	2 1/2	1	0.012	3	9.520	9042660095200
1/2	1/2	3 1/2	1 1/4	0.020	3	12.700	9042660127000
5/8	5/8	3 1/2	1 1/4	0.020	3	15.870	9042660158700
3/4	3/4	4	1 1/2	0.020	3	19.050	9042660190500
1	1	4	1 1/2	0.031	3	25.400	9042660254000

# RF 100 A/WF - Metric - Standard Length



## center cutting

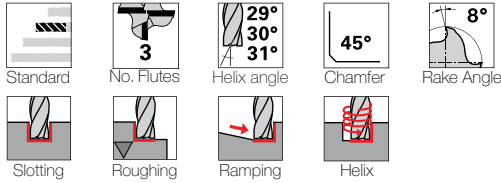

Tool material

**Solid Carbide**

Surface finish

bright

Series

**3468**

**3469**

Application group	Material examples	Ideal for
P	Steel	—
M	Stainless steel	—
K	Cast iron	—
N	Aluminum	●
S	Ni / Ti alloys	—
H	Hardened steel	—

●=Optimal ○=Secondary

Speed and Feed data found on page 303

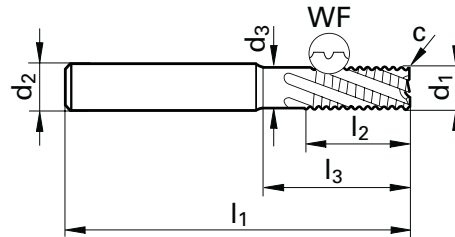

d1 h10	d2 h6	d3	l1	l2	l3	c	No. of Flutes	Code no.	EDP Number	
mm	mm	mm	mm	mm	mm	mm x 45°				
6.000	6.000	5.700	57.00	13.00	20.00	0.30	3	6.000	9034680060000	9034690060000
8.000	8.000	7.700	63.00	19.00	26.00	0.30	3	8.000	9034680080000	9034690080000
10.000	10.000	9.500	72.00	22.00	30.00	0.30	3	10.000	9034680100000	9034690100000
12.000	12.000	11.500	83.00	26.00	36.00	0.50	3	12.000	9034680120000	9034690120000
16.000	16.000	15.500	92.00	32.00	42.00	0.50	3	16.000	9034680160000	9034690160000
20.000	20.000	19.500	104.00	38.00	52.00	0.50	3	20.000	9034680200000	9034690200000
25.000	25.000	24.000	121.00	45.00	63.00	0.60	3	25.000	9034680250000	9034690250000

# RF 100 A/WF - Metric - Long Length



## center cutting

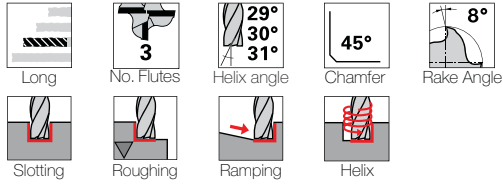

Tool material

**Solid Carbide**

Surface finish

bright

Series

**3470**

**3471**

Application group	Material examples	Ideal for
P	Steel	—
M	Stainless steel	—
K	Cast iron	—
N	Aluminum	●
S	Ni / Ti alloys	—
H	Hardened steel	—

●=Optimal ○=Secondary

Speed and Feed data found on page 303

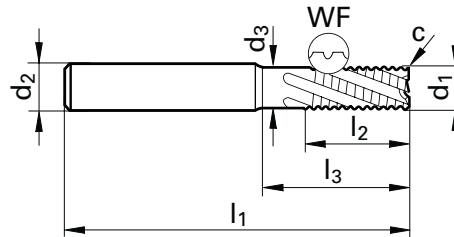

d1 h10	d2 h6	d3	l1	l2	l3	c	No. of Flutes	Code no.	EDP Number	
mm	mm	mm	mm	mm	mm	mm x 45°				
6.000	6.000	5.700	65.00	13.00	28.00	0.30	3	6.000	9034700060000	9034710060000
8.000	8.000	7.700	75.00	19.00	38.00	0.30	3	8.000	9034700080000	9034710080000
10.000	10.000	9.500	80.00	22.00	38.00	0.30	3	10.000	9034700100000	9034710100000
12.000	12.000	11.500	93.00	26.00	46.00	0.50	3	12.000	9034700120000	9034710120000
16.000	16.000	15.500	108.00	32.00	58.00	0.50	3	16.000	9034700160000	9034710160000
20.000	20.000	19.500	126.00	38.00	74.00	0.50	3	20.000	9034700200000	9034710200000

# RF 100 H

High-performance end mills  
for hardened steels  
above 63 HRC

Roughing and finishing of hardened steels,  
tool steels and chilled cast iron

Flute design with reinforced core for  
roughing

up to  $a_p$ : 1xD (from 32 to 54 HRC)

Finishing and HPC milling over entire cutting  
edge length also above 63 HRC

Longer tool life  
thanks to improved  
nano-Si<sup>®</sup> coating

RF 100 H • Guhring series 3895



face cutting edges with  
center cutting



micro-corner protection  
for longer tool life

# RF 100 H - Metric - Standard Length



## center cutting



Standard



No. Flutes  
4



Helix Angle  
40°  
42°



Chamfer  
45°



Rake Angle  
-15°



Roughing



Finishing



HA



HB

Tool material

Solid Carbide

Surface finish

nano-Si®

Series

3895

3896

Application group	Material examples	Ideal for
P	Steel	●
M	Stainless steel	—
K	Cast iron	—
N	Aluminum	—
S	Ni / Ti alloys	—
H	Hardened steel	●

●=Optimal ○=Secondary

Speed and Feed data found on page 302

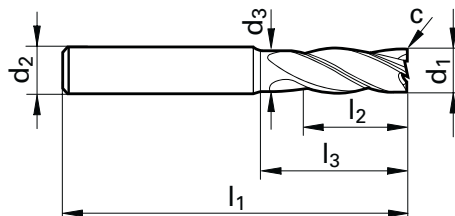

d1 h10	d2 h6	d3	l1	l2	l3	c	No. of Flutes	Code no.	EDP Number	
mm	mm	mm	mm	mm	mm	mm x 45°				
6.000	6.000	5.700	57.00	13.00	20.00	0.15	4	6.000	9038950060000	9038960060000
8.000	8.000	7.700	63.00	19.00	26.00	0.15	4	8.000	9038950080000	9038960080000
10.000	10.000	9.500	72.00	22.00	30.00	0.20	4	10.000	9038950100000	9038960100000
12.000	12.000	11.500	83.00	26.00	36.00	0.20	4	12.000	9038950120000	9038960120000
16.000	16.000	15.500	92.00	32.00	42.00	0.35	4	16.000	9038950160000	9038960160000
20.000	20.000	19.500	104.00	38.00	52.00	0.45	4	20.000	9038950200000	9038960200000

# RF 100 Ti

## High-performance roughing end mills for special and Ti-alloys

RF 100 high-performance end mills excel thanks to variable helix angles which considerably reduce vibration. The uneven helix angle vastly improves surface quality for finishing operations and a considerably higher feed rate for slot drilling and roughing operations are also achieved.

With many applications, the complete milling process can be covered with one RF 100, which as well as increasing tool life and dimensional accuracy of the workpiece generates a considerable cost advantage.

Suitable for roughing and finishing. Up to 60% higher feed rates and up to 4-times longer tool life.

Vibration-free operation and improved workpiece surface quality.

RF 100 Ti · Guhring series 3498



High wear protection through constant rake angle in radius area



Seamless radius area for high form and contour accuracy



# RF 100 Ti (4-flute) - Inch - Standard Length

A

## center cutting with corner radius

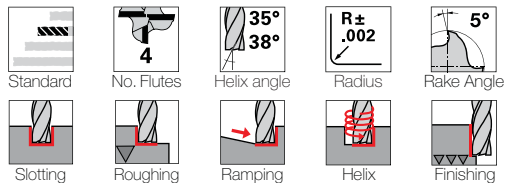

Tool material

Solid Carbide

Surface finish

Super-A™

Series

3876

Application group	Material examples	Ideal for
P	Steel	●
M	Stainless steel	○
K	Cast iron	●
N	Aluminum	—
S	Ni / Ti alloys	●
H	Hardened steel	—

●=Optimal    ○=Secondary

Speed and Feed data found on page 290

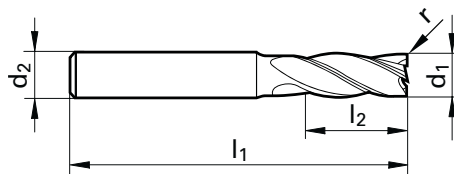

d1 h10	d2 h6	l1	l2	radius	No. of Flutes	Code no.	EDP Number
inch	inch	inch	inch	inch			
1/4	1/4	2 1/2	3/4	0.015	4	6.352	9038760063520
1/4	1/4	2 1/2	3/4	0.031	4	6.354	9038760063540
5/16	5/16	2 1/2	13/16	0.031	4	7.944	9038760079440
3/8	3/8	2 1/2	1	0.031	4	9.524	9038760095240
7/16	7/16	2 3/4	1	0.031	4	11.114	9038760111140
1/2	1/2	3 1/2	1 1/4	0.031	4	12.704	9038760127040
1/2	1/2	3 1/2	1 1/4	0.040	4	12.705	9038760127050
1/2	1/2	3 1/2	1 1/4	0.062	4	12.706	9038760127060
1/2	1/2	3 1/2	1 1/4	0.090	4	12.707	9038760127070
5/8	5/8	3 1/2	1 1/4	0.031	4	15.874	9038760158740
5/8	5/8	3 1/2	1 1/4	0.062	4	15.876	9038760158760
3/4	3/4	4	1 1/2	0.062	4	19.056	9038760190560
3/4	3/4	4	1 1/2	0.090	4	19.057	9038760190570
3/4	3/4	4	1 1/2	0.125	4	19.059	9038760190590
1	1	4	1 1/2	0.062	4	25.406	9038760254060
1	1	4	1 1/2	0.090	4	25.407	9038760254070
1	1	4	1 1/2	0.125	4	25.409	9038760254090

# RF 100 Ti (4-flute) - Metric - Standard Length



## center cutting with corner radius

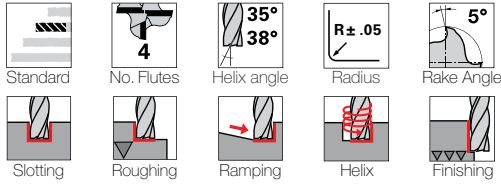

Tool material

Solid Carbide

Surface finish

Super-A™

Series

3498

3499

Application group	Material examples	Ideal for
P	Steel	●
M	Stainless steel	○
K	Cast iron	●
N	Aluminum	—
S	Ni / Ti alloys	●
H	Hardened steel	—

●=Optimal ○=Secondary

Speed and Feed data found on page 302

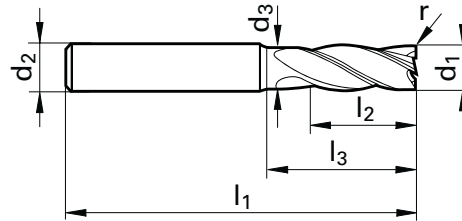

d1 h10	d2 h6	d3	l1	l2	l3	r	No. of Flutes	Code no.	EDP Number	
mm	mm	mm	mm	mm	mm	mm				
6.000	6.000	5.700	57.00	13.00	20.00	0.50	4	6.005	9034980060050	9034990060050
6.000	6.000	5.700	57.00	13.00	20.00	0.80	4	6.008	9034980060080	9034990060080
6.000	6.000	5.700	57.00	13.00	20.00	1.00	4	6.010	9034980060100	9034990060100
6.000	6.000	5.700	57.00	13.00	20.00	1.50	4	6.015	9034980060150	9034990060150
6.000	6.000	5.700	57.00	13.00	20.00	2.00	4	6.020	9034980060200	9034990060200
8.000	8.000	7.700	63.00	19.00	26.00	0.50	4	8.005	9034980080050	9034990080050
8.000	8.000	7.700	63.00	19.00	26.00	0.80	4	8.008	9034980080080	9034990080080
8.000	8.000	7.700	63.00	19.00	26.00	1.00	4	8.010	9034980080100	9034990080100
8.000	8.000	7.700	63.00	19.00	26.00	1.50	4	8.015	9034980080150	9034990080150
8.000	8.000	7.700	63.00	19.00	26.00	2.00	4	8.020	9034980080200	9034990080200
10.000	10.000	9.500	72.00	22.00	30.00	0.50	4	10.005	9034980100050	9034990100050
10.000	10.000	9.500	72.00	22.00	30.00	0.80	4	10.008	9034980100080	9034990100080
10.000	10.000	9.500	72.00	22.00	30.00	1.00	4	10.010	9034980100100	9034990100100
10.000	10.000	9.500	72.00	22.00	30.00	1.50	4	10.015	9034980100150	9034990100150
10.000	10.000	9.500	72.00	22.00	30.00	2.00	4	10.020	9034980100200	9034990100200
12.000	12.000	11.500	83.00	26.00	36.00	0.50	4	12.005	9034980120050	9034990120050
12.000	12.000	11.500	83.00	26.00	36.00	0.80	4	12.008	9034980120080	9034990120080
12.000	12.000	11.500	83.00	26.00	36.00	1.00	4	12.010	9034980120100	9034990120100
12.000	12.000	11.500	83.00	26.00	36.00	1.50	4	12.015	9034980120150	9034990120150
12.000	12.000	11.500	83.00	26.00	36.00	2.00	4	12.020	9034980120200	9034990120200
12.000	12.000	11.500	83.00	26.00	36.00	2.50	4	12.025	9034980120250	9034990120250
12.000	12.000	11.500	83.00	26.00	36.00	3.00	4	12.030	9034980120300	9034990120300
12.000	12.000	11.500	83.00	26.00	36.00	3.175	4	12.031	9034980120310	9034990120310
12.000	12.000	11.500	83.00	26.00	36.00	4.00	4	12.040	9034980120400	9034990120400

Continued on next page

# RF 100 Ti (4-flute) - Metric - Standard Length



## center cutting with corner radius

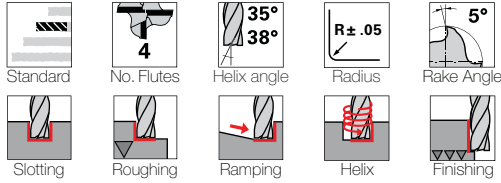

Tool material

Solid Carbide

Surface finish

Super-A™

Series

3498

3499

Application group	Material examples	Ideal for
P	Steel	●
M	Stainless steel	○
K	Cast iron	●
N	Aluminum	—
S	Ni / Ti alloys	●
H	Hardened steel	—

●=Optimal ○=Secondary

Speed and Feed data found on page 302

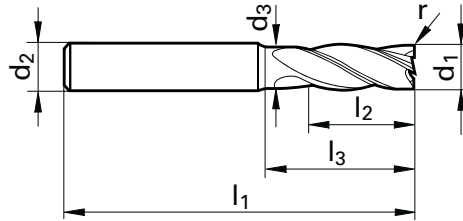

Continued from previous page

d1 h10	d2 h6	d3	l1	l2	l3	r	No. of Flutes	Code no.	EDP Number	
mm	mm	mm	mm	mm	mm	mm				
16.000	16.000	15.500	92.00	32.00	42.00	0.50	4	16.005	9034980160050	9034990160050
16.000	16.000	15.500	92.00	32.00	42.00	0.80	4	16.008	9034980160080	9034990160080
16.000	16.000	15.500	92.00	32.00	42.00	1.00	4	16.010	9034980160100	9034990160100
16.000	16.000	15.500	92.00	32.00	42.00	1.50	4	16.015	9034980160150	9034990160150
16.000	16.000	15.500	92.00	32.00	42.00	2.00	4	16.020	9034980160200	9034990160200
16.000	16.000	15.500	92.00	32.00	42.00	2.50	4	16.025	9034980160250	9034990160250
16.000	16.000	15.500	92.00	32.00	42.00	3.00	4	16.030	9034980160300	9034990160300
16.000	16.000	15.500	92.00	32.00	42.00	3.175	4	16.031	9034980160310	9034990160310
16.000	16.000	15.500	92.00	32.00	42.00	4.00	4	16.040	9034980160400	9034990160400
20.000	20.000	19.500	104.00	38.00	52.00	0.50	4	20.005	9034980200050	9034990200050
20.000	20.000	19.500	104.00	38.00	52.00	1.00	4	20.010	9034980200100	9034990200100
20.000	20.000	19.500	104.00	38.00	52.00	1.50	4	20.015	9034980200150	9034990200150
20.000	20.000	19.500	104.00	38.00	52.00	2.00	4	20.020	9034980200200	9034990200200
20.000	20.000	19.500	104.00	38.00	52.00	2.50	4	20.025	9034980200250	9034990200250
20.000	20.000	19.500	104.00	38.00	52.00	3.00	4	20.030	9034980200300	9034990200300
20.000	20.000	19.500	104.00	38.00	52.00	3.175	4	20.031	9034980200310	9034990200310
20.000	20.000	19.500	104.00	38.00	52.00	4.00	4	20.040	9034980200400	9034990200400
25.000	25.000	24.000	121.00	45.00	63.00	1.50	4	25.015	9034980250150	9034990250150
25.000	25.000	24.000	121.00	45.00	63.00	2.00	4	25.020	9034980250200	9034990250200
25.000	25.000	24.000	121.00	45.00	63.00	2.50	4	25.025	9034980250250	9034990250250
25.000	25.000	24.000	121.00	45.00	63.00	3.00	4	25.030	9034980250300	9034990250300
25.000	25.000	24.000	121.00	45.00	63.00	3.175	4	25.031	9034980250310	9034990250310
25.000	25.000	24.000	121.00	45.00	63.00	4.00	4	25.040	9034980250400	9034990250400
25.000	25.000	24.000	121.00	45.00	63.00	5.00	4	25.050	9034980250500	9034990250500

# RF 100 S/F

High-performance finishing end mills  
for materials up to  
1600 N/mm<sup>2</sup> (48 HRC)



RF 100 SF · Guhring series 3631

**P M K N S H**

The suitable solution for multiple materials: Steel, cast iron, stainless materials, titanium- and special alloys and aluminum

Available in 5 or 6-flute, for semi-roughing with  $a_e$  up to  $0.3x D$  over entire cutting edge length, optimal surface finish with fine finishing or HSC operations, universal for materials up to 1600 Nm<sup>2</sup> (48 HRC)



Face cutting edges with center cutting



Micro-corner protection for longer tool life

# RF 100 S/F (5-flute) - Inch - Standard Length



## center cutting

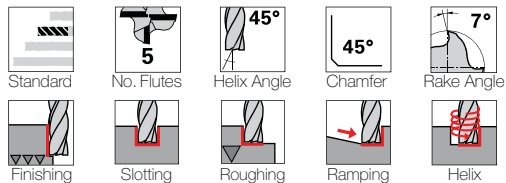

Tool material

**Solid Carbide**

Surface finish

FIREX®

Series

**4263**

Application group	Material examples	Ideal for
P	Steel	●
M	Stainless steel	●
K	Cast iron	●
N	Aluminum	○
S	Ni / Ti alloys	●
H	Hardened steel	○

●=Optimal    ○=Secondary

Speed and Feed data found on page 290

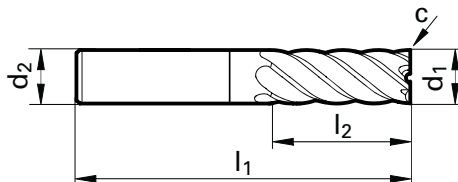

d1 h10	d2 h6	l1	l2	c	No. of Flutes	Code no.	EDP Number
inch	inch	inch	inch	inch x 45°			
3/16	3/16	2	5/8	0.002	5	4.760	9042630047600
1/4	1/4	2 1/2	3/4	0.004	5	6.350	9042630063500
5/16	5/16	2 1/2	13/16	0.004	5	7.940	9042630079400
3/8	3/8	2 1/2	1	0.004	5	9.520	9042630095200
7/16	7/16	2 3/4	1	0.006	5	11.110	9042630111100
1/2	1/2	3 1/2	1 1/4	0.006	5	12.700	9042630127000
5/8	5/8	3 1/2	1 1/4	0.006	5	15.870	9042630158700
3/4	3/4	4	1 1/2	0.006	5	19.050	9042630190500
1	1	4	1 1/2	0.012	5	25.400	9042630254000
1 1/4	1 1/4	6	2 1/2	0.012	5	31.750	9042630317500

# RF 100 S/F (5-flute) - Metric - Standard Length



## center cutting

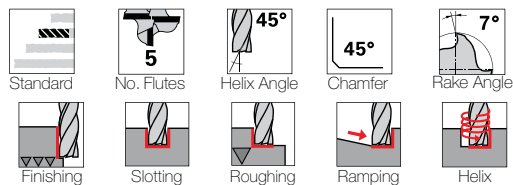

Tool material

**Solid Carbide**

Surface finish

**FIREX®**

Series

**6709**

**6710**

Application group	Material examples	Ideal for
<b>P</b>	Steel	●
<b>M</b>	Stainless steel	●
<b>K</b>	Cast iron	●
<b>N</b>	Aluminum	○
<b>S</b>	Ni / Ti alloys	●
<b>H</b>	Hardened steel	○

●=Optimal    ○=Secondary

Speed and Feed data found on page 302

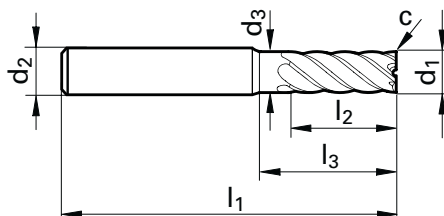

d1 h10	d2 h6	d3	l1	l2	l3	c	No. of Flutes	Code no.	EDP Number	
mm	mm	mm	mm	mm	mm	mm x 45°				
4.000	6.000	3.800	57.00	11.00	18.00	0.05	5	4.000	9067090040000	9067100040000
5.000	6.000	4.800	57.00	13.00	18.00	0.05	5	5.000	9067090050000	9067100050000
6.000	6.000	5.700	57.00	13.00	20.00	0.05	5	6.000	9067090060000	9067100060000
8.000	8.000	7.700	63.00	19.00	26.00	0.10	5	8.000	9067090080000	9067100080000
10.000	10.000	9.500	72.00	22.00	30.00	0.10	5	10.000	9067090100000	9067100100000
12.000	12.000	11.500	83.00	26.00	36.00	0.10	5	12.000	9067090120000	9067100120000
16.000	16.000	15.500	92.00	32.00	42.00	0.15	5	16.000	9067090160000	9067100160000
20.000	20.000	19.500	104.00	38.00	52.00	0.15	5	20.000	9067090200000	9067100200000
25.000	25.000	24.000	121.00	45.00	63.00	0.20	5	25.000	9067090250000	9067100250000

# RF 100 S/F (5-flute) - Inch - Long Length



## center cutting

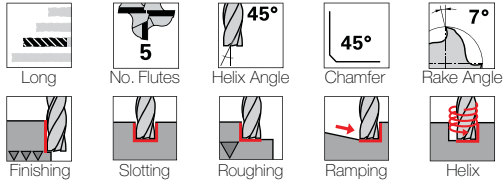

Tool material

**Solid Carbide**

Surface finish

FIREX®

Series

**4264**

Application group	Material examples	Ideal for
P	Steel	●
M	Stainless steel	●
K	Cast iron	●
N	Aluminum	○
S	Ni / Ti alloys	●
H	Hardened steel	○

●=Optimal    ○=Secondary

Speed and Feed data found on page 290

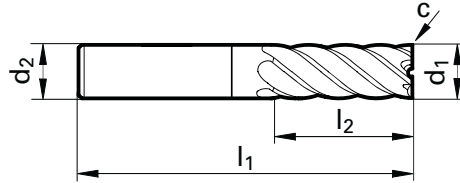

d1 h10	d2 h6	l1	l2	c	No. of Flutes	Code no.	EDP Number
inch	inch	inch	inch	inch x 45°			
3/16	3/16	2 1/2	3/4	0.002	5	4.760	9042640047600
1/4	1/4	3 1/4	1 1/4	0.004	5	6.350	9042640063500
5/16	5/16	3 1/4	1 1/2	0.004	5	7.940	9042640079400
3/8	3/8	4	1 3/4	0.004	5	9.520	9042640095200
7/16	7/16	4 1/2	2	0.006	5	11.110	9042640111100
1/2	1/2	4 1/2	2	0.006	5	12.700	9042640127000
5/8	5/8	5	2 1/4	0.006	5	15.870	9042640158700
3/4	3/4	5	2 1/4	0.006	5	19.050	9042640190500
1	1	5	2 1/4	0.012	5	25.400	9042640254000
1 1/4	1 1/4	7 1/2	4	0.012	5	31.750	9042640317500

# RF 100 S/F (5-flute) - Metric - XL Long Length (3xD)



## center cutting

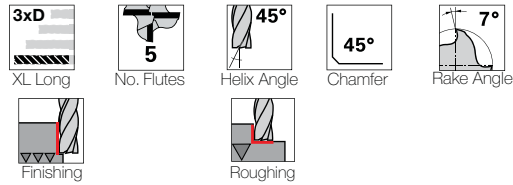

Tool material

**Solid Carbide**

Surface finish

FIREX®

Series

**3897**

**3898**

Application group	Material examples	Ideal for
<b>P</b>	Steel	●
<b>M</b>	Stainless steel	●
<b>K</b>	Cast iron	●
<b>N</b>	Aluminum	○
<b>S</b>	Ni / Ti alloys	●
<b>H</b>	Hardened steel	○

●=Optimal    ○=Secondary

Speed and Feed data found on page 302

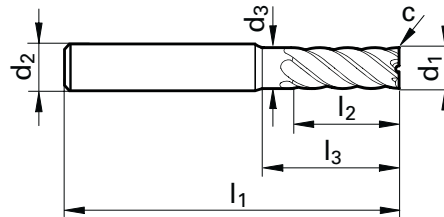

d1 h10	d2 h6	d3	l1	l2	l3	c	No. of Flutes	Code no.	EDP Number	
mm	mm	mm	mm	mm	mm	mm x 45°				
4.000	6.000	3.800	65.00	12.00	26.00	0.05	5	4.000	9038970040000	9038980040000
5.000	6.000	4.800	65.00	15.00	26.00	0.05	5	5.000	9038970050000	9038980050000
6.000	6.000	5.700	65.00	18.00	28.00	0.05	5	6.000	9038970060000	9038980060000
8.000	8.000	7.700	75.00	24.00	38.00	0.10	5	8.000	9038970080000	9038980080000
10.000	10.000	9.500	80.00	30.00	38.00	0.10	5	10.000	9038970100000	9038980100000
12.000	12.000	11.500	93.00	36.00	46.00	0.10	5	12.000	9038970120000	9038980120000
16.000	16.000	15.500	108.00	48.00	58.00	0.15	5	16.000	9038970160000	9038980160000
20.000	20.000	19.500	126.00	60.00	74.00	0.15	5	20.000	9038970200000	9038980200000



# RF 100 S/F (6-flute) - Inch - Standard Length



## center cutting



Standard



No. Flutes



Helix angle



Chamfer



Rake Angle



Finishing



Tool material

**Solid Carbide**

Surface finish

FIREX®

Series

**3115**

Application group	Material examples	Ideal for
<b>P</b>	Steel	●
<b>M</b>	Stainless steel	●
<b>K</b>	Cast iron	●
<b>N</b>	Aluminum	○
<b>S</b>	Ni / Ti alloys	●
<b>H</b>	Hardened steel	○

●=Optimal    ○=Secondary

Speed and Feed data found on page 290

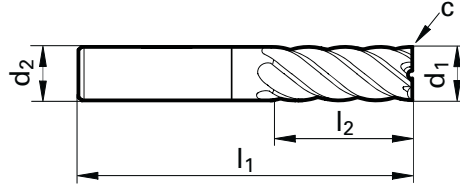

d1 h10	d2 h6	l1	l2	c	No. of Flutes	Code no.	EDP Number
inch	inch	inch	inch	inch x 45°			
5/16	5/16	2 1/2	13/16	0.004	6	7.940	9031150079400
3/8	3/8	2 1/2	1	0.004	6	9.520	9031150095200
1/2	1/2	3	1	0.006	6	12.700	9031150127000
5/8	5/8	3 1/2	1 1/4	0.006	6	15.870	9031150158700
3/4	3/4	4	1 1/2	0.006	6	19.050	9031150190500
1	1	4	1 1/2	0.012	6	25.400	9031150254000

# RF 100 S/F (6-flute) - Metric - Standard Length



## center cutting



Standard



No. Flutes  
6



Helix angle



Chamfer  
45°



Rake Angle  
7°



Finishing



HA



HB

Tool material

Solid Carbide

Surface finish

FIREX®

Series

3631

3632

Application group	Material examples	Ideal for
P	Steel	●
M	Stainless steel	●
K	Cast iron	●
N	Aluminum	○
S	Ni / Ti alloys	●
H	Hardened steel	○

●=Optimal    ○=Secondary

Speed and Feed data found on page 302

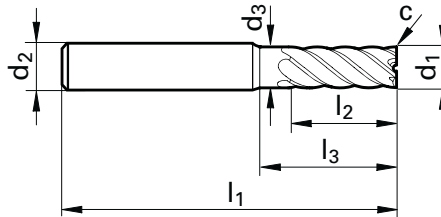

d1 h10	d2 h6	d3	l1	l2	l3	c	No. of Flutes	Code no.	EDP Number	
mm	mm	mm	mm	mm	mm	mm x 45°				
8.000	8.000	7.700	63.00	19.00	26.00	0.10	6	8.000	9036310080000	9036320080000
10.000	10.000	9.500	72.00	22.00	30.00	0.10	6	10.000	9036310100000	9036320100000
12.000	12.000	11.500	83.00	26.00	36.00	0.10	6	12.000	9036310120000	9036320120000
16.000	16.000	15.500	92.00	32.00	42.00	0.15	6	16.000	9036310160000	9036320160000
20.000	20.000	19.500	104.00	38.00	52.00	0.15	6	20.000	9036310200000	9036320200000
25.000	25.000	24.000	121.00	45.00	63.00	0.20	6	25.000	9036310250000	9036320250000



# DIAMOND- FOR COMPOSITE AND AEROSPACE MATERIALS

# TECH



# Special solutions for special requirements



PCD End Mill · Guhring series 5493

## Summary of advantages

- Individual solutions for the highly accurate and productive machining of small to large diameters
- Special requirements necessitate special solutions, therefore, tools are manufactured taking the customer requirements into consideration
- PCD/CBN special tools enable maximum machine capacity utilization, increasing the production capacity, tight tolerances, optimal surface qualities, maximum cutting speeds and essential process reliability
- It is also possible to reduce the set-up times for mass production components due to the longer tool life

## PCD Slot Drills (2-flute) - Inch - Standard Length

for aluminum and composites

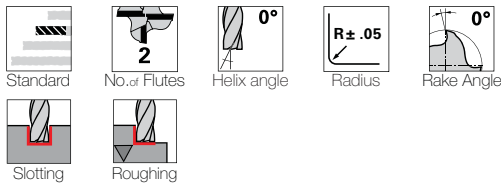

Tool material

PCD

Surface finish

Bright

Series

3867

Application group	Material examples	Ideal for
P	Steel	—
M	Stainless steel	—
K	Cast iron	—
N	Aluminum	●
S	Ni / Ti alloys	—
H	Hardened steel	—
	Composites	●

●=Optimal    ○=Secondary

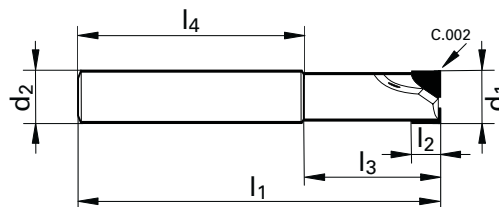

d1 e10	d2 h6	l1	l2	l3	l4	No. of Flutes	Code no.	EDP Number
inch	inch	inch	inch	inch	inch			
1/4	1/4	2 1/2	3/4	1 1/16	1 7/16	2	6.350	9038670063500
3/8	3/8	3	3/4	1 1/4	1 3/4	2	9.520	9038670095200
1/2	1/2	3	1	1 5/16	1 11/16	2	12.700	9038670127000
3/4	3/4	4	1	1 5/8	2 3/8	2	19.050	9038670190500

# PCD Slot Drills (3-flute) - Inch - Standard Length

for aluminum and composites



Standard



No. Flutes



Helix angle



Radius



Rake Angle



Slotting



Roughing



Tool material

PCD

Surface finish

Bright

Series

3870

Application group	Material examples	Ideal for
P	Steel	—
M	Stainless steel	—
K	Cast iron	—
N	Aluminum	●
S	Ni / Ti alloys	—
H	Hardened steel	—
	Composites	●

●=Optimal    ○=Secondary

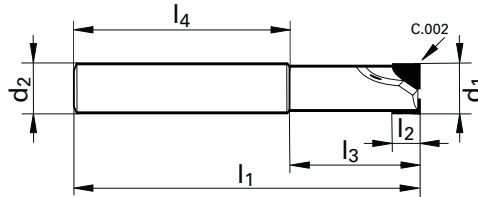

d1 e10	d2 h6	l1	l2	l3	l4	No. of Flutes	Code no.	EDP Number
inch	inch	inch	inch	inch	inch			
1/2	1/2	3	1/2	1 5/16	1 11/16	3	12.700	9038700127000
3/4	3/4	3	1/2	1	2	3	19.050	9038700190500
1	1	4	1	1 5/8	2 3/8	3	25.400	9038700254000

## Cutting values: Slotting\*, HPC-roughing and copy milling

ISO Code	Hardness	Cutting Speed SFM	Feed Inch Per Tooth (IPT) with nom. Dia				
			1/4	3/8	1/2	3/4	1
N Aluminium	less than 7% Si	1970	0.0015	0.0023	0.0029	0.0038	0.0040
	Up to 17% Si	850	0.0013	0.0019	0.0025	0.0034	0.0036
Graphite	up to 8 micron grain size	1475	0.0025	0.0038	0.0050	0.0068	0.0072
Composites	over 50% fiber content	980	0.0013	0.0019	0.0025	0.0034	0.0036

\* peripheral cooling "Guhrojet" is recommended for optimal chip evacuation and tool life, for graphite and Kevlar-machining air cooling

\*\* at lower feed width the cutting speed  $v_c$  and feed rate  $f_z$  can be increased by 30%

# PCD Slot Drills (2-flute) - Metric - Standard Length - Coolant Fed



for aluminum and composites

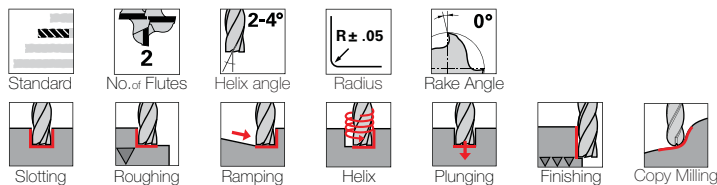

Tool material

PCD

Surface finish

bright

Series

5492

Application group	Material examples	Ideal for
P	Steel	—
M	Stainless steel	—
K	Cast iron	—
N	Aluminum	●
S	Ni / Ti alloys	—
H	Hardened steel	—
	Composites	●

●=Optimal ○=Secondary

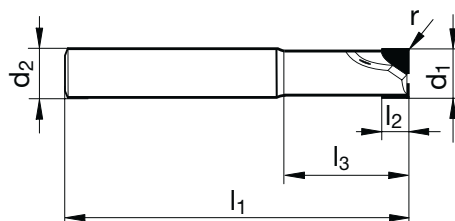

d1	tol. d1	d2 h6	l1	l2	l3	r	No. of Flutes	Code no.	EDP Number
mm	mm	mm	mm	mm	mm	mm			
4.000	± 0,02	6.000	51.00	6.00	6.40	0.10	2	4.000	9054920040000
5.000	± 0,02	6.000	51.00	8.00	8.40	0.10	2	5.000	9054920050000
6.000	± 0,02	6.000	57.00	8.00	21.00	0.10	2	6.000	9054920060000
8.000	± 0,02	8.000	63.00	8.00	27.00	0.10	2	8.000	9054920080000
8.000	± 0,02	8.000	63.00	12.00	27.00	0.10	2	8.001	9054920080010
10.000	± 0,02	10.000	72.00	8.00	32.00	0.10	2	10.000	9054920100000
10.000	± 0,02	10.000	72.00	16.00	32.00	0.10	2	10.001	9054920100010
12.000	± 0,02	12.000	83.00	8.00	38.00	0.10	2	12.000	9054920120000
12.000	± 0,02	12.000	83.00	16.00	38.00	0.10	2	12.001	9054920120010
14.000	± 0,02	14.000	83.00	8.00	38.00	0.10	2	14.000	9054920140000
14.000	± 0,02	14.000	83.00	16.00	38.00	0.10	2	14.001	9054920140010
16.000	± 0,02	16.000	100.00	12.00	52.00	0.10	2	16.000	9054920160000
16.000	± 0,02	16.000	100.00	20.00	52.00	0.10	2	16.001	9054920160010
18.000	± 0,02	18.000	100.00	12.00	52.00	0.10	2	18.000	9054920180000
18.000	± 0,02	18.000	100.00	20.00	52.00	0.10	2	18.001	9054920180010
20.000	± 0,02	20.000	100.00	12.00	50.00	0.10	2	20.000	9054920200000
20.000	± 0,02	20.000	100.00	20.00	50.00	0.10	2	20.001	9054920200010

## Cutting values: Slotting\*, HPC-roughing and copy milling

Type	Characteristic	Feed depth $a_p$	Feed width** $a_e$	Cutting speed $v_c$	fz (mm/z) with nom. Ø						
					4	6	8	10	12	16	20
N Aluminium	up to 7% Si	—	—	—	—	—	—	—	—	—	—
	up to 17% Si	0.5xd	1xd	220	0.02	0.03	0.04	0.05	0.06	0.07	0.09
Graphite	up to 8 µm grain size	1.5xd	1xd	350	0.04	0.06	0.08	0.1	0.12	0.15	0.18
Composites	over 50% fiber content	1xd	1xd	200	0.015	0.03	0.04	0.05	0.06	0.08	0.09

\* peripheral cooling "Guhrojet" is recommended for optimal chip evacuation and tool life, for graphite and Kevlar-machining air cooling

\*\* at lower feed width the cutting speed  $v_c$  and feed rate  $f_z$  can be increased by 30%

# PCD Slot Drills (2-flute) - Metric - Long Length - Coolant Fed



for aluminum and composites

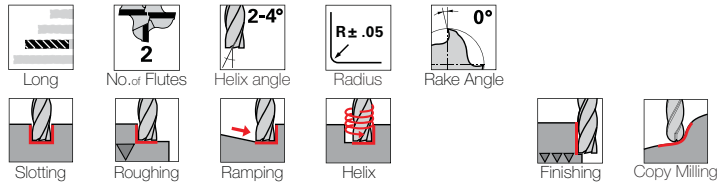

Tool material  
Surface finish

**PCD**

bright

Series

**5493**

Application group	Material examples	Ideal for
<b>P</b>	Steel	—
<b>M</b>	Stainless steel	—
<b>K</b>	Cast iron	—
<b>N</b>	Aluminum	●
<b>S</b>	Ni / Ti alloys	—
<b>H</b>	Hardened steel	—
	Composites	●

●=Optimal    ○=Secondary

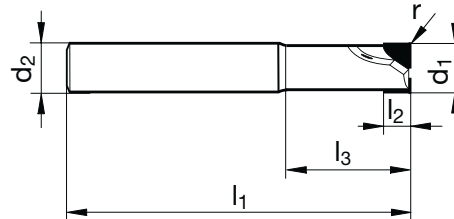

d1	tol. d1	d2 h6	l1	l2	l3	r	No. of Flutes	Code no.	EDP Number
mm	mm	mm	mm	mm	mm	mm			
4.000	± 0,02	6.000	70.00	6.00	6.40	0.10	2	4.000	9054930040000
5.000	± 0,02	6.000	70.00	8.00	8.40	0.10	2	5.000	9054930050000
6.000	± 0,02	6.000	75.00	8.00	21.00	0.10	2	6.000	9054930060000
8.000	± 0,02	8.000	100.00	8.00	27.00	0.10	2	8.000	9054930080000
8.000	± 0,02	8.000	100.00	12.00	27.00	0.10	2	8.001	9054930080010
10.000	± 0,02	10.000	100.00	8.00	32.00	0.10	2	10.000	9054930100000
10.000	± 0,02	10.000	100.00	16.00	32.00	0.10	2	10.001	9054930100010
12.000	± 0,02	12.000	100.00	8.00	38.00	0.10	2	12.000	9054930120000
12.000	± 0,02	12.000	100.00	16.00	38.00	0.10	2	12.001	9054930120010
14.000	± 0,02	14.000	100.00	8.00	38.00	0.10	2	14.000	9054930140000
14.000	± 0,02	14.000	100.00	16.00	38.00	0.10	2	14.001	9054930140010
16.000	± 0,02	16.000	150.00	12.00	52.00	0.10	2	16.000	9054930160000
16.000	± 0,02	16.000	150.00	20.00	52.00	0.10	2	16.001	9054930160010
18.000	± 0,02	18.000	125.00	12.00	52.00	0.10	2	18.000	9054930180000
18.000	± 0,02	18.000	125.00	20.00	52.00	0.10	2	18.001	9054930180010
18.000	± 0,02	18.000	150.00	20.00	52.00	0.10	2	18.002	9054930180020
18.000	± 0,02	18.000	150.00	12.00	52.00	0.10	2	18.003	9054930180030
20.000	± 0,02	20.000	150.00	12.00	50.00	0.10	2	20.000	9054930200000
20.000	± 0,02	20.000	150.00	20.00	50.00	0.10	2	20.001	9054930200010

### Cutting values: Slotting\*, HPC-roughing and copy milling

Type	Characteristic	Feed depth $a_p$	Feed width** $a_e$	Cutting speed $v_c$	fz (mm/z) with nom. Ø						
					4	6	8	10	12	16	20
N Aluminium	up to 7% Si	—	—	—	—	—	—	—	—	—	—
	up to 17% Si	0.5xd	1xd	220	0.02	0.03	0.04	0.05	0.06	0.07	0.09
Graphite	up to 8 µm grain size	1.5xd	1xd	350	0.04	0.06	0.08	0.1	0.12	0.15	0.18
Composites	over 50% fiber content	1xd	1xd	200	0.015	0.03	0.04	0.05	0.06	0.08	0.09

\* peripheral cooling "Guhrojet" is recommended for optimal chip evacuation and tool life, for graphite and Kevlar-machining air cooling

\*\* at lower feed width the cutting speed  $v_c$  and feed rate  $f_z$  can be increased by 30%



# PCD Slot Drills (3-flute) - Metric - Standard Length - Coolant Fed



for aluminum and composites

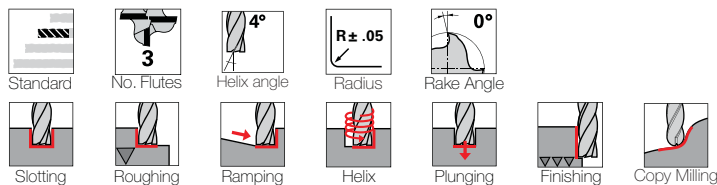

Tool material

PCD

Surface finish

bright

Series

5495

Application group	Material examples	Ideal for
P	Steel	—
M	Stainless steel	—
K	Cast iron	—
N	Aluminum	●
S	Ni / Ti alloys	—
H	Hardened steel	—
	Composites	●

●=Optimal    ○=Secondary

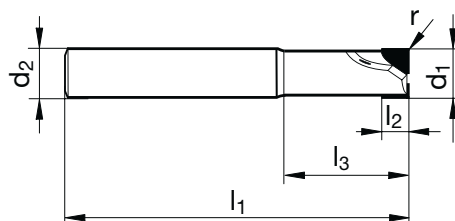

d1	tol. d1	d2 h6	l1	l2	l3	r	No. of Flutes	Code no.	EDP Number
mm	mm	mm	mm	mm	mm	mm			
14.000	± 0,02	14.000	83.00	8.00	38.00	0.10	3	14.000	9054950140000
14.000	± 0,02	14.000	83.00	16.00	38.00	0.10	3	14.001	9054950140010
16.000	± 0,02	16.000	100.00	12.00	52.00	0.10	3	16.000	9054950160000
16.000	± 0,02	16.000	100.00	20.00	52.00	0.10	3	16.001	9054950160010
18.000	± 0,02	18.000	100.00	12.00	52.00	0.10	3	18.000	9054950180000
18.000	± 0,02	18.000	100.00	20.00	52.00	0.10	3	18.001	9054950180010
20.000	± 0,02	20.000	100.00	12.00	50.00	0.10	3	20.000	9054950200000
20.000	± 0,02	20.000	100.00	20.00	50.00	0.10	3	20.001	9054950200010

## Cutting values: Slotting\*, HPC-roughing and copy milling

Type	Characteristic	Feed depth $a_p$	Feed width** $a_e$	Cutting speed $v_c$	fz (mm/z) with nom. Ø						
					4	6	8	10	12	16	20
N Aluminium	up to 7% Si	—	—	—	—	—	—	—	—	—	—
	up to 17% Si	0.5xd	1xd	220	0.02	0.03	0.04	0.05	0.06	0.07	0.09
Graphite	up to 8 µm grain size	1.5xd	1xd	350	0.04	0.06	0.08	0.1	0.12	0.15	0.18
Composites	over 50% fiber content	1xd	1xd	200	0.015	0.03	0.04	0.05	0.06	0.08	0.09

\* peripheral cooling "Guhrojet" is recommended for optimal chip evacuation and tool life, for graphite and Kevlar-machining air cooling

\*\* at lower feed width the cutting speed  $v_c$  and feed rate  $f_z$  can be increased by 30%

# PCD Slot Drills (3-flute) - Metric - Standard Length - Coolant Fed



for aluminum and composites

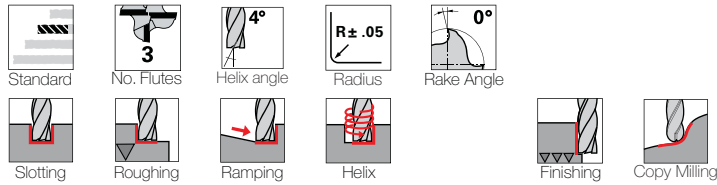

Tool material  
Surface finish

**PCD**

bright

Series

**5496**

Application group	Material examples	Ideal for
P	Steel	—
M	Stainless steel	—
K	Cast iron	—
N	Aluminum	●
S	Ni / Ti alloys	—
H	Hardened steel	—
	Composites	●

●=Optimal    ○=Secondary

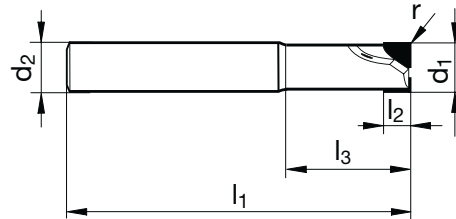

d1	tol. d1	d2 h6	l1	l2	l3	r	No. of Flutes	Code no.	EDP Number
mm	mm	mm	mm	mm	mm	mm			
14.000	± 0,02	14.000	100.00	8.00	38.00	0.10	3	14.000	9054960140000
14.000	± 0,02	14.000	100.00	16.00	38.00	0.10	3	14.001	9054960140010
16.000	± 0,02	16.000	150.00	12.00	52.00	0.10	3	16.000	9054960160000
16.000	± 0,02	16.000	150.00	20.00	52.00	0.10	3	16.001	9054960160010
18.000	± 0,02	18.000	150.00	12.00	52.00	0.10	3	18.000	9054960180000
18.000	± 0,02	18.000	150.00	20.00	52.00	0.10	3	18.001	9054960180010
20.000	± 0,02	20.000	150.00	12.00	50.00	0.10	3	20.000	9054960200000
20.000	± 0,02	20.000	150.00	20.00	50.00	0.10	3	20.001	9054960200010

## Cutting values: Slotting\*, HPC-roughing and copy milling

Type	Characteristic	Feed depth $a_p$	Feed width** $a_e$	Cutting speed $v_c$	fz (mm/z) with nom. Ø						
					4	6	8	10	12	16	20
N Aluminium	up to 7% Si	—	—	—	—	—	—	—	—	—	—
	up to 17% Si	0.5xd	1xd	220	0.02	0.03	0.04	0.05	0.06	0.07	0.09
Graphite	up to 8 µm grain size	1.5xd	1xd	350	0.04	0.06	0.08	0.1	0.12	0.15	0.18
Composites	over 50% fiber content	1xd	1xd	200	0.015	0.03	0.04	0.05	0.06	0.08	0.09

\* peripheral cooling "Guhrojet" is recommended for optimal chip evacuation and tool life, for graphite and Kevlar-machining air cooling

\*\* at lower feed width the cutting speed  $v_c$  and feed rate  $f_z$  can be increased by 30%

# CR 100

Aerospace routers  
for CFC and similar compounds



Typical delamination on a milled CFC workpiece edge

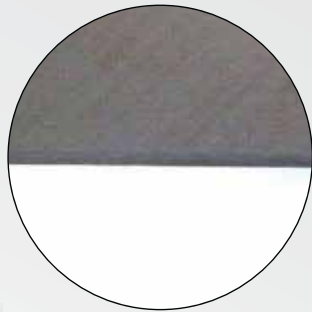

Milled CFC workpiece edge without delamination machined with a Guhring CR 100 end mill

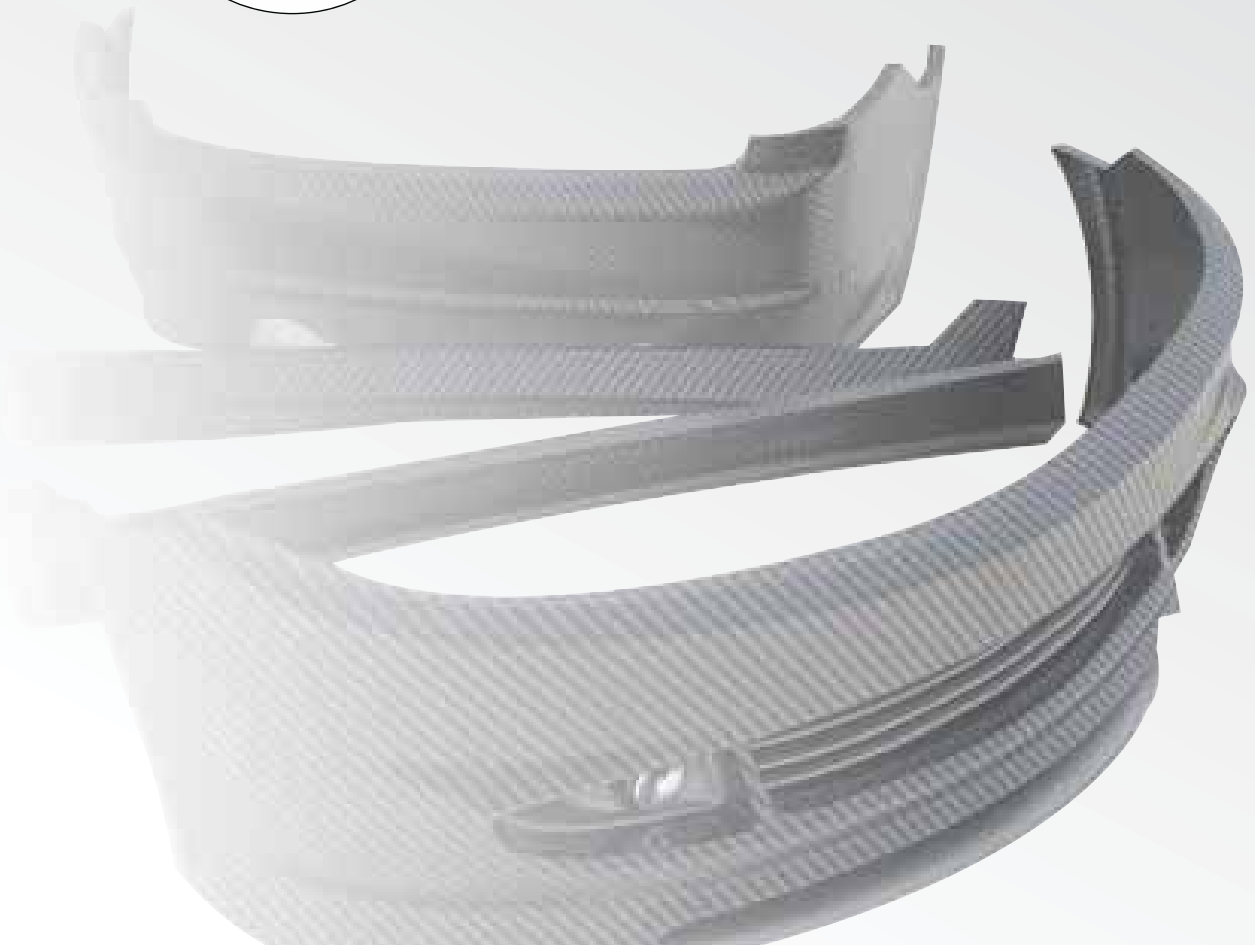

# Carbide Aerospace Routers CR 100 - Inch - Square

for fiber-reinforced plastics

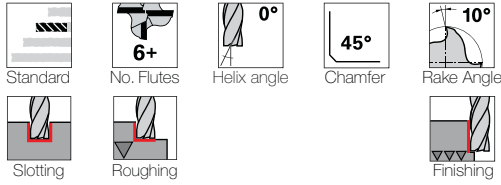

Tool material

**Solid Carbide**

Surface finish

Diamond Coated

Application group	Material examples	Ideal for
<b>P</b>	Steel	—
<b>M</b>	Stainless steel	—
<b>K</b>	Cast iron	—
<b>N</b>	Aluminum	—
<b>S</b>	Ni / Ti alloys	—
<b>H</b>	Hardened steel	—
	Composites	●

●=Optimal ○=Secondary

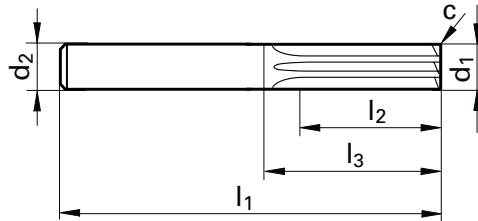

d1 e10	d2 h6	l1	l2	l3	c	No. of Flutes	Order Number
inch	inch	inch	inch	inch	inch x 45°		
1/4	1/4	2 1/2	3/4	1.32	0.15	10	302284000
3/8	3/8	3	1	1.58	0.15	14	302284001
1/2	1/2	3 1/2	1 1/4	1.93	0.15	15	302284002
5/8	5/8	4	1 5/8	2.43	0.15	15	302284003

# Carbide Aerospace Routers CR 100 - Inch - Plunging

for fiber-reinforced plastics

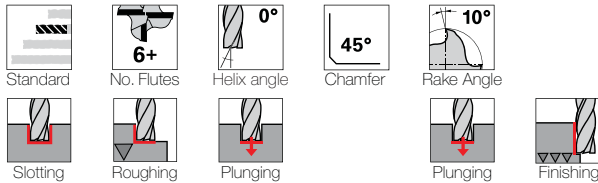

Tool material

**Solid Carbide**

Surface finish

Diamond Coated

Application group	Material examples	Ideal for
<b>P</b>	Steel	—
<b>M</b>	Stainless steel	—
<b>K</b>	Cast iron	—
<b>N</b>	Aluminum	—
<b>S</b>	Ni / Ti alloys	—
<b>H</b>	Hardened steel	—
	Composites	●

●=Optimal ○=Secondary

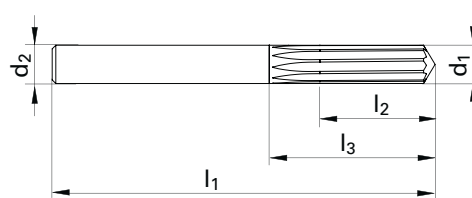

d1 e10	d2 h6	l1	l2	l3	No. of Flutes	Order Number
inch	inch	inch	inch	inch		
1/4	1/4	2-1/2	3/4	1.08	10	302284015
3/8	3/8	3	1	1.43	14	302284016
1/2	1/2	3-1/2	1-1/4	1.73	15	302284017
5/8	5/8	4	1-5/8	2.24	15	302284018

# Carbide Aerospace Routers CR 100

for fiber-reinforced plastics



Standard



No. Flutes



Helix angle



Chamfer



Rake Angle



Slotting



Roughing



Finishing



Tool material

**Solid Carbide**

Surface finish

Diamond Coated

Series

**6717**

Application group	Material examples	Ideal for
<b>P</b>	Steel	—
<b>M</b>	Stainless steel	—
<b>K</b>	Cast iron	—
<b>N</b>	Aluminum	—
<b>S</b>	Ni / Ti alloys	—
<b>H</b>	Hardened steel	—
	Composites	●

●=Optimal ○=Secondary

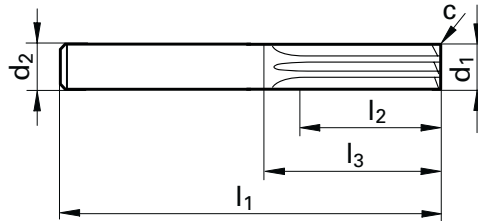

d1 e10	d2 h6	l1	l2	l3	c	No. of Flutes	Code no.	EDP Number
mm	mm	mm	mm	mm	mm x 45°			
4.000	6.000	57.00	10.00	19.40	0.10	6	4.000	9067170040000
6.000	6.000	65.00	15.00	29.00	0.15	8	6.000	9067170060000
8.000	8.000	75.00	20.00	39.00	0.15	10	8.000	9067170080000
10.000	10.000	80.00	25.00	40.00	0.15	12	10.000	9067170100000
12.000	12.000	93.00	32.00	48.00	0.15	14	12.000	9067170120000
16.000	16.000	108.00	34.00	60.00	0.15	14	16.000	9067170160000

## Cutting values: Slotting\*, HPC-roughing and copy milling

Type	Characteristic	Feed depth $a_p$	Feed width** $a_e$	Cutting speed $v_c$	fz (mm/z) with nom. Ø						
					4	6	8	10	12	16	20
<b>N</b>	up to 7% Si	—	—	—	—	—	—	—	—	—	—
<b>Aluminium</b>	up to 17% Si	0.5xd	1xd	220	0.02	0.03	0.04	0.05	0.06	0.07	0.09
<b>Graphite</b>	up to 8 µm grain size	1.5xd	1xd	350	0.04	0.06	0.08	0.1	0.12	0.15	0.18
<b>Composites</b>	over 50% fiber content	1xd	1xd	200	0.015	0.03	0.04	0.05	0.06	0.08	0.09

\* peripheral cooling "Guhrojet" is recommended for optimal chip evacuation and tool life, for graphite and Kevlar-machining air cooling

\*\* at lower feed width the cutting speed  $v_c$  and feed rate  $fz$  can be increased by 30%

# Carbide Aerospace Routers CR 100 - Coolant Fed



## center cutting for fiber-reinforced plastics

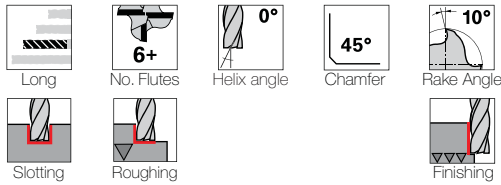

Tool material

**Solid Carbide**

Surface finish

Diamond Coated

Series

**6718**

Application group	Material examples	Ideal for
<b>P</b>	Steel	—
<b>M</b>	Stainless steel	—
<b>K</b>	Cast iron	—
<b>N</b>	Aluminum	—
<b>S</b>	Ni / Ti alloys	—
<b>H</b>	Hardened steel	—
	Composites	●

●=Optimal    ○=Secondary

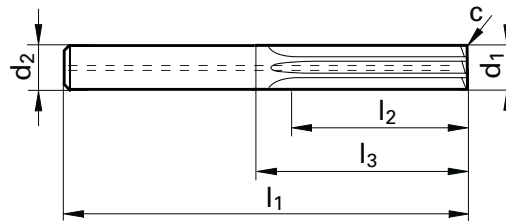

d1 e10	d2 h6	l1	l2	l3	c	No. of Flutes	Code no.	EDP Number
mm	mm	mm	mm	mm	mm x 45°			
6.000	6.000	70.00	24.00	34.00	0.15	8	6.000	9067180060000
8.000	8.000	80.00	32.00	44.00	0.15	10	8.000	9067180080000
10.000	10.000	90.00	40.00	50.00	0.15	12	10.000	9067180100000
12.000	12.000	110.00	48.00	65.00	0.15	14	12.000	9067180120000
16.000	16.000	130.00	64.00	82.00	0.15	14	16.000	9067180160000

### Cutting values: Slotting\*, HPC-roughing and copy milling

Type	Characteristic	Feed depth $a_p$	Feed width** $a_e$	Cutting speed $v_c$	fz (mm/z) with nom. Ø						
					4	6	8	10	12	16	20
<b>N</b> Aluminium	up to 7% Si	—	—	—	—	—	—	—	—	—	—
	up to 17% Si	0.5xd	1xd	220	0.02	0.03	0.04	0.05	0.06	0.07	0.09
<b>Graphite</b>	up to 8 µm grain size	1.5xd	1xd	350	0.04	0.06	0.08	0.1	0.12	0.15	0.18
<b>Composites</b>	over 50% fiber content	1xd	1xd	200	0.015	0.03	0.04	0.05	0.06	0.08	0.09

\* peripheral cooling "Guhrojet" is recommended for optimal chip evacuation and tool life, for graphite and Kevlar-machining air cooling

\*\* at lower feed width the cutting speed  $v_c$  and feed rate  $f_z$  can be increased by 30%

# Carbide Aerospace Routers CR 100

for fiber-reinforced plastics

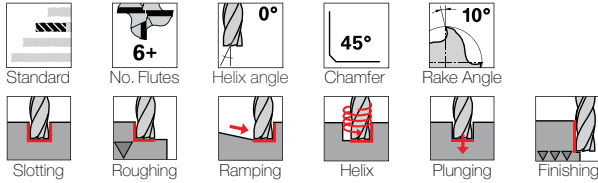

Tool material

**Solid Carbide**

Surface finish

Diamond Coated

Series

**6719**

Application group	Material examples	Ideal for
<b>P</b>	Steel	—
<b>M</b>	Stainless steel	—
<b>K</b>	Cast iron	—
<b>N</b>	Aluminum	—
<b>S</b>	Ni / Ti alloys	—
<b>H</b>	Hardened steel	—
	Composites	●

●=Optimal   ○=Secondary

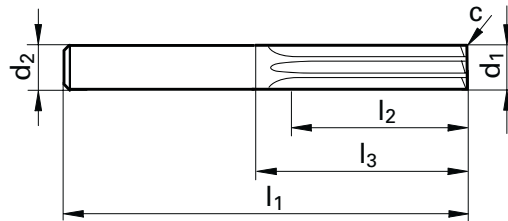

d1 e10	d2 h6	l1	l2	l3	c	No. of Flutes	Code no.	EDP Number
mm	mm	mm	mm	mm	mm x 45°			
4.000	6.000	57.00	10.00	19.40	0.10	6	4.000	9067190040000
6.000	6.000	65.00	15.00	29.00	0.15	8	6.000	9067190060000
8.000	8.000	75.00	20.00	39.00	0.15	10	8.000	9067190080000
10.000	10.000	80.00	25.00	40.00	0.15	12	10.000	9067190100000
12.000	12.000	93.00	32.00	48.00	0.15	14	12.000	9067190120000
16.000	16.000	108.00	34.00	60.00	0.15	14	16.000	9067190160000

## Cutting values: Slotting\*, HPC-roughing and copy milling

Type	Characteristic	Feed depth $a_p$	Feed width** $a_e$	Cutting speed $v_c$	fz (mm/z) with nom. Ø						
					4	6	8	10	12	16	20
<b>N</b> Aluminium	up to 7% Si	—	—	—	—	—	—	—	—	—	—
	up to 17% Si	0.5xd	1xd	220	0.02	0.03	0.04	0.05	0.06	0.07	0.09
<b>Graphite</b>	up to 8 µm grain size	1.5xd	1xd	350	0.04	0.06	0.08	0.1	0.12	0.15	0.18
<b>Composites</b>	over 50% fiber content	1xd	1xd	200	0.015	0.03	0.04	0.05	0.06	0.08	0.09

\* peripheral cooling "Guhrojet" is recommended for optimal chip evacuation and tool life, for graphite and Kevlar-machining air cooling

\*\* at lower feed width the cutting speed  $v_c$  and feed rate  $f_z$  can be increased by 30%

# Carbide Aerospace Routers CR 100

for fiber-reinforced plastics



Standard



No. Flutes



Helix angle



Rake Angle



Slotting



Roughing



Plunging



Finishing



Tool material

Solid Carbide

Surface finish

Diamond Coated

Series

6720

Application group	Material examples	Ideal for
P	Steel	—
M	Stainless steel	—
K	Cast iron	—
N	Aluminum	—
S	Ni / Ti alloys	—
H	Hardened steel	—
	Composites	●

●=Optimal ○=Secondary

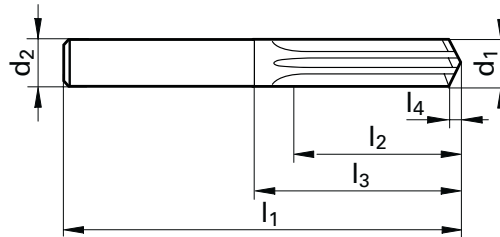

d1 e10	d2 h6	l1	l2	l3	l4	No. of Flutes	Code no.	EDP Number
mm	mm	mm	mm	mm	mm			
4.000	4.000	55.00	12.00	27.00	1.30	6	4.000	9067200040000
6.000	6.000	65.00	18.00	29.00	1.90	8	6.000	9067200060000
8.000	8.000	75.00	24.00	39.00	2.50	10	8.000	9067200080000
10.000	10.000	80.00	30.00	40.00	3.10	12	10.000	9067200100000
12.000	12.000	93.00	36.00	48.00	3.70	14	12.000	9067200120000
16.000	16.000	108.00	48.00	60.00	4.90	14	16.000	9067200160000

## Cutting values: Slotting\*, HPC-roughing and copy milling

Type	Characteristic	Feed depth $a_p$	Feed width** $a_e$	Cutting speed $v_c$	fz (mm/z) with nom. Ø						
					4	6	8	10	12	16	20
N Aluminium	up to 7% Si	—	—	—	—	—	—	—	—	—	—
	up to 17% Si	0.5xd	1xd	220	0.02	0.03	0.04	0.05	0.06	0.07	0.09
Graphite	up to 8 µm grain size	1.5xd	1xd	350	0.04	0.06	0.08	0.1	0.12	0.15	0.18
Composites	over 50% fiber content	1xd	1xd	200	0.015	0.03	0.04	0.05	0.06	0.08	0.09

\* peripheral cooling "Guhrojet" is recommended for optimal chip evacuation and tool life, for graphite and Kevlar-machining air cooling

\*\* at lower feed width the cutting speed  $v_c$  and feed rate  $f_z$  can be increased by 30%





# TECH-LINE

MATERIAL SPECIFIC



# AERO-TECH GH 100 U

## High-performance end mills

The new design Guhring GH 100 U end mills offer the ultimate prerequisite for a cost-efficient, optimal machining of general steels, high-alloyed steels, CrNi steels as well as stainless steels and titanium-alloys up to 50 HRC.

All GH 100 U end mills excel thanks to their micro-corner protection combined with a reinforced and corrected minor cutting edge. This design considerably reduces the wear at the cutting edges allowing a higher feed rate as well as improved tool life.

GH 100 U end mills (3-flute) excel further thanks to their optimized flute geometry, achieving ultimate machining efficiency especially for slot milling and roughing operations. Paired with a very high spiral, optimal chip evacuation is achieved while reducing vibration.

### The advantages:

- Reduced wear
- High feed rates possible
- Optimal chip evacuation
- Can be applied for roughing and finishing

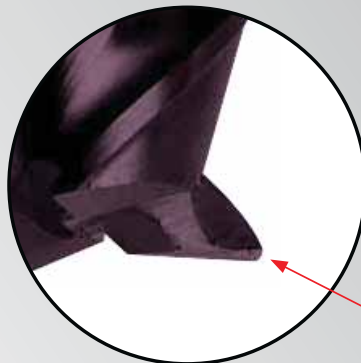

Micro-corner protection and corrected reinforced cutting edge = optimal stability

# Aero-Tech GH100 U (3-flute) - Inch - Stub length

## center cutting

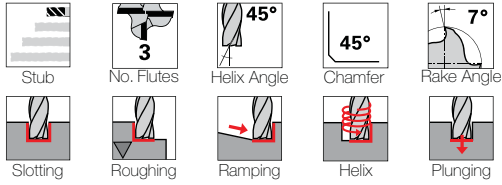

**F**

HA

Tool material

**Solid Carbide**

Surface finish

FIREX®

Series

**3086**

Application group	Material examples	Ideal for
<b>P</b>	Steel	●
<b>M</b>	Stainless steel	●
<b>K</b>	Cast iron	●
<b>N</b>	Aluminum	○
<b>S</b>	Ni / Ti alloys	○
<b>H</b>	Hardened steel	--

●=Optimal    ○=Secondary

Speed and Feed data found on page 293

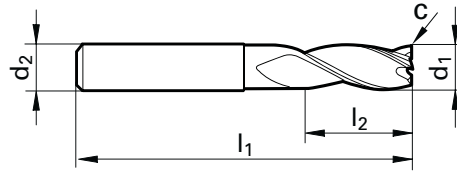

d1 h10	d2 h6	l1	l2	Chamfer	No. of Flutes	Code no.	EDP Number
inch	inch	inch	inch	inch			
1/16	1/8	1 1/2	1/8	0.001	3	1.590	9030860015900
1/8	1/8	2	1/4	0.002	3	3.170	9030860031700
3/16	3/16	2	3/8	0.002	3	4.760	9030860047600
1/4	1/4	2	1/2	0.004	3	6.350	9030860063500
5/16	5/16	2	1/2	0.004	3	7.940	9030860079400
3/8	3/8	2	5/8	0.004	3	9.520	9030860095200
7/16	7/16	2 1/2	5/8	0.006	3	11.110	9030860111100
1/2	1/2	2 1/2	5/8	0.006	3	12.700	9030860127000

# Aero-Tech GH100 U (3-flute) - Metric - Stub Length

## center cutting

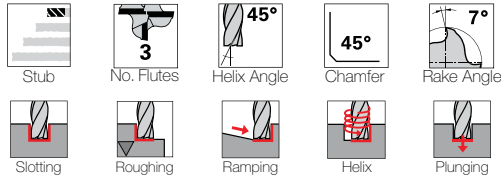

Tool material

**Solid Carbide**

Surface finish

FIREX®

FIREX®

Series

3540

3729

Application group	Material examples	Ideal for
P	Steel	●
M	Stainless steel	●
K	Cast iron	●
N	Aluminum	○
S	Ni / Ti alloys	○
H	Hardened steel	--

●=Optimal ○=Secondary

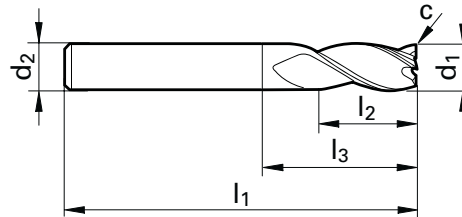

Speed and Feed data found on page 305

d1 h10	d2 h6	l1	l2	l3	c	No. of Flutes	Code no.	EDP Number	
mm	mm	mm	mm	mm	mm x 45°				
3.000	6.000	50.00	4.00	7.90	0.03	3	3.000	9035400030000	9037290030000
4.000	6.000	54.00	5.00	8.90	0.06	3	4.000	9035400040000	9037290040000
5.000	6.000	54.00	6.00	11.40	0.08	3	5.000	9035400050000	9037290050000
6.000	6.000	54.00	7.00	18.00	0.09	3	6.000	9035400060000	9037290060000
7.000	8.000	58.00	8.00	16.40	0.11	3	7.000	9035400070000	9037290070000
8.000	8.000	58.00	9.00	22.00	0.12	3	8.000	9035400080000	9037290080000
9.000	10.000	66.00	10.00	19.40	0.14	3	9.000	9035400090000	9037290090000
10.000	10.000	66.00	11.00	26.00	0.15	3	10.000	9035400100000	9037290100000
12.000	12.000	73.00	12.00	28.00	0.18	3	12.000	9035400120000	9037290120000
14.000	14.000	75.00	14.00	30.00	0.21	3	14.000	9035400140000	9037290140000
16.000	16.000	82.00	16.00	34.00	0.19	3	16.000	9035400160000	9037290160000
18.000	18.000	84.00	18.00	36.00	0.22	3	18.000	9035400180000	9037290180000
20.000	20.000	92.00	20.00	42.00	0.24	3	20.000	9035400200000	9037290200000

# HSC

## ADVANTAGES AT A GLANCE

- absolutely precise diameter tolerances
- close radius tolerances
- radius point grind with constant helix correction
- cylinder and radius areas ground in one-pass process
- grinding procedure for highest surface qualities



Seamless  
radius area



Optimal  
wear-protection

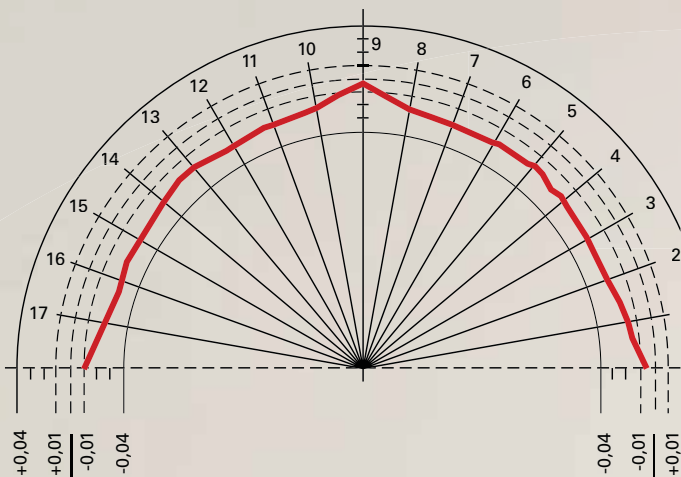

Radius accuracy of competitor milling cutter  
( $\pm 0.06$  mm)

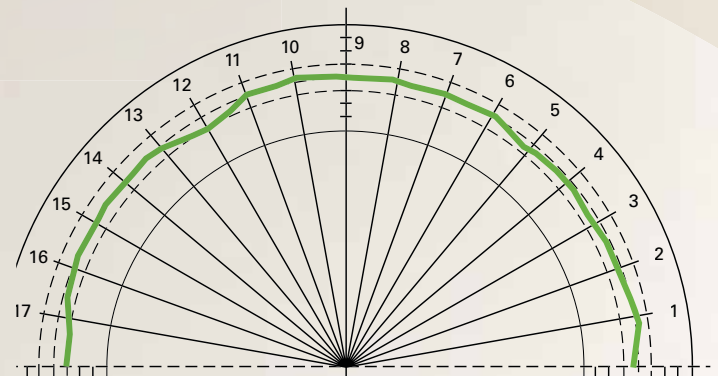

GF 500 radius in tolerance area  
 $\pm 0.01$  mm

# Aero-Tech GH100 U (3-flute) - Inch - Standard Length

## center cutting

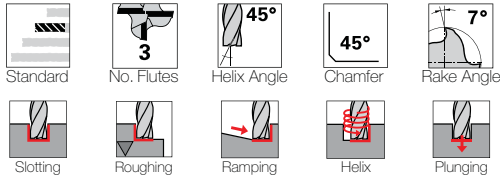

Tool material

**Solid Carbide**

**Solid Carbide**

Surface finish

bright

FIREX®

Series

**3172**

**3173**

Application group	Material examples	Ideal for
<b>P</b>	Steel	●
<b>M</b>	Stainless steel	●
<b>K</b>	Cast iron	●
<b>N</b>	Aluminum	●
<b>S</b>	Ni / Ti alloys	○
<b>H</b>	Hardened steel	--

●=Optimal    ○=Secondary

Speed and Feed data found on page 293

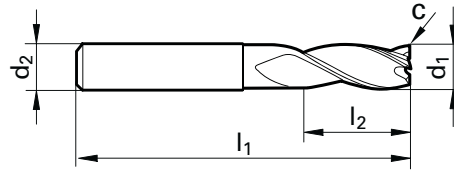

d1 h10	d2 h6	l1	l2	Chamfer	No. of Flutes	Code no.	EDP Number	
inch	inch	inch	inch	inch				
1/8	1/8	1 1/2	3/8	0.002	3	3.170	9031720031700	9031730031700
3/16	3/16	2	5/8	0.002	3	4.760	9031720047600	9031730047600
1/4	1/4	2 1/2	3/4	0.004	3	6.350	9031720063500	9031730063500
5/16	5/16	2 1/2	13/16	0.004	3	7.940	9031720079400	9031730079400
3/8	3/8	2 1/2	1	0.004	3	9.520	9031720095200	9031730095200
7/16	7/16	2 3/4	1	0.006	3	11.110	9031720111100	9031730111100
1/2	1/2	3	1	0.006	3	12.700	9031720127000	9031730127000
5/8	5/8	3 1/2	1 1/4	0.006	3	15.870	9031720158700	9031730158700
3/4	3/4	4	1 1/2	0.006	3	19.050	9031720190500	9031730190500
1	1	4	1 1/2	0.012	3	25.400	9031720254000	9031730254000

# Aero-Tech GH100 U (3-flute) - Metric - Standard Length

## center cutting

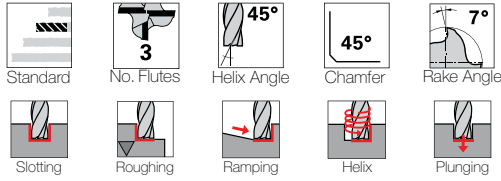

Tool material

Solid Carbide

Surface finish

bright

FIREX®

Series

3203

3741

Application group	Material examples	Ideal for
P	Steel	●
M	Stainless steel	●
K	Cast iron	●
N	Aluminum	●
S	Ni / Ti alloys	○
H	Hardened steel	--

●=Optimal ○=Secondary

Speed and Feed data found on page 305

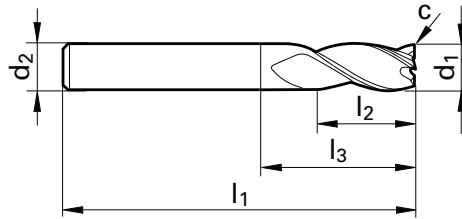

d1 h10	d2 h6	l1	l2	l3	c	No. of Flutes	Code no.	EDP Number	
mm	mm	mm	mm	mm	mm x 45°				
2.000	2.000	32.00	6.00	8.00	0.02	3	2.000	9032030020000	9037410020000
2.500	2.500	32.00	7.00	9.00	0.03	3	2.500	9032030025000	9037410025000
3.000	3.000	38.00	7.00	10.00	0.03	3	3.000	9032030030000	9037410030000
3.500	3.500	50.00	7.00	22.00	0.05	3	3.500	9032030035000	9037410035000
4.000	4.000	50.00	8.00	22.00	0.06	3	4.000	9032030040000	9037410040000
4.500	4.500	50.00	8.00	22.00	0.07	3	4.500	9032030045000	9037410045000
5.000	5.000	50.00	10.00	22.00	0.08	3	5.000	9032030050000	9037410050000
5.500	5.500	57.00	10.00	21.00	0.08	3	5.500	9032030055000	9037410055000
6.000	6.000	57.00	10.00	21.00	0.09	3	6.000	9032030060000	9037410060000
6.500	6.500	60.00	13.00	24.00	0.10	3	6.500	9032030065000	9037410065000
7.000	7.000	60.00	13.00	24.00	0.11	3	7.000	9032030070000	9037410070000
7.500	7.500	63.00	16.00	27.00	0.11	3	7.500	9032030075000	9037410075000
8.000	8.000	63.00	16.00	27.00	0.12	3	8.000	9032030080000	9037410080000
8.500	8.500	67.00	16.00	27.00	0.13	3	8.500	9032030085000	9037410085000
9.000	9.000	67.00	16.00	27.00	0.14	3	9.000	9032030090000	9037410090000
9.500	9.500	72.00	19.00	32.00	0.14	3	9.500	9032030095000	9037410095000
10.000	10.000	72.00	19.00	32.00	0.15	3	10.000	9032030100000	9037410100000
11.000	11.000	83.00	22.00	38.00	0.17	3	11.000	9032030110000	9037410110000
12.000	12.000	83.00	22.00	38.00	0.18	3	12.000	9032030120000	9037410120000
13.000	13.000	83.00	22.00	38.00	0.20	3	13.000	9032030130000	9037410130000
14.000	14.000	83.00	22.00	38.00	0.21	3	14.000	9032030140000	9037410140000
15.000	15.000	92.00	26.00	44.00	0.23	3	15.000	9032030150000	9037410150000
16.000	16.000	92.00	26.00	44.00	0.19	3	16.000	9032030160000	9037410160000
18.000	18.000	92.00	26.00	44.00	0.22	3	18.000	9032030180000	9037410180000
20.000	20.000	104.00	32.00	54.00	0.24	3	20.000	9032030200000	9037410200000



# ALUMI-TECH GA 200 A

The specialist for  
machining aluminium

This innovative tool was developed specifically for the machining of integrated aluminum components and is suitable for roughing and slot milling as well as finishing operations.

**Special features:**

- radial coolant exit (64° angle) for optimal chip evacuation (series #3367)
- radius geometry with continuous helix-radius-correction
- reduced neck ground for collision reduction (in certain series)



GA 200 A - Gühring series 3174

Seamless radius area provides high form and contour accuracy

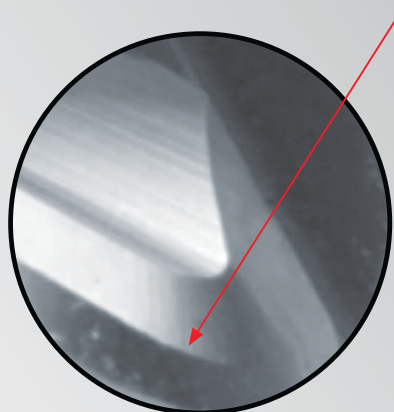

# Alumi-Tech GA200 A (2-flute) - Metric - Stub Length

## center cutting

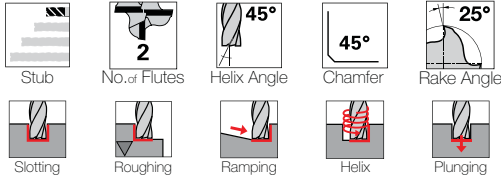

Tool material	Solid Carbide	
Surface finish	bright	bright
Series	3310	3126

Application group	Material examples	Ideal for
P	Steel	—
M	Stainless steel	—
K	Cast iron	—
N	Aluminum	●
S	Ni / Ti alloys	—
H	Hardened steel	—

●=Optimal ○=Secondary

Speed and Feed data found on page 305

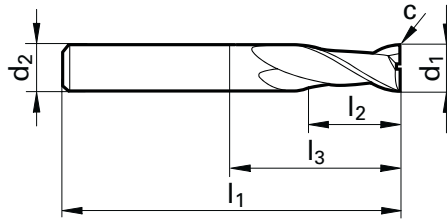

d1 e8	d2 h6	l1	l2	l3	c	No. of Flutes	Code no.	EDP Number	
mm	mm	mm	mm	mm	mm x 45°				
3.000	6.000	50.00	4.00	7.90	0.03	2	3.000	9033100030000	9031260030000
4.000	6.000	54.00	5.00	8.90	0.03	2	4.000	9033100040000	9031260040000
5.000	6.000	54.00	6.00	11.40	0.03	2	5.000	9033100050000	9031260050000
6.000	6.000	54.00	7.00	18.00	0.03	2	6.000	9033100060000	9031260060000
8.000	8.000	58.00	9.00	22.00	0.05	2	8.000	9033100080000	9031260080000
10.000	10.000	66.00	11.00	26.00	0.05	2	10.000	9033100100000	9031260100000
12.000	12.000	73.00	12.00	28.00	0.10	2	12.000	9033100120000	9031260120000
14.000	14.000	75.00	14.00	30.00	0.10	2	14.000	9033100140000	9031260140000
16.000	16.000	82.00	16.00	34.00	0.10	2	16.000	9033100160000	9031260160000
18.000	18.000	84.00	18.00	36.00	0.10	2	18.000	9033100180000	9031260180000
20.000	20.000	92.00	20.00	42.00	0.10	2	20.000	9033100200000	9031260200000

# Alumi-Tech GA200 A (2-flute) - Inch - Standard Length

## center cutting

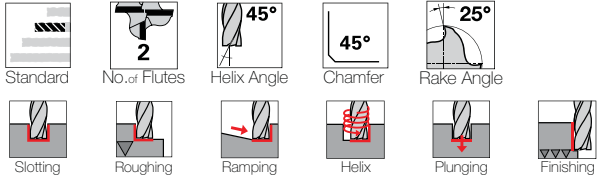

Tool material	<b>Solid Carbide</b>	<b>Solid Carbide</b>
Surface finish	bright	Super-A™
Series	<b>3174</b>	<b>3874</b>

Application group	Material examples	Ideal for
P	Steel	—
M	Stainless steel	—
K	Cast iron	—
N	Aluminum	●
S	Ni / Ti alloys	—
H	Hardened steel	—

●=Optimal ○=Secondary

Speed and Feed data found on page 293

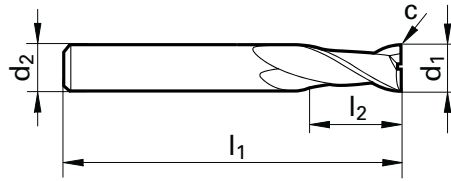

d1 h10	d2 h6	l1	l2	Chamfer	No. of Flutes	Code no.	EDP Number	
inch	inch	inch	inch	inch				
1/8	1/8	1 1/2	7/16	0.001	2	3.170	9031740031700	9038740031700
3/16	3/16	2	9/16	0.001	2	4.760	9031740047600	9038740047600
1/4	1/4	2 1/2	3/4	0.002	2	6.350	9031740063500	9038740063500
5/16	5/16	2 1/2	13/16	0.002	2	7.940	9031740079400	9038740079400
3/8	3/8	2 1/2	7/8	0.002	2	9.520	9031740095200	9038740095200
7/16	7/16	2 3/4	1	0.004	2	11.110	9031740111100	9038740111100
1/2	1/2	3	1	0.004	2	12.700	9031740127000	9038740127000
9/16	9/16	3 1/2	1 1/8	0.004	2	14.290	9031740142900	9038740142900
5/8	5/8	3 1/2	1 1/4	0.004	2	15.870	9031740158700	9038740158700
3/4	3/4	4	1 1/2	0.004	2	19.050	9031740190500	9038740190500
1	1	4	1 3/4	0.008	2	25.400	9031740254000	9038740254000

# Alumi-Tech GA200 A (2-flute) - Metric - Standard Length

## center cutting

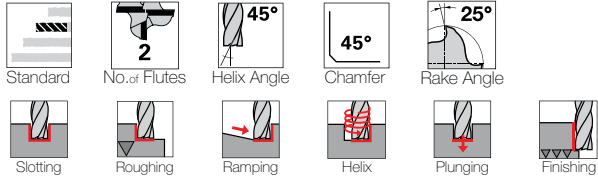

Tool material: **Solid Carbide**  
 Surface finish: bright

Series	<b>3309</b>	<b>3059</b>
--------	-------------	-------------

Application group	Material examples	Ideal for
<b>P</b>	Steel	—
<b>M</b>	Stainless steel	—
<b>K</b>	Cast iron	—
<b>N</b>	Aluminum	●
<b>S</b>	Ni / Ti alloys	—
<b>H</b>	Hardened steel	—

● = Optimal    ○ = Secondary

Speed and Feed data found on page 305

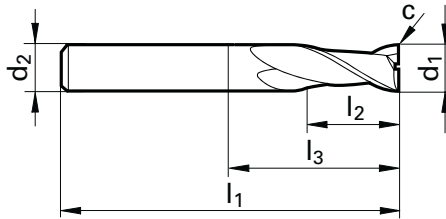

d1 e8	d2 h6	l1	l2	l3	c	No. of Flutes	Code no.	EDP Number	
mm	mm	mm	mm	mm	mm x 45°				
3.000	6.000	57.00	7.00	10.90	0.03	2	3.000	9033090030000	9030590030000
4.000	6.000	57.00	8.00	11.90	0.03	2	4.000	9033090040000	9030590040000
5.000	6.000	57.00	10.00	15.40	0.03	2	5.000	9033090050000	9030590050000
6.000	6.000	57.00	10.00	21.00	0.03	2	6.000	9033090060000	9030590060000
8.000	8.000	63.00	16.00	27.00	0.05	2	8.000	9033090080000	9030590080000
10.000	10.000	72.00	19.00	32.00	0.05	2	10.000	9033090100000	9030590100000
12.000	12.000	83.00	22.00	38.00	0.10	2	12.000	9033090120000	9030590120000
14.000	14.000	83.00	22.00	38.00	0.10	2	14.000	9033090140000	9030590140000
16.000	16.000	92.00	26.00	44.00	0.10	2	16.000	9033090160000	9030590160000
18.000	18.000	92.00	26.00	44.00	0.10	2	18.000	9033090180000	9030590180000
20.000	20.000	104.00	32.00	54.00	0.10	2	20.000	9033090200000	9030590200000

# Alumi-Tech GA200 A (2-flute) - Inch - Long Length

## center cutting

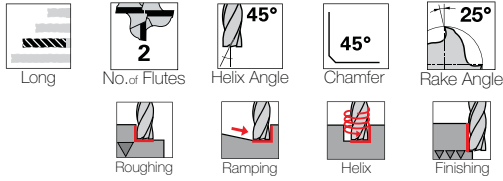

Tool material

**Solid Carbide**

**Solid Carbide**

Surface finish

bright

Super-A™

Series

**3175**

**3875**

Application group	Material examples	Ideal for
<b>P</b>	Steel	—
<b>M</b>	Stainless steel	—
<b>K</b>	Cast iron	—
<b>N</b>	Aluminum	●
<b>S</b>	Ni / Ti alloys	—
<b>H</b>	Hardened steel	—

●=Optimal    ○=Secondary

Speed and Feed data found on page 293

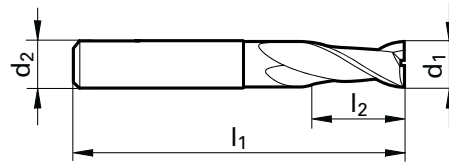

d1 h10	d2 h6	l1	l2	Chamfer	No. of Flutes	Code no.	EDP Number	
inch	inch	inch	inch	inch				
1/4	1/4	3	1 1/8	0.002	2	6.350	9031750063500	9038750063500
3/8	3/8	3	1 1/8	0.002	2	9.520	9031750095200	9038750095200
1/2	1/2	4 1/2	2	0.004	2	12.700	9031750127000	9038750127000
5/8	5/8	5	2 1/4	0.004	2	15.870	9031750158700	9038750158700

# Alumi-Tech GA200 A (2-flute) - Metric - XL Length

## center cutting



XL Long



No. of Flutes



45°



45°



25°



Slotting



Roughing



Ramping



Helix



Plunging



Finishing

Tool material

Surface finish

Series



**Solid Carbide**

bright

**3358**

Application group	Material examples	Ideal for
P	Steel	—
M	Stainless steel	—
K	Cast iron	—
N	Aluminum	●
S	Ni / Ti alloys	—
H	Hardened steel	—

●=Optimal ○=Secondary

Speed and Feed data found on page 305

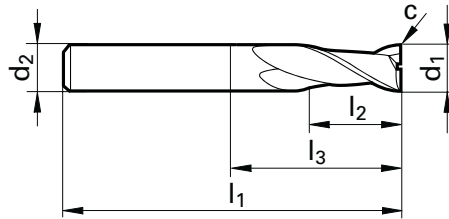

d1 h10	d2 h6	l1	l2	l3	c	No. of Flutes	Code no.	EDP Number
mm	mm	mm	mm	mm	mm x 45°			
5.000	5.000	75.00	30.00	47.00	0.03	2	5.000	9033580050000
6.000	6.000	75.00	30.00	39.00	0.03	2	6.000	9033580060000
8.000	8.000	100.00	40.00	64.00	0.05	2	8.000	9033580080000
10.000	10.000	100.00	40.00	60.00	0.05	2	10.000	9033580100000
12.000	12.000	150.00	45.00	105.00	0.10	2	12.000	9033580120000
16.000	16.000	150.00	65.00	102.00	0.10	2	16.000	9033580160000

# Alumi-Tech GA200 A (3-flute) - Metric - Standard Lgth w/Coolant



## center cutting

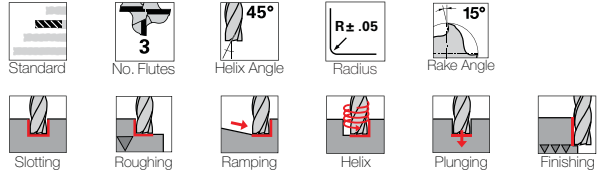

Tool material

**Solid Carbide**

Surface finish

bright

Series

**3367**

Application group	Material examples	Ideal for
<b>P</b>	Steel	—
<b>M</b>	Stainless steel	—
<b>K</b>	Cast iron	—
<b>N</b>	Aluminum	●
<b>S</b>	Ni / Ti alloys	—
<b>H</b>	Hardened steel	—

●=Optimal ○=Secondary

Speed and Feed data found on page 305

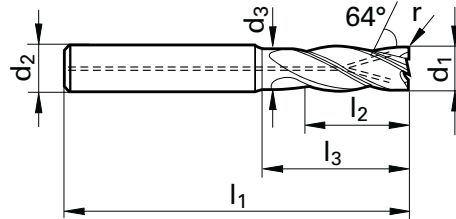

d1 h10	d2 h6	d3	l1	l2	l3	Corner Radius	No. of Flutes	Code no.	EDP Number
6.000	6.000	5.700	57.00	10.00	20.00	1.00	3	6.000	9033670060000
8.000	8.000	7.700	63.00	16.00	26.00	1.00	3	8.000	9033670080000
10.000	10.000	9.500	72.00	19.00	30.00	1.50	3	10.000	9033670100000
12.000	12.000	11.500	83.00	22.00	36.00	1.50	3	12.000	9033670120000
16.000	16.000	15.500	92.00	26.00	42.00	2.00	3	16.000	9033670160000
20.000	20.000	19.500	104.00	32.00	52.00	2.50	3	20.000	9033670200000
25.000	25.000	24.500	121.00	38.00	63.00	2.00	3	25.020	9033670250200

# Alumi-Tech GA200 A (3-flute) - Inch - XL Long Length

center cutting - reduced neck

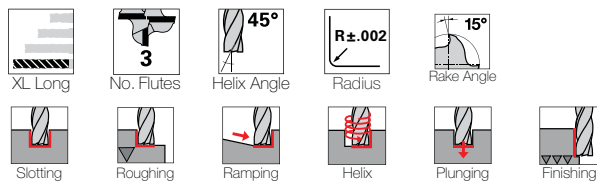

Tool material

Solid Carbide

Solid Carbide

Surface finish

FIREX®

Super-A™

Series

3177

3877

Application group	Material examples	Ideal for
P	Steel	—
M	Stainless steel	—
K	Cast iron	—
N	Aluminum	●
S	Ni / Ti alloys	—
H	Hardened steel	—

●=Optimal ○=Secondary

Speed and Feed data found on page 293

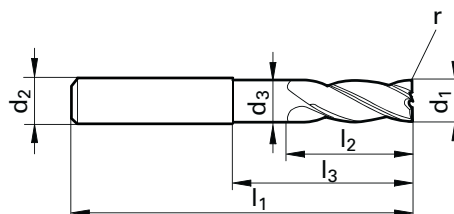

d1 h10	d2 h6	d3	l1	l2	l3	Corner Radius	No. of Flutes	Code no.	EDP Number	
1/4	1/4	0.238	3	3/8	1 1/2	0.010	3	6.350	9031770063500	9038770063500
5/16	5/16	0.301	3	7/16	1 1/2	0.013	3	7.940	9031770079400	9038770079400
3/8	3/8	0.363	3	9/16	1 1/2	0.015	3	9.520	9031770095200	9038770095200
1/2	1/2	0.480	4 1/2	3/4	2 3/4	0.020	3	12.700	9031770127000	9038770127000
5/8	5/8	0.605	5	7/8	3	0.025	3	15.870	9031770158700	9038770158700
3/4	3/4	0.730	5	1	3	0.030	3	19.050	9031770190500	9038770190500



# AERO-TECH GS 100 A

roughing cutters for aluminum,  
alloys and soft steel

GS 100 roughing cutters excel primarily thanks to their general purpose application possibilities enabling almost any combination of cutting depth (DOC) and cutting width (WOC). In comparison to roughing/finishing cutters with a flat knuckle-type geometry, the considerably lower power requirement ensures a reliable and economical machining process especially with less powerful machines.

Thanks to its round knuckle-type geometry with a staggered pitch angle (see illustration) the feed engagement is spread across the full length of the cutting edge even with less rigid workpiece clamping conditions or long tool neck lengths. In spite of a lower tooth feed rate compared to flat knuckle-types a high rate of metal removal is achieved.



GS 100 A: special geometry for aluminum:

- The 3-flute, 30° RH helix GS 100 A is suitable for the machining of aluminum, aluminum-alloys and other soft materials up to 700 N/mm<sup>2</sup>.

## Advantages at a glance:

- Reduced power requirement and cutting pressure
- Suitable for less powerful and less stable machines
- Suitable for less favorable workpiece and tool clamping conditions
- High metal removal rate thanks to the utilization of the complete cutting edge length

In comparison with conventional tools, GS 100 A roughing cutters with internal cooling excel with considerably longer tool life and higher feed rates as well as increased feed engagement widths and depths. Guhring milling cutters with radial coolant exits at 64° provide particular protection to the sensitive corners. The specifically aimed coolant exits completely prevent built-up edges and ensure complete chip evacuation, especially with deep pockets and channels.



GS 100 A · Guhring series 3364

GS 100 A · Guhring series 3184

# Rough-Tech ALU GS100 A (3-flute) - Inch - Standard Length

center cutting

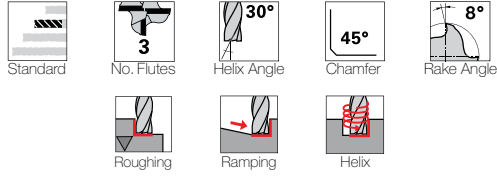

Tool material	<b>Solid Carbide</b>	<b>Solid Carbide</b>
Surface finish	bright	Super-A™
Series	<b>3184</b>	<b>3884</b>

Application group	Material examples	Ideal for
<b>P</b>	Steel	—
<b>M</b>	Stainless steel	—
<b>K</b>	Cast iron	—
<b>N</b>	Aluminum	●
<b>S</b>	Ni / Ti alloys	—
<b>H</b>	Hardened steel	—

●=Optimal ○=Secondary

Speed and Feed data found on page 294

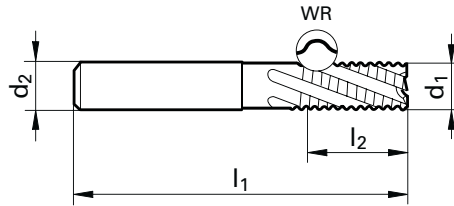

d1 h10	d2 h6	l1	l2	Chamfer	No. of Flutes	Code no.	EDP Number	
inch	inch	inch	inch	inch				
1/4	1/4	2 1/2	3/4	0.012	3	6.350	<b>9031840063500</b>	<b>9038840063500</b>
5/16	5/16	2 1/2	3/4	0.012	3	7.940	<b>9031840079400</b>	<b>9038840079400</b>
3/8	3/8	2 1/2	7/8	0.012	3	9.520	<b>9031840095200</b>	<b>9038840095200</b>
1/2	1/2	3	1	0.020	3	12.700	<b>9031840127000</b>	<b>9038840127000</b>
5/8	5/8	3 1/2	1 1/4	0.020	3	15.870	<b>9031840158700</b>	<b>9038840158700</b>
3/4	3/4	4	1 5/8	0.020	3	19.050	<b>9031840190500</b>	<b>9038840190500</b>
1	1	4	1 3/4	0.031	3	25.400	<b>9031840254000</b>	<b>9038840254000</b>

# Rough-Tech ALU GS100 A (3-flute) - Metric - Std Lgth - Coolant & non-Coolant

## center cutting



Standard



3



30°



45°



8°



Roughing



Ramping



Helix



HB



HB

Tool material

Solid Carbide

Surface finish

bright

bright

Series

3364

3127

Application group	Material examples	Ideal for
P	Steel	—
M	Stainless steel	—
K	Cast iron	—
N	Aluminum	●
S	Ni / Ti alloys	—
H	Hardened steel	—

●=Optimal ○=Secondary

Speed and Feed data found on page 306

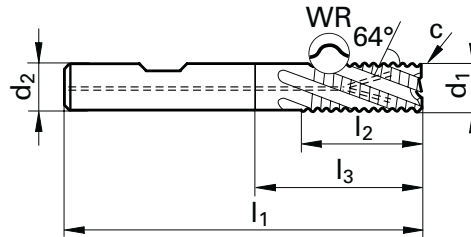

d1 h10	d2 h6	l1	l2	l3	c	No. of Flutes	Code no.	EDP Number	
mm	mm	mm	mm	mm	mm x 45°				
6.000	6.000	57.00	10.00	21.00	0.30	3	6.000	9033640060000	9031270060000
8.000	8.000	63.00	16.00	27.00	0.30	3	8.000	9033640080000	9031270080000
10.000	10.000	72.00	19.00	32.00	0.30	3	10.000	9033640100000	9031270100000
12.000	12.000	83.00	22.00	38.00	0.50	3	12.000	9033640120000	9031270120000
14.000	14.000	83.00	22.00	38.00	0.50	3	14.000		9031270140000
16.000	16.000	92.00	26.00	44.00	0.50	3	16.000	9033640160000	9031270160000
18.000	18.000	92.00	26.00	44.00	0.50	3	18.000		9031270180000
20.000	20.000	104.00	32.00	54.00	0.50	3	20.000	9033640200000	9031270200000
25.000	25.000	121.00	45.00	65.00	0.60	3	25.000		9031270250000

# ALUMINIUM

## NON-FERROUS METALS & PLASTICS



## APPLICATION EXAMPLE

### **RF 100 A, Ø 3/4"**

Slot milling in SAE 5083

$$a_e = 3/4" / a_p = .433"$$

$$v_c = 2470 \text{ SFM}$$

$$f_z = .0043 \text{ IPT}$$

$$v_f = 162 \text{ IPM}$$

$$\text{Metal removal rate } Q = 53 \text{ in}^3/\text{min}$$

### **RF 100 A, Ø 5/8"**

Slot milling in SAE 6082

$$a_e = .625" / a_p = .625"$$

$$v_c = 2180 \text{ SFM}$$

$$f_z = .0037 \text{ IPT}$$

$$v_f = 147 \text{ IPM}$$

$$\text{Metal removal rate } Q = 57 \text{ in}^3/\text{min}$$

# AERO-ROUGH RS 100 U/F

## roughing geometry for optimal efficiency

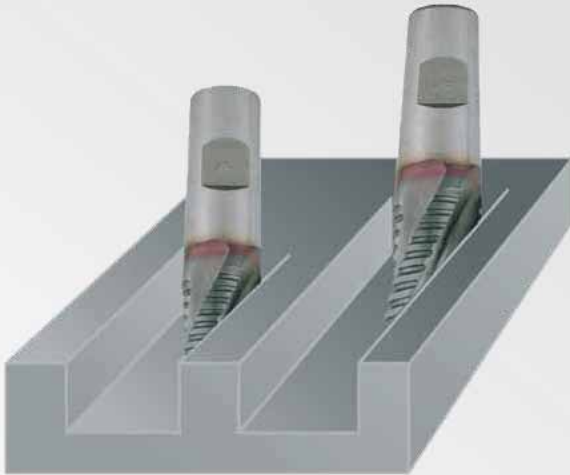

RS 100 high-performance roughing cutters benefit from a completely new roughing geometry, considerably reducing surface finish wear thanks to its unequal spacing. The result is a drastic increase in tool life compared to conventional round knuckle-type geometries and an improvement in the surface finish quality of the workpiece, so that in many applications finishing operations are unnecessary and the machining cost per workpiece is vastly reduced. In addition, the tool excels with a much reduced power requirement in comparison to tools without chip breaking geometry.

Two types of RS 100 high-performance roughing cutters are available: The 4-flute, 30° RH spiral RS 100 U is suitable for the machining of all standard steels. With a new 5 to 6 flute geometry and a spiral angle increased to 45°, RS 100 F possesses a considerably increased core diameter and is suitable for roughing/finishing operations with a width of cut up to 0.25 x D in all general purpose steels and tough materials.



RS 100 U/F · Guhring series 3890

RS 100 U/F · Guhring series 3887

### Advantages at a glance:

- Increased tool life in comparison to milling cutters with round knuckle-type teeth
- Increased feed rate thanks to new edge wear protection
- Improved workpiece surface finish
- Reduced power requirement compared to smooth cutting milling cutters

### Comparison overview:

Type	NR round knuckle-type	NF flat knuckle-type (old)	RS 100 U&F (new)
Perform. index	100%	65%	120%
Workpiece Surface finish	Ra = 9-10 µm 	Ra = 6-7 µm 	Ra = 2-3 µm 
Tool life index	100%	100%	140%

# AERO-ROUGH 48 RS100 U (4/5-Flute) - Inch - Standard Length

center cutting

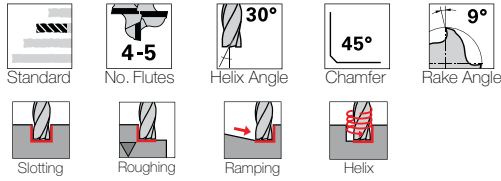

**F**

HA

Tool material

**Solid Carbide**

Surface finish

FIREX®

Series

**3097**

Application group	Material examples	Ideal for
<b>P</b>	Steel	●
<b>M</b>	Stainless steel	●
<b>K</b>	Cast iron	●
<b>N</b>	Aluminum	—
<b>S</b>	Ni / Ti alloys	○
<b>H</b>	Hardened steel	—

●=Optimal    ○=Secondary

Speed and Feed data found on page 291

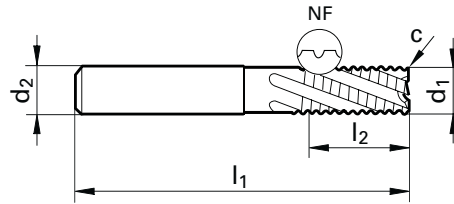

d1 h10	d2 h6	l1	l2	Chamfer	No. of Flutes	Code no.	EDP Number
inch	inch	inch	inch	inch			
1/4	1/4	2 1/2	3/4	0.012	4	6.350	9030970063500
5/16	5/16	2 1/2	13/16	0.012	4	7.940	9030970079400
3/8	3/8	2 1/2	7/8	0.012	4	9.520	9030970095200
1/2	1/2	3	1	0.020	4	12.700	9030970127000
5/8	5/8	3 1/2	1 1/4	0.020	4	15.870	9030970158700
3/4	3/4	4	1 5/8	0.020	4	19.050	9030970190500
1	1	4	1 3/4	0.031	5	25.400	9030970254000

# AERO-ROUGH 48 RS100 U (4/5-Flute) - Metric - Standard Length

## center cutting

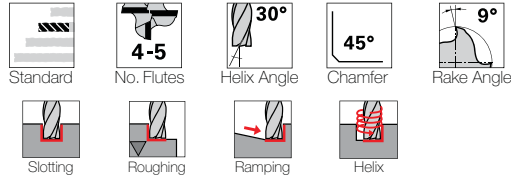

Tool material

**Solid Carbide**

Surface finish

FIREX®

FIREX®

Series

**3887**

**3888**

Application group	Material examples	Ideal for
P	Steel	●
M	Stainless steel	●
K	Cast iron	●
N	Aluminum	—
S	Ni / Ti alloys	○
H	Hardened steel	—

●=Optimal    ○=Secondary

Speed and Feed data found on page 291

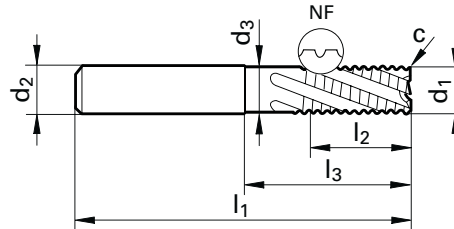

d1 h10	d2 h6	d3	l1	l2	l3	c	No. of Flutes	Code no.	EDP Number	
mm	mm	mm	mm	mm	mm	mm x 45°				
6.000	6.000	5.700	57.00	13.00	20.00	0.30	4	6.000	9038870060000	9038880060000
8.000	8.000	7.700	63.00	19.00	26.00	0.30	4	8.000	9038870080000	9038880080000
10.000	10.000	9.500	72.00	22.00	30.00	0.30	4	10.000	9038870100000	9038880100000
12.000	12.000	11.500	83.00	26.00	36.00	0.50	4	12.000	9038870120000	9038880120000
14.000	14.000	13.500	83.00	26.00	36.00	0.50	4	14.000	9038870140000	9038880140000
16.000	16.000	15.500	92.00	32.00	42.00	0.50	4	16.000	9038870160000	9038880160000
18.000	18.000	17.500	92.00	32.00	42.00	0.50	4	18.000	9038870180000	9038880180000
20.000	20.000	19.500	104.00	38.00	52.00	0.50	4	20.000	9038870200000	9038880200000
25.000	25.000	24.000	121.00	45.00	63.00	0.60	5	25.000	9038870250000	9038880250000

# AERO-ROUGH 56 RS100 F (5/6-Flute) - Inch - Standard Length

## center cutting

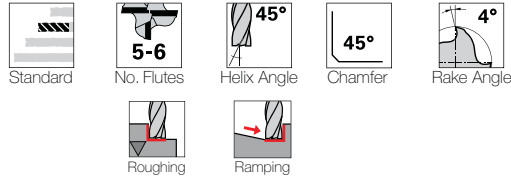

**F**

HA

Tool material

**Solid Carbide**

Surface finish

FIREX®

Series

**3098**

Application group	Material examples	Ideal for
<b>P</b>	Steel	●
<b>M</b>	Stainless steel	○
<b>K</b>	Cast iron	●
<b>N</b>	Aluminum	—
<b>S</b>	Ni / Ti alloys	●
<b>H</b>	Hardened steel	●

●=Optimal    ○=Secondary

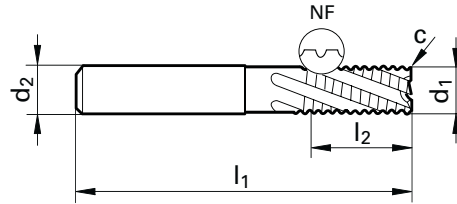

Speed and Feed data found on page 291

d1 h10	d2 h6	l1	l2	Chamfer	No. of Flutes	Code no.	EDP Number
inch	inch	inch	inch	inch			
1/4	1/4	2 1/2	3/4	0.012	5	6.350	9030980063500
5/16	5/16	2 1/2	13/16	0.012	5	7.940	9030980079400
3/8	3/8	2 1/2	7/8	0.012	5	9.520	9030980095200
1/2	1/2	3	1	0.020	5	12.700	9030980127000
5/8	5/8	3 1/2	1 1/4	0.020	6	15.870	9030980158700
3/4	3/4	4	1 5/8	0.020	6	19.050	9030980190500
1	1	4	1 3/4	0.031	6	25.400	9030980254000



# AERO-ROUGH 56 RS100 F (5/6-Flute) - Metric - Standard Length

## center cutting

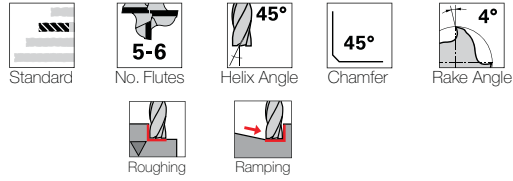

Tool material

**Solid Carbide**

Surface finish

FIREX®

FIREX®

Series

**3889**

**3890**

Application group	Material examples	Ideal for
P	Steel	●
M	Stainless steel	○
K	Cast iron	●
N	Aluminum	—
S	Ni / Ti alloys	●
H	Hardened steel	●

●=Optimal    ○=Secondary

Speed and Feed data found on page 303

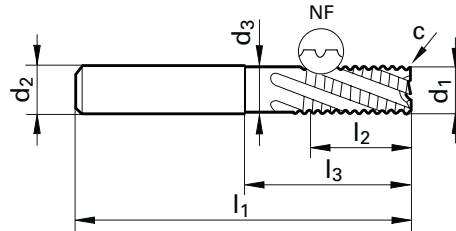

d1 h10	d2 h6	d3	l1	l2	l3	c	No. of Flutes	Code no.	EDP Number	
mm	mm	mm	mm	mm	mm	mm x 45°				
6.000	6.000	5.700	57.00	13.00	20.00	0.30	5	6.000	9038890060000	9038900060000
8.000	8.000	7.700	63.00	19.00	26.00	0.30	5	8.000	9038890080000	9038900080000
10.000	10.000	9.500	72.00	22.00	30.00	0.30	5	10.000	9038890100000	9038900100000
12.000	12.000	11.500	83.00	26.00	36.00	0.50	5	12.000	9038890120000	9038900120000
14.000	14.000	13.500	83.00	26.00	36.00	0.50	5	14.000	9038890140000	9038900140000
16.000	16.000	15.500	92.00	32.00	42.00	0.50	6	16.000	9038890160000	9038900160000
18.000	18.000	17.500	92.00	32.00	42.00	0.50	6	18.000	9038890180000	9038900180000
20.000	20.000	19.500	104.00	38.00	52.00	0.50	6	20.000	9038890200000	9038900200000
25.000	25.000	24.000	121.00	45.00	63.00	0.60	6	25.000	9038890250000	9038900250000

# Guhring GM 300 – HPC power clamp chucks

Well clamped is well milled!

## Summary of advantages

- extreme clamping force thanks to mechanical clamping transmission
- ideal combination with HPC end mills and thread milling cutters
- for immense speeds with HPC and HSC milling
- maximum rigidity

## |GÜHROJET|

Thanks to the securing pin in the PinLock clamping sleeve, tool pull-out is prevented when applied with standard milling tools utilizing HB shanks to DIN 6535 specifications. The combination of the HPC clamping technology, high concentricity, and the Guhrojet peripheral cooling feature allows us to achieve the perfect balance of high metal removal rates, longer tool life and improved surface finish.

## |PINLOCK|



# ROUGH-TECH GS 100 U

roughing cutters for  
materials < 48 HRC



GS 100 roughing cutters offer extensive general purpose application possibilities. These roughers have a unique round knuckle-type tooth profile which requires less HP than traditional flat knuckle-type end mills. The unique geometry also has a staggered pitch angle (see illustration), spreading the feed engagement across the full length of the cutting edge and allowing for a high rate of metal removal.

### **GS 100 U: special geometry for materials < 48 HRC**

- The 4-flute GS 100 U with its 30° RH spiral and fine knuckle-type teeth is suitable for the machining of all general steels up to 48 HRC, high-alloyed steels as well as titanium or chrome nickel alloys.

### **GS 100 H: special geometry for materials < 56 HRC**

- The GS 100 F 5- and 6-flute end mill has a 45° right hand spiral with the NF style knuckle design suitable for machining high tensile steels up to 56 HRC hardness.

### **Advantages at a glance:**

- reduced power requirement and cutting pressure
- suitable for less powerful and less stable machines
- suitable for less favorable workpiece and tool clamping conditions
- high metal removal rate thanks to the utilization of the complete cutting edge length

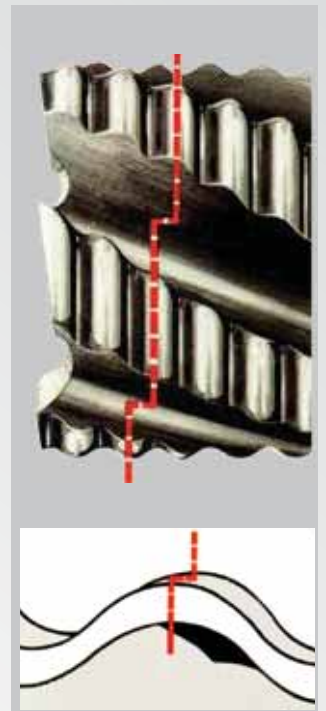

Guhring milling cutters with radial coolant exits at 64° (series #3365) provide particular protection to the sensitive corners. The specifically aimed coolant exits completely prevent built-up edges and ensure complete chip evacuation, especially with deep pockets and channels.

# ROUGH-TECH 48 GS100 U (4/5-Flute) - Inch - Standard Length

## center cutting

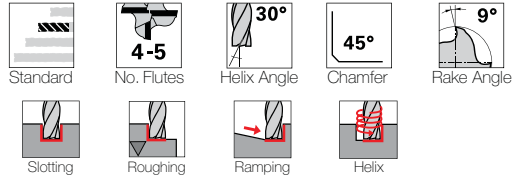

Tool material

**Solid Carbide**

Surface finish

bright

Series

**3186**

Application group	Material examples	Ideal for
<b>P</b>	Steel	○
<b>M</b>	Stainless steel	—
<b>K</b>	Cast iron	—
<b>N</b>	Aluminum	●
<b>S</b>	Ni / Ti alloys	—
<b>H</b>	Hardened steel	—

●=Optimal    ○=Secondary

Speed and Feed data found on page 294

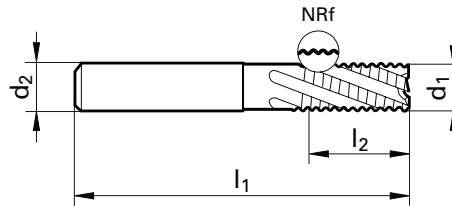

d1 h10	d2 h6	l1	l2	Chamfer	No. of Flutes	Code no.	EDP Number
inch	inch	inch	inch	inch			
1/4	1/4	2 1/2	3/4	0.012	4	6.350	9031860063500
5/16	5/16	2 1/2	3/4	0.012	4	7.940	9031860079400
3/8	3/8	2 1/2	7/8	0.012	4	9.520	9031860095200
1/2	1/2	3	1	0.020	4	12.700	9031860127000
5/8	5/8	3 1/2	1 1/4	0.020	4	15.870	9031860158700
3/4	3/4	4	1 5/8	0.020	4	19.050	9031860190500
1	1	4	1 3/4	0.031	5	25.400	9031860254000

# ROUGH-TECH 48 GS100 U (4/5-Flute) - Inch - Standard Length

## center cutting



Standard



No. Flutes



Helix Angle



Chamfer



Rake Angle



Slotting



Roughing



Ramping



Helix



Tool material

Solid Carbide

Solid Carbide

Surface finish

FIREX®

Super-A

Series

3188

3886

Application group	Material examples	Ideal for
P	Steel	●
M	Stainless steel	●
K	Cast iron	●
N	Aluminum	—
S	Ni / Ti alloys	●
H	Hardened steel	—

●=Optimal ○=Secondary

Speed and Feed data found on page 294

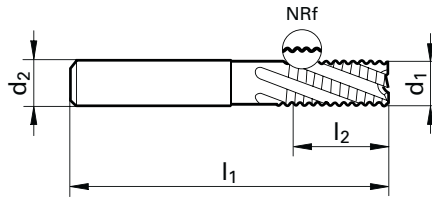

d1 h10	d2 h6	l1	l2	Chamfer	No. of Flutes	Code no.	EDP Number	
inch	inch	inch	inch	inch				
1/4	1/4	2 1/2	3/4	0.012	4	6.350	9031880063500	9038860063500
5/16	5/16	2 1/2	3/4	0.012	4	7.940	9031880079400	9038860079400
3/8	3/8	2 1/2	7/8	0.012	4	9.520	9031880095200	9038860095200
1/2	1/2	3	1	0.020	4	12.700	9031880127000	9038860127000
5/8	5/8	3 1/2	1 1/4	0.020	4	15.870	9031880158700	9038860158700
3/4	3/4	4	1 5/8	0.020	4	19.050	9031880190500	9038860190500
1	1	4	1 3/4	0.031	5	25.400	9031880254000	9038860254000

# ROUGH-TECH 48 GS100 U (4/5-Flute) - Metric - Standard Length

## center cutting

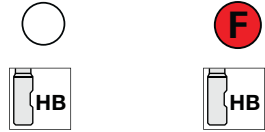
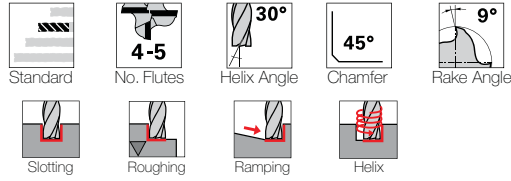

Tool material

Solid Carbide

Surface finish

bright

FIREX®

Series

3204

3723

Application group	Material examples	Ideal for
P	Steel	●
M	Stainless steel	●
K	Cast iron	●
N	Aluminum	○
S	Ni / Ti alloys	●
H	Hardened steel	—

●=Optimal ○=Secondary

Speed and Feed data found on page 306

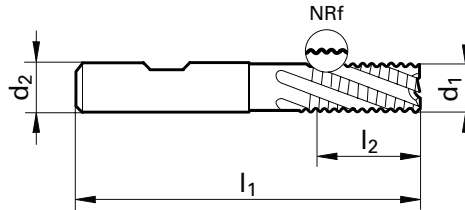

d1 h10	d2 h6	l1	l2	l3	c	No. of Flutes	Code no.	EDP Number	
mm	mm	mm	mm	mm	mm x 45°				
6.000	6.000	57.00	13.00	21.00	0.30	4	6.000	9032040060000	9037230060000
8.000	8.000	63.00	19.00	27.00	0.30	4	8.000	9032040080000	9037230080000
10.000	10.000	72.00	22.00	32.00	0.30	4	10.000	9032040100000	9037230100000
12.000	12.000	83.00	26.00	38.00	0.50	4	12.000	9032040120000	9037230120000
14.000	14.000	83.00	26.00	38.00	0.50	4	14.000	9032040140000	9037230140000
14.000	16.000	92.00	32.00	43.00	0.50	4	14.001	9032040140010	9037230140010
16.000	16.000	92.00	32.00	44.00	0.50	4	16.000	9032040160000	9037230160000
18.000	18.000	92.00	32.00	44.00	0.50	4	18.000	9032040180000	9037230180000
18.000	20.000	104.00	38.00	53.00	0.50	4	18.001	9032040180010	9037230180010
20.000	20.000	104.00	38.00	54.00	0.50	4	20.000	9032040200000	9037230200000
25.000	25.000	121.00	45.00	65.00	0.60	5	25.000	9032040250000	9037230250000

# ROUGH-TECH 48 GS100 U (4-Flute) - Metric - Std. Length with Coolant



## center cutting

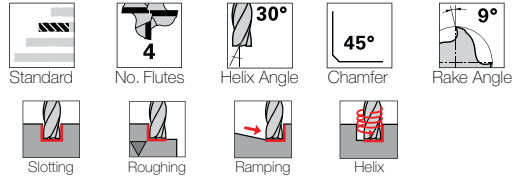

**F**

**HB**

Tool material

Surface finish

**FIREX®**

Series

**3365**

Application group	Material examples	Ideal for
<b>P</b>	Steel	●
<b>M</b>	Stainless steel	●
<b>K</b>	Cast iron	●
<b>N</b>	Aluminum	—
<b>S</b>	Ni / Ti alloys	●
<b>H</b>	Hardened steel	—

●=Optimal   ○=Secondary

Speed and Feed data found on page 306

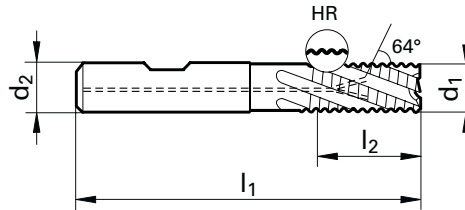

d1 h10	d2 h6	l1	l2	l3	c	No. of Flutes	Code no.	EDP Number
mm	mm	mm	mm	mm	mm x 45°			
6.000	6.000	57.00	13.00	21.00	0.30	4	6.000	9033650060000
8.000	8.000	63.00	19.00	27.00	0.30	4	8.000	9033650080000
10.000	10.000	72.00	22.00	32.00	0.30	4	10.000	9033650100000
12.000	12.000	83.00	26.00	38.00	0.50	4	12.000	9033650120000
16.000	16.000	92.00	32.00	44.00	0.50	4	16.000	9033650160000
20.000	20.000	104.00	38.00	54.00	0.50	4	20.000	9033650200000

# ROUGH-TECH GS 100 H

roughing cutters for  
materials < 54 HRC

GS 100 roughing cutters excel primarily thanks to their general purpose application possibilities enabling almost any combination of cutting depth (DOC) and cutting width (WOC). In comparison to roughing/finishing cutters with a flat knuckle-type geometry, the considerably lower power requirement ensures a reliable and economical machining process especially with less powerful machines.



## **GS 100 H: special geometry for materials < 54 HRC:**

GS 100 H excels in the machining of difficult-to-machine materials over 1000 N/mm<sup>2</sup>, cast iron and grey cast iron as well as hardened materials up to approximately 52 to 54 HRC thanks to its 20° helix and its small rake angle.

GS 100 H · Guhring series 3189

### **Advantages at a glance:**

- Reduced power requirement and cutting pressure
- Suitable for less powerful and less stable machines
- Suitable for less favorable workpiece and tool clamping conditions
- High metal removal rate thanks to the utilization of the complete cutting edge length



# ROUGH-TECH 56 GS100 H (4-Flute) - Inch - Standard Length

## center cutting

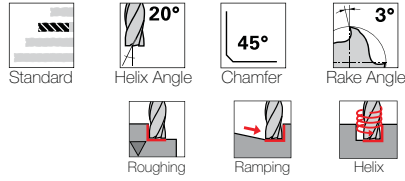

**F**



Tool material

**Solid Carbide**

Surface finish

FIREX®

Series

**3189**

Application group	Material examples	Ideal for
<b>P</b>	Steel	●
<b>M</b>	Stainless steel	—
<b>K</b>	Cast iron	●
<b>N</b>	Aluminum	—
<b>S</b>	Ni / Ti alloys	●
<b>H</b>	Hardened steel	●

●=Optimal ○=Secondary

Speed and Feed data found on page 294

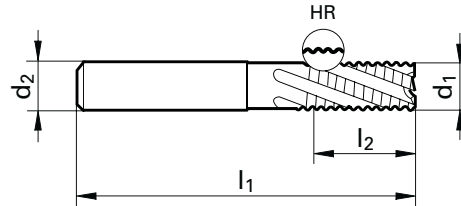

d1 h10	d2 h6	l1	l2	Chamfer	No. of Flutes	Code no.	EDP Number
inch	inch	inch	inch	inch			
1/4	1/4	2 1/2	3/4	0.012	4	6.350	9031890063500
5/16	5/16	2 1/2	3/4	0.012	4	7.940	9031890079400
3/8	3/8	2 1/2	7/8	0.012	4	9.520	9031890095200
1/2	1/2	3	1	0.020	4	12.700	9031890127000
5/8	5/8	3 1/2	1 1/4	0.020	4	15.870	9031890158700
3/4	3/4	4	1 5/8	0.020	4	19.050	9031890190500

# ROUGH-TECH 56 GS100 H (4-Flute) - Metric - Standard Length

## center cutting

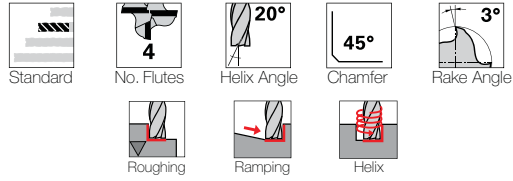

Tool material

**Solid Carbide**

Surface finish

nano-Si®

Series

**3682**

Application group	Material examples	Ideal for
<b>P</b>	Steel	●
<b>M</b>	Stainless steel	—
<b>K</b>	Cast iron	●
<b>N</b>	Aluminum	—
<b>S</b>	Ni / Ti alloys	●
<b>H</b>	Hardened steel	●

●=Optimal ○=Secondary

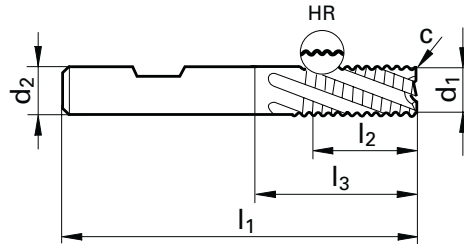

Speed and Feed data found on page 306

d1 h10	d2 h6	l1	l2	l3	c	No. of Flutes	Code no.	EDP Number
mm	mm	mm	mm	mm	mm x 45°			
6.000	6.000	57.00	13.00	21.00	0.30	4	6.000	9036820060000
8.000	8.000	63.00	19.00	27.00	0.30	4	8.000	9036820080000
10.000	10.000	72.00	22.00	32.00	0.30	4	10.000	9036820100000
12.000	12.000	83.00	26.00	38.00	0.50	4	12.000	9036820120000
16.000	16.000	92.00	32.00	44.00	0.50	4	16.000	9036820160000
20.000	20.000	104.00	38.00	54.00	0.50	4	20.000	9036820200000

# ROUGH-TECH 56 GS100 H (4-Flute) - Inch - Long Length - Necked

center cutting

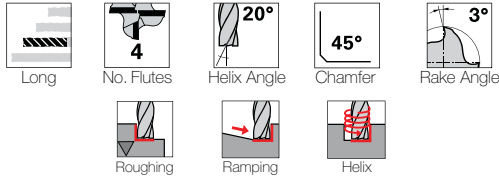

**F**

HA

Tool material

**Solid Carbide**

Surface finish

FIREX®

Series

**3190**

Application group	Material examples	Ideal for
<b>P</b>	Steel	●
<b>M</b>	Stainless steel	—
<b>K</b>	Cast iron	●
<b>N</b>	Aluminum	—
<b>S</b>	Ni / Ti alloys	●
<b>H</b>	Hardened steel	●

●=Optimal ○=Secondary

Speed and Feed data found on page 294

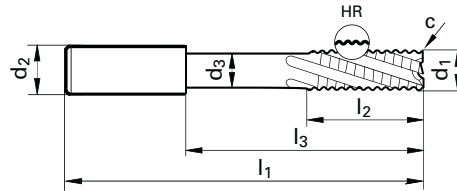

d1 h10	d2 h6	d3	l1	l2	l3	Chamfer	No. of Flutes	Code no.	EDP Number
inch	inch	inch	inch	inch	inch	inch			
1/4	1/4	0.238	3	3/4	1 1/2	0.012	4	6.350	9031900063500
5/16	5/16	0.301	3	7/8	1 1/2	0.012	4	7.940	9031900079400
3/8	3/8	0.363	3	7/8	1 1/2	0.012	4	9.520	9031900095200
1/2	1/2	0.480	4 1/2	1	2 3/4	0.020	4	12.700	9031900127000
5/8	5/8	0.605	5	1 1/4	3	0.020	4	15.870	9031900158700
3/4	3/4	0.730	5	1 1/2	3	0.020	4	19.050	9031900190500

# GH 100 U

The Guhring GH 100 U end mills offer the ultimate prerequisite for a cost-efficient, optimal machining of general steels, high-alloyed steels, CrNi steels as well as stainless steels and titanium-alloys up to 50 HRC.

All GH 100 U end mills excel thanks to their micro-corner protection combined with a reinforced and corrected minor cutting edge. This design considerably reduces the wear at the cutting edges allowing a higher feed rate as well as improved tool life.



GH 100 U · Guhring series 3178

GH 100 U end mills (3-fluted) excel further thanks to their optimized flute geometry, achieving ultimate machining efficiency especially for slot milling and roughing operations. Paired with a very high spiral, optimal chip evacuation is achieved while reducing vibration. The advantages:

- **reduced wear**
- **high feed rates possible**
- **optimal chip evacuation**
- **can be applied for roughing and finishing**

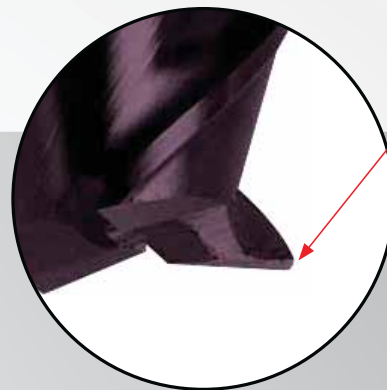

Micro-corner protection and corrected reinforced cutting edge = optimal stability

# FINISH-TECH 50 GH100 U (6/8/10-Flute) - Inch - Standard Length

## center cutting



Standard



No. Flutes



Helix Angle



Chamfer



Rake Angle



Finishing



HA



HA

Tool material

Solid Carbide

Solid Carbide

Surface finish

bright

FIREX®

Series

3178

3179

Application group	Material examples	Ideal for
P	Steel	●
M	Stainless steel	●
K	Cast iron	●
N	Aluminum	○
S	Ni / Ti alloys	●
H	Hardened steel	○

●=Optimal ○=Secondary

Speed and Feed data found on page 293

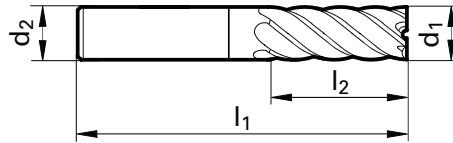

d1 h10	d2 h6	l1	l2	Chamfer	No. of Flutes	Code no.	EDP Number	EDP Number
inch	inch	inch	inch	inch				
1/4	1/4	2 1/2	3/4	0.004	6	6.350	9031780063500	9031790063500
5/16	5/16	2 1/2	7/8	0.004	6	7.940	9031780079400	9031790079400
3/8	3/8	2 1/2	7/8	0.004	6	9.520	9031780095200	9031790095200
1/2	1/2	3	1	0.006	6	12.700	9031780127000	9031790127000
5/8	5/8	3 1/2	1 1/4	0.006	6	15.870	9031780158700	9031790158700
3/4	3/4	4	1 1/2	0.006	8	19.050	9031780190500	9031790190500
1	1	4	1 1/2	0.012	10	25.400	9031780254000	9031790254000

# FINISH-TECH 50 GH100 U (6-Flute) - Inch - Standard Length

center cutting



Standard



No. Flutes



Helix Angle



Chamfer



Rake Angle



Finishing

Y



Tool material

Solid Carbide

Surface finish

nano-Si®

Series

3084

Application group	Material examples	Ideal for
P	Steel	●
M	Stainless steel	●
K	Cast iron	●
N	Aluminum	—
S	Ni / Ti alloys	●
H	Hardened steel	○

●=Optimal ○=Secondary

Speed and Feed data found on page 293

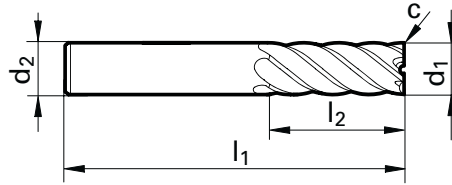

d1 h10	d2 h6	l1	l2	Chamfer	No. of Flutes	Code no.	EDP Number
inch	inch	inch	inch	inch			
1/4	1/4	2 1/2	3/4	0.004	6	6.350	9030840063500
5/16	5/16	2 1/2	7/8	0.004	6	7.940	9030840079400
3/8	3/8	2 1/2	7/8	0.004	6	9.520	9030840095200
1/2	1/2	3	1	0.006	6	12.700	9030840127000
5/8	5/8	3 1/2	1 1/4	0.006	6	15.870	9030840158700
3/4	3/4	4	1 1/2	0.006	8	19.050	9030840190500

# FINISH-TECH 50 GH100 U (6/8/10-Flute) - Inch - Std Length - Corner Radius

center cutting



Standard



No. Flutes



Helix Angle



Radius



Rake Angle



Finishing

F



HA

Tool material

Solid Carbide

Surface finish

FIREX®

Series

3091

Application group	Material examples	Ideal for
P	Steel	●
M	Stainless steel	●
K	Cast iron	●
N	Aluminum	--
S	Ni / Ti alloys	●
H	Hardened steel	○

●=Optimal ○=Secondary

Speed and Feed data found on page 293

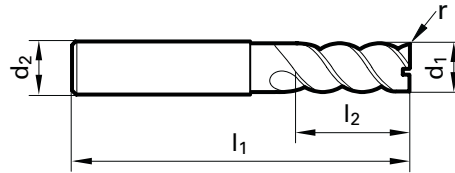

d1 h10	d2 h6	l1	l2	Radius	No. of Flutes	Code no.	EDP Number
inch	inch	inch	inch	inch			
1/4	1/4	2 1/2	3/4	0.015	6	6.352	9030910063520
1/4	1/4	2 1/2	3/4	0.031	6	6.354	9030910063540
1/4	1/4	2 1/2	3/4	0.062	6	6.356	9030910063560
5/16	5/16	2 1/2	13/16	0.015	6	7.942	9030910079420
5/16	5/16	2 1/2	13/16	0.031	6	7.944	9030910079440
5/16	5/16	2 1/2	13/16	0.062	6	7.946	9030910079460
3/8	3/8	2 1/2	1	0.015	6	9.522	9030910095220
3/8	3/8	2 1/2	1	0.031	6	9.524	9030910095240
3/8	3/8	2 1/2	1	0.062	6	9.526	9030910095260
1/2	1/2	3	1	0.015	6	12.702	9030910127020
1/2	1/2	3	1	0.031	6	12.704	9030910127040
1/2	1/2	3	1	0.062	6	12.706	9030910127060
1/2	1/2	3	1	0.09	6	12.707	9030910127070
5/8	5/8	3 1/2	1 1/4	0.031	6	15.874	9030910158740
5/8	5/8	3 1/2	1 1/4	0.062	6	15.876	9030910158760
5/8	5/8	3 1/2	1 1/4	0.09	6	15.877	9030910158770
3/4	3/4	4	1 1/2	0.031	8	19.054	9030910190540
3/4	3/4	4	1 1/2	0.062	8	19.056	9030910190560
3/4	3/4	4	1 1/2	0.09	8	19.057	9030910190570
3/4	3/4	4	1 1/2	0.125	8	19.059	9030910190590

# FINISH-TECH 50 GH100 U (6/8/10-Flute) - Metric - Standard Length

## center cutting



Standard



No. Flutes



Helix Angle



Chamfer



Rake Angle



Finishing



HA



HA

Tool material

Solid Carbide

Surface finish

bright

FIREX®

Series

3311

3689

Application group	Material examples	Ideal for
P	Steel	●
M	Stainless steel	●
K	Cast iron	●
N	Aluminum	○
S	Ni / Ti alloys	●
H	Hardened steel	○

●=Optimal ○=Secondary

Speed and Feed data found on page 305

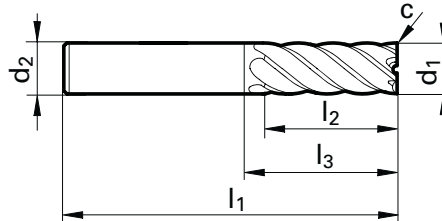

d1 h10	d2 h6	l1	l2	l3	c	No. of Flutes	Code no.	EDP Number	
mm	mm	mm	mm	mm	mm x 45°				
3.000	6.000	57.00	8.00	11.40	0.05	6	3.000	9033110030000	9036890030000
4.000	6.000	57.00	11.00	15.90	0.05	6	4.000	9033110040000	9036890040000
5.000	6.000	57.00	13.00	17.90	0.05	6	5.000	9033110050000	9036890050000
6.000	6.000	57.00	13.00	21.00	0.05	6	6.000	9033110060000	9036890060000
8.000	8.000	63.00	19.00	27.00	0.10	6	8.000	9033110080000	9036890080000
10.000	10.000	72.00	22.00	32.00	0.10	6	10.000	9033110100000	9036890100000
12.000	12.000	83.00	26.00	38.00	0.10	6	12.000	9033110120000	9036890120000
14.000	14.000	83.00	26.00	38.00	0.15	6	14.000	9033110140000	9036890140000
14.000	16.000	92.00	32.00	44.00	0.15	6	14.001	9033110140010	9036890140010
16.000	16.000	92.00	32.00	44.00	0.15	6	16.000	9033110160000	9036890160000
18.000	18.000	92.00	32.00	44.00	0.15	8	18.000	9033110180000	9036890180000
18.000	20.000	104.00	38.00	54.00	0.15	8	18.001	9033110180010	9036890180010
20.000	20.000	104.00	38.00	54.00	0.15	8	20.000	9033110200000	9036890200000
25.000	25.000	121.00	45.00	65.00	0.20	10	25.000	9033110250000	9036890250000



# FINISH-TECH 50 GH100 U (6/8/10-Flute) - Metric - Standard Length

## center cutting



Standard



No. Flutes



Helix Angle



Chamfer



Rake Angle



Finishing



Tool material

Solid Carbide

Solid Carbide

Surface finish

bright

FIREX®

Series

3019

3047

Application group	Material examples	Ideal for
P	Steel	●
M	Stainless steel	●
K	Cast iron	●
N	Aluminum	○
S	Ni / Ti alloys	●
H	Hardened steel	○

●=Optimal ○=Secondary

Speed and Feed data found on page 293

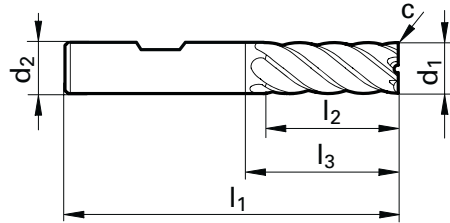

d1 h10	d2 h6	l1	l2	l3	c	No. of Flutes	Code no.	EDP Number	EDP Number
mm	mm	mm	mm	mm	mm x 45°				
6.000	6.000	57.00	13.00	21.00	0.05	6	6.000	9030190060000	9030470060000
8.000	8.000	63.00	19.00	27.00	0.10	6	8.000	9030190080000	9030470080000
10.000	10.000	72.00	22.00	32.00	0.10	6	10.000	9030190100000	9030470100000
12.000	12.000	83.00	26.00	38.00	0.10	6	12.000	9030190120000	9030470120000
14.000	14.000	83.00	26.00	38.00	0.15	6	14.000	9030190140000	9030470140000
16.000	16.000	92.00	32.00	44.00	0.15	6	16.000	9030190160000	9030470160000
18.000	18.000	92.00	32.00	44.00	0.15	8	18.000	9030190180000	9030470180000
20.000	20.000	104.00	38.00	54.00	0.15	8	20.000	9030190200000	9030470200000
25.000	25.000	121.00	45.00	65.00	0.20	10	25.000	9030190250000	9030470250000

# FINISH-TECH 50 GH100 U (6/8-flute) - Metric - Standard Length

## center cutting

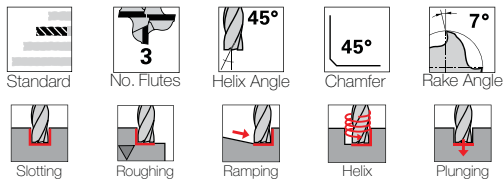

Tool material

Solid Carbide

Solid Carbide

Surface finish

bright

FIREX®

Series

3112

3563

Application group	Material examples	Ideal for
P	Steel	●
M	Stainless steel	●
K	Cast iron	●
N	Aluminum	○
S	Ni / Ti alloys	●
H	Hardened steel	○

●=Optimal    ○=Secondary

Speed and Feed data found on page 305

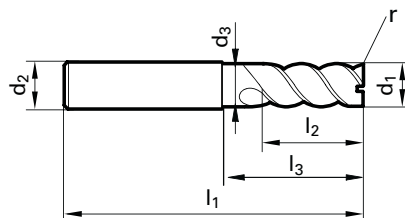

d1 h10	d2 h6	d3	l1	l2	l3	r	No. of Flutes	Code no.	EDP Number	
mm	mm	mm	mm	mm	mm	mm				
6.000	6.000	5.700	57.00	13.00	20.00	0.5	6	6.005	9031120060050	9035630060050
6.000	6.000	5.700	57.00	13.00	20.00	1.0	6	6.010	9031120060100	9035630060100
8.000	8.000	7.700	63.00	19.00	26.00	0.5	6	8.005	9031120080050	9035630080050
8.000	8.000	7.700	63.00	19.00	26.00	1.0	6	8.010	9031120080100	9035630080100
8.000	8.000	7.700	63.00	19.00	26.00	1.5	6	8.015	9031120080150	9035630080150
8.000	8.000	7.700	63.00	19.00	26.00	2.0	6	8.020	9031120080200	9035630080200
10.000	10.000	9.500	72.00	22.00	30.00	0.5	6	10.005	9031120100050	9035630100050
10.000	10.000	9.500	72.00	22.00	30.00	1.0	6	10.010	9031120100100	9035630100100
10.000	10.000	9.500	72.00	22.00	30.00	1.5	6	10.015	9031120100150	9035630100150
10.000	10.000	9.500	72.00	22.00	30.00	2.0	6	10.020	9031120100200	9035630100200
12.000	12.000	11.500	83.00	26.00	36.00	0.5	6	12.005	9031120120050	9035630120050
12.000	12.000	11.500	83.00	26.00	36.00	1.0	6	12.010	9031120120100	9035630120100
12.000	12.000	11.500	83.00	26.00	36.00	1.5	6	12.015	9031120120150	9035630120150
12.000	12.000	11.500	83.00	26.00	36.00	2.0	6	12.020	9031120120200	9035630120200
16.000	16.000	15.500	92.00	32.00	42.00	1.0	6	16.010	9031120160100	9035630160100
16.000	16.000	15.500	92.00	32.00	42.00	1.5	6	16.015	9031120160150	9035630160150
16.000	16.000	15.500	92.00	32.00	42.00	2.0	6	16.020	9031120160200	9035630160200
20.000	20.000	19.500	104.00	38.00	52.00	1.0	8	20.010	9031120200100	9035630200100
20.000	20.000	19.500	104.00	38.00	52.00	1.5	8	20.015	9031120200150	9035630200150
20.000	20.000	19.500	104.00	38.00	52.00	2.0	8	20.020	9031120200200	9035630200200

# FINISH-TECH 50 GH100 U (6/8/10-Flute) - Inch - Long Length

## center cutting



Tool material

Solid Carbide

Solid Carbide

Surface finish

bright

FIREX®

Series

3180

3181

Application group	Material examples	Ideal for
P	Steel	●
M	Stainless steel	●
K	Cast iron	●
N	Aluminum	○
S	Ni / Ti alloys	●
H	Hardened steel	○

●=Optimal ○=Secondary

Speed and Feed data found on page 293

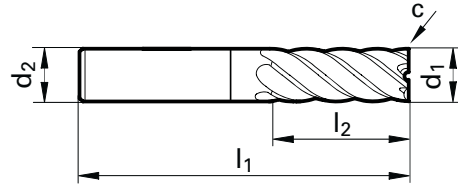

d1 h10	d2 h6	l1	l2	Chamfer	No. of Flutes	Code no.	EDP Number	EDP Number
inch	inch	inch	inch	inch				
1/4	1/4	3	1 1/8	0.004	6	6.350	9031800063500	9031810063500
5/16	5/16	3	1 1/8	0.004	6	7.940	9031800079400	9031810079400
3/8	3/8	3	1 1/8	0.004	6	9.520	9031800095200	9031810095200
1/2	1/2	4 1/2	2	0.006	6	12.700	9031800127000	9031810127000
5/8	5/8	5	2 1/4	0.006	6	15.870	9031800158700	9031810158700
3/4	3/4	5	2 1/4	0.006	8	19.050	9031800190500	9031810190500

# FINISH-TECH 50 GH100 U (6/8/10-Flute) - Metric - XL Long Length

center cutting



Tool material

Solid Carbide

Surface finish

bright

FIREX®

Series

3312

3691

Application group	Material examples	Ideal for
P	Steel	●
M	Stainless steel	●
K	Cast iron	●
N	Aluminum	○
S	Ni / Ti alloys	●
H	Hardened steel	○

●=Optimal ○=Secondary

Speed and Feed data found on page 305

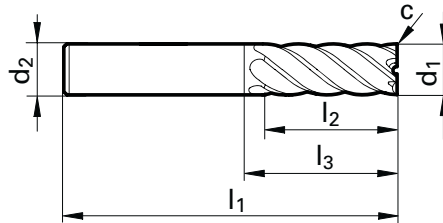

d1 h10	d2 h6	l1	l2	l3	c	No. of Flutes	Code no.	EDP Number	
mm	mm	mm	mm	mm	mm x 45°				
6.000	6.000	75.00	30.00	39.00	0.05	6	6.000	9033120060000	9036910060000
8.000	8.000	100.00	40.00	64.00	0.10	6	8.000	9033120080000	9036910080000
10.000	10.000	100.00	40.00	60.00	0.10	6	10.000	9033120100000	9036910100000
12.000	12.000	150.00	45.00	105.00	0.10	6	12.000	9033120120000	9036910120000
16.000	16.000	150.00	65.00	102.00	0.15	6	16.000	9033120160000	9036910160000
20.000	20.000	150.00	65.00	100.00	0.15	8	20.000	9033120200000	9036910200000
25.000	25.000	150.00	75.00	94.00	0.20	10	25.000	9033120250000	9036910250000

# FINISH-TECH 50 GH100 U (6/8/10-Flute) - Metric - XL Long Length

## center cutting



XL Long



No. Flutes



Helix Angle



Chamfer



Rake Angle



Finishing



HB



HB

Tool material

Solid Carbide

Surface finish

bright

FIREX®

Series

3313

3693

Application group	Material examples	Ideal for
P	Steel	●
M	Stainless steel	●
K	Cast iron	●
N	Aluminum	○
S	Ni / Ti alloys	●
H	Hardened steel	○

●=Optimal ○=Secondary

Speed and Feed data found on page 305

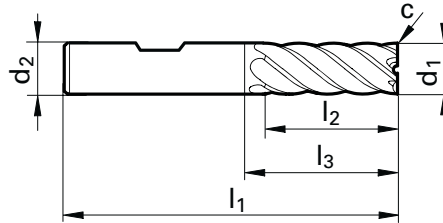

d1 h10	d2 h6	l1	l2	l3	c	No. of Flutes	Code no.	EDP Number	
mm	mm	mm	mm	mm	mm x 45°				
6.000	6.000	75.00	30.00	39.00	0.05	6	6.000	9033130060000	9036930060000
8.000	8.000	100.00	40.00	64.00	0.10	6	8.000	9033130080000	9036930080000
10.000	10.000	100.00	40.00	60.00	0.10	6	10.000	9033130100000	9036930100000
12.000	12.000	150.00	45.00	105.00	0.10	6	12.000	9033130120000	9036930120000
16.000	16.000	150.00	65.00	102.00	0.15	6	16.000	9033130160000	9036930160000
20.000	20.000	150.00	65.00	100.00	0.15	8	20.000	9033130200000	9036930200000
25.000	25.000	150.00	75.00	94.00	0.20	10	25.000	9033130250000	9036930250000

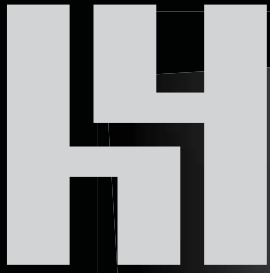

HOLLFELDER  
**GUHRING**  
CUTTING TOOLS

# HPC FACE MILLS

[www.hollfelder-cuttingtools.de](http://www.hollfelder-cuttingtools.de)



# FINISH-TECH GH 100 H

high- performance end mills  
for hard milling and superfine finishing

Guhring's hard milling cutters optimally satisfy the requirements for time- and cost-saving machining of hardened workpieces. Different geometries as well as the carbide grade with its high hardness and toughness are optimally adapted for the various milling operations.

Subsequently, Guhring's hard milling cutters achieve highest contour accuracy for cutting depths up to 4xD. Furthermore, milling cutters with full or corner radii are especially suitable for roughing or finishing operations in 3D HSC machining of forms and forging dies.

## Advantages at a glance:

- Application up to 62 HRC
- Superior tool rigidity
- High contour accuracy of radii
- Excellent surface finish

GH 100 H · Guhring series 3183

GH 100 H · Guhring series 3182

Micro-corner protection and corrected reinforced cutting edge = optimal stability

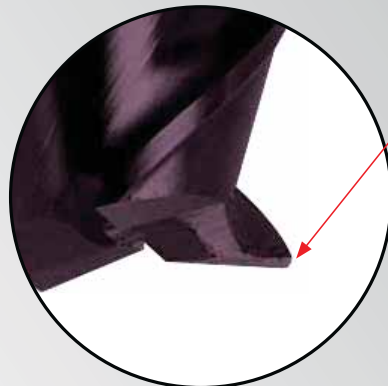

# FINISH-TECH 62 GH100 H (6/8-Flute) - Inch - Standard Length

## center cutting

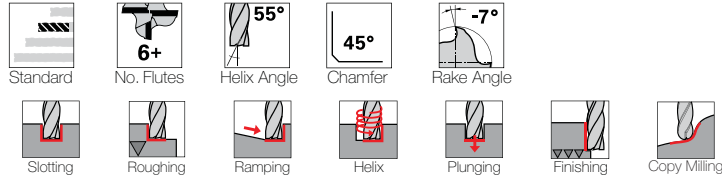

Tool material

**Solid Carbide**

Surface finish

nano-Si®

Series

**3182**

Application group	Material examples	Ideal for
<b>P</b>	Steel	—
<b>M</b>	Stainless steel	—
<b>K</b>	Cast iron	○
<b>N</b>	Aluminum	—
<b>S</b>	Ni / Ti alloys	—
<b>H</b>	Hardened steel	●

●=Optimal    ○=Secondary

Speed and Feed data found on page 293

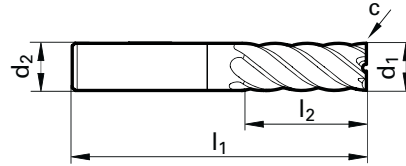

d1 h10	d2 h6	l1	l2	Chamfer	No. of Flutes	Code no.	EDP Number
inch	inch	inch	inch	inch			
1/4	1/4	2 1/2	3/4	0.004	6	6.350	9031820063500
5/16	5/16	2 1/2	7/8	0.004	6	7.940	9031820079400
3/8	3/8	2 1/2	7/8	0.004	6	9.520	9031820095200
1/2	1/2	3	1	0.006	6	12.700	9031820127000
5/8	5/8	3 1/2	1 1/4	0.006	6	15.870	9031820158700
3/4	3/4	4	1 1/2	0.006	8	19.050	9031820190500



# FINISH-TECH 62 GH100 H (6/8-Flute) - Metric - Standard Length

## center cutting



Standard



No. Flutes



Helix Angle



Chamfer



Rake Angle



Finishing



Tool material

**Solid Carbide**

Surface finish

nano-Si®

Series

**3715**

Application group	Material examples	Ideal for
P	Steel	—
M	Stainless steel	—
K	Cast iron	○
N	Aluminum	—
S	Ni / Ti alloys	—
H	Hardened steel	●

●=Optimal    ○=Secondary

Speed and Feed data found on page 305

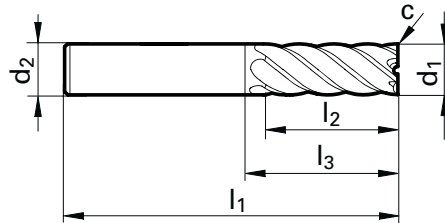

d1 h10	d2 h6	l1	l2	l3	c	No. of Flutes	Code no.	EDP Number
mm	mm	mm	mm	mm	mm x 45°			
3.000	6.000	57.00	8.00	11.40	0.05	6	3.000	9037150030000
4.000	6.000	57.00	11.00	15.90	0.05	6	4.000	9037150040000
5.000	6.000	57.00	13.00	17.90	0.05	6	5.000	9037150050000
6.000	6.000	57.00	13.00	21.00	0.05	6	6.000	9037150060000
8.000	8.000	63.00	19.00	27.00	0.10	6	8.000	9037150080000
10.000	10.000	72.00	22.00	32.00	0.10	6	10.000	9037150100000
12.000	12.000	83.00	26.00	38.00	0.10	6	12.000	9037150120000
14.000	14.000	83.00	26.00	38.00	0.15	6	14.000	9037150140000
14.000	16.000	92.00	32.00	43.00	0.15	6	14.001	9037150140010
16.000	16.000	92.00	32.00	44.00	0.15	6	16.000	9037150160000
18.000	18.000	92.00	32.00	44.00	0.15	8	18.000	9037150180000
18.000	20.000	104.00	38.00	53.00	0.15	8	18.001	9037150180010
20.000	20.000	104.00	38.00	54.00	0.15	8	20.000	9037150200000

# FINISH-TECH 62 GH100 H (6/8-Flute) - Inch - Long Length - Necked

center cutting



Tool material

**Solid Carbide**

Surface finish

nano-Si®

Series

**3183**

Application group	Material examples	Ideal for
<b>P</b>	Steel	—
<b>M</b>	Stainless steel	—
<b>K</b>	Cast iron	○
<b>N</b>	Aluminum	—
<b>S</b>	Ni / Ti alloys	—
<b>H</b>	Hardened steel	●

●=Optimal    ○=Secondary

Speed and Feed data found on page 293

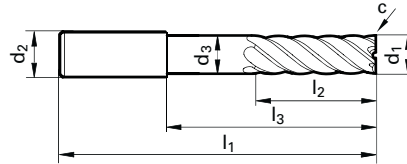

d1 h10	d2 h6	d3	l1	l2	l3	Chamfer	No. of Flutes	Code no.	EDP Number
inch	inch	inch	inch	inch	inch	inch			
1/4	1/4	0.238	3	3/4	1 1/2	0.004	6	6.350	9031830063500
5/16	5/16	0.301	3	7/8	1 1/2	0.004	6	7.940	9031830079400
3/8	3/8	0.363	3	7/8	1 1/2	0.004	6	9.520	9031830095200
1/2	1/2	0.480	4 1/2	1	2 3/4	0.006	6	12.700	9031830127000
5/8	5/8	0.605	5	1 1/4	3	0.006	6	15.870	9031830158700
3/4	3/4	0.730	5	1 1/2	3	0.006	8	19.050	9031830190500

# FINISH-TECH 62 GH100 H (6/8-Flute) - Metric - XL Length

## center cutting



Tool material

**Solid Carbide**

Surface finish

nano-Si®

Series

**3716**

Application group	Material examples	Ideal for
<b>P</b>	Steel	—
<b>M</b>	Stainless steel	—
<b>K</b>	Cast iron	○
<b>N</b>	Aluminum	—
<b>S</b>	Ni / Ti alloys	—
<b>H</b>	Hardened steel	●

●=Optimal    ○=Secondary

Speed and Feed data found on page 305

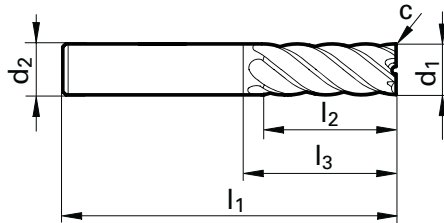

d1 h10	d2 h6	l1	l2	l3	c	No. of Flutes	Code no.	EDP Number
mm	mm	mm	mm	mm	mm x 45°			
6.000	6.000	75.00	30.00	39.00	0.05	6	6.000	9037160060000
8.000	8.000	100.00	40.00	64.00	0.10	6	8.000	9037160080000
10.000	10.000	100.00	40.00	60.00	0.10	6	10.000	9037160100000
12.000	12.000	150.00	45.00	105.00	0.10	6	12.000	9037160120000
16.000	16.000	150.00	65.00	102.00	0.15	6	16.000	9037160160000
20.000	20.000	150.00	65.00	100.00	0.15	8	20.000	9037160200000



# GF 500 HSC

## GF 500 HSC Trace Milling Cutters with ball nose or Torus form

GF 500 HSC (High Speed Cutting) trace milling cutters are suitable for all roughing, finishing as well as fine finishing operations under HSC conditions in the mould and die industry. The range of application includes all general steels as well as high-alloyed steels but also hardened materials from 40 to 54 HRC.

The new web thinning form provides optimal chip evacuation as well as stability. In addition, the extremely close tolerances on radius and diameter ensure a very high contour accuracy on the workpiece, improving tool life considerably. A completely new grinding process produces considerably smoother cutting edges and flutes and also results in a clear increase in tool life.

GF 500 B HSC ball nose trace milling cutters and GF 500 T HSC-trace milling cutters with Torus form are both available with different lengths. The combination of the new geometries with reinforced shanks as well as reduced neck diameters allows extremely high feed rates and also provides high rigidity and optimal collision protection even for increased cutting depths.

### Advantages at a glance:

- Accurate tolerances on diameter
- Close radius tolerances
- Radius grind with constant helix correction
- Straight and radius areas ground in one pass
- Grinding process for highest Surface finish finishes

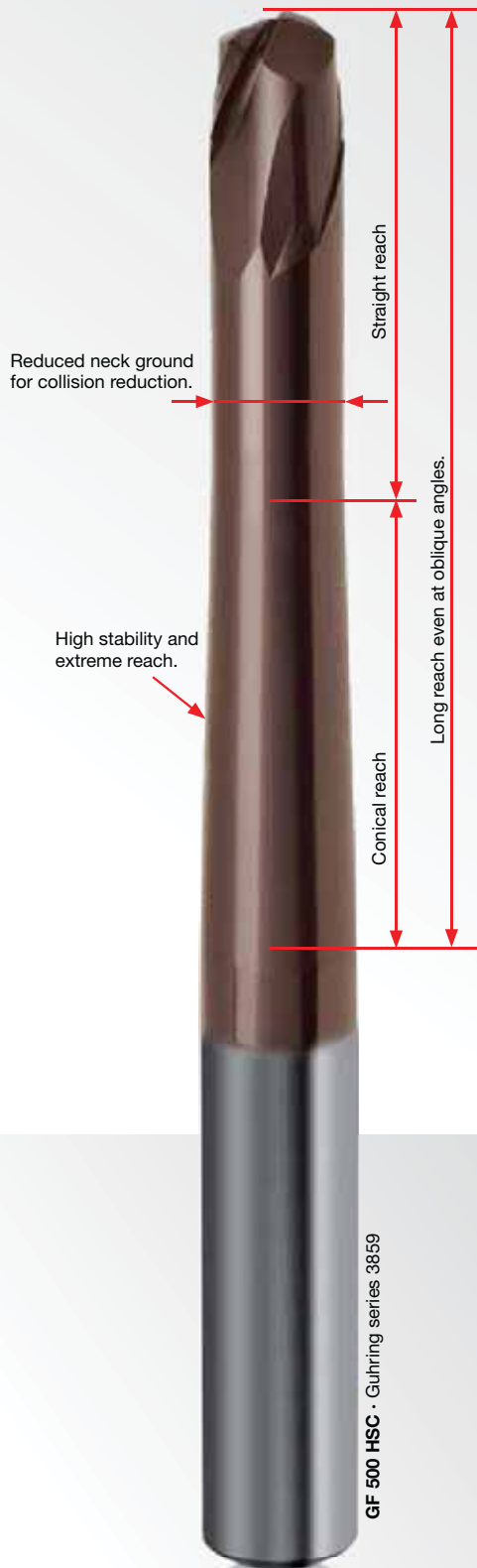

Optimal wear protection thanks to radius grind with constant rake angle and continuous helix.



Seamless radius area provides high form and contour accuracy.



# HSC-Profile Cutters with Torus Form GF 500 T - Metric - Standard Length

center cutting

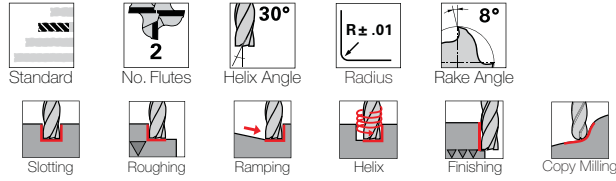

Tool material

**Solid Carbide**

Surface finish

nano-Si®

Series

**3856**

Application group	Material examples	Ideal for
<b>P</b>	Steel	●
<b>M</b>	Stainless steel	●
<b>K</b>	Cast iron	●
<b>N</b>	Aluminum	—
<b>S</b>	Ni / Ti alloys	●
<b>H</b>	Hardened steel	●

●=Optimal ○=Secondary

Speed and Feed data found on page 309

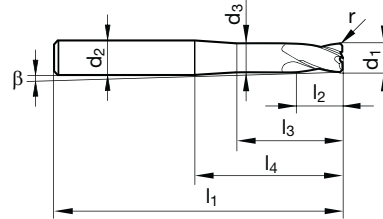

d1 h8	d2 h6	d3	l1	l2	l3	l4	r	β	No. of Flutes	Code no.	EDP Number
mm	mm	mm	mm	mm	mm	mm	mm	°			
2.000	6.000	1.800	57.00	3.00	8.00	20.00	0.50	5.90	2	2.000	9038560020000
3.000	6.000	2.800	57.00	3.50	9.00	20.00	0.50	4.40	2	3.000	9038560030000
4.000	6.000	3.800	57.00	4.00	9.40	20.00	1.00	3.10	2	4.000	9038560040000
6.000	6.000	5.600	57.00	6.00	19.00	20.00	2.00	-	2	6.000	9038560060000
8.000	8.000	7.600	63.00	7.00	25.00	26.00	2.00	-	2	8.000	9038560080000
10.000	10.000	9.600	72.00	8.00	28.00	30.00	3.00	-	2	10.000	9038560100000
12.000	12.000	11.500	83.00	10.00	33.00	35.00	4.00	-	2	12.000	9038560120000

# HSC-Profile Cutters with Torus Form GF 500 T - Metric - Long Length

## center cutting



Long



No. Flutes



Helix Angle



Radius



Rake Angle



Slotting



Roughing



Ramping



Helix



Finishing



Copy Milling

Tool material

**Solid Carbide**

Surface finish

nano-Si®

Series

**3859**

Application group	Material examples	Ideal for
<b>P</b>	Steel	●
<b>M</b>	Stainless steel	●
<b>K</b>	Cast iron	●
<b>N</b>	Aluminum	—
<b>S</b>	Ni / Ti alloys	●
<b>H</b>	Hardened steel	●

●=Optimal ○=Secondary

Speed and Feed data found on page 309

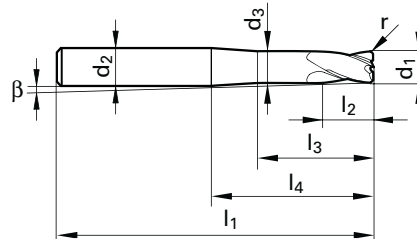

d1 h8	d2 h6	d3	l1	l2	l3	l4	r	β	No. of Flutes	Code no.	EDP Number
mm	mm	mm	mm	mm	mm	mm	mm	°			
2.000	6.000	1.800	80.00	3.00	8.00	40.00	0.50	2.90	2	2.000	9038590020000
3.000	6.000	2.800	80.00	3.50	12.00	40.00	0.50	2.20	2	3.000	9038590030000
4.000	6.000	3.800	80.00	4.00	20.00	40.00	1.00	1.50	2	4.000	9038590040000
6.000	8.000	5.600	100.00	6.00	59.00	60.00	2.00	1.00	2	6.000	9038590060000
8.000	10.000	7.600	120.00	7.00	74.00	75.00	2.00	0.80	2	8.000	9038590080000
10.000	12.000	9.600	120.00	8.00	68.00	70.00	3.00	0.90	2	10.000	9038590100000
12.000	16.000	11.500	150.00	10.00	95.80	100.00	4.00	1.20	2	12.000	9038590120000

# HSC-Profile Cutters with Torus Form GF 500 T - Metric - Long Length

center cutting



Long



No. Flutes



Helix Angle



Radius



Rake Angle



Slotting



Roughing



Ramping



Helix



Finishing



Copy Milling

Tool material

**Solid Carbide**

Surface finish

nano-Si®

Series

**3865**

Application group	Material examples	Ideal for
<b>P</b>	Steel	●
<b>M</b>	Stainless steel	●
<b>K</b>	Cast iron	●
<b>N</b>	Aluminum	—
<b>S</b>	Ni / Ti alloys	●
<b>H</b>	Hardened steel	●

●=Optimal ○=Secondary

Speed and Feed data found on page 309

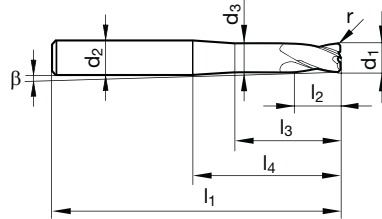

d1 h8	d2 h6	d3	l1	l2	l3	l4	r	β	No. of Flutes	Code no.	EDP Number
mm	mm	mm	mm	mm	mm	mm	mm	°			
6.000	6.000	5.600	80.00	6.00	39.00	40.00	2.00	-	2	6.000	9038650060000
8.000	8.000	7.600	100.00	7.00	59.00	60.00	2.00	-	2	8.000	9038650080000
10.000	10.000	9.600	120.00	8.00	73.00	75.00	3.00	-	2	10.000	9038650100000
12.000	12.000	11.500	120.00	10.00	68.00	70.00	4.00	-	2	12.000	9038650120000



# HSC-Profile Cutters with Torus Form GF 500 T - Metric - Long Length

## center cutting



Long



No. Flutes



Helix Angle



Radius



Rake Angle



Slotting



Roughing



Ramping



Helix



Finishing



Copy Milling

Tool material

**Solid Carbide**

Surface finish

nano-Si®

Series

**3863**

Application group	Material examples	Ideal for
P	Steel	●
M	Stainless steel	●
K	Cast iron	●
N	Aluminum	—
S	Ni / Ti alloys	●
H	Hardened steel	●

●=Optimal ○=Secondary

Speed and Feed data found on page 309

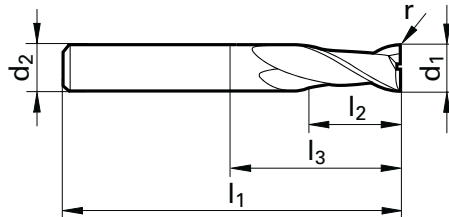

d1 e8	d2 h6	l1	l2	l3	r	No. of Flutes	Code no.	EDP Number
mm	mm	mm	mm	mm	mm			
4.000	4.000	80.00	8.00	52.00	0.50	2	4.000	9038630040000
6.000	6.000	100.00	12.00	64.00	1.00	2	6.000	9038630060000
8.000	8.000	100.00	16.00	64.00	1.00	2	8.000	9038630080000
10.000	10.000	100.00	20.00	60.00	1.00	2	10.000	9038630100000
12.000	12.000	120.00	24.00	75.00	1.50	2	12.000	9038630120000

# HSC-Profile Cutters with Torus Form GF 500 T - Metric - XL Length

## center cutting

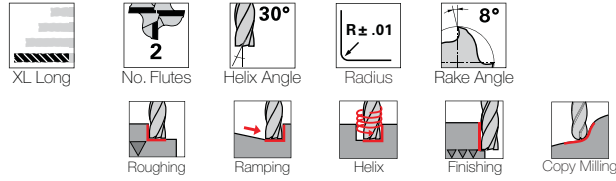

Tool material

**Solid Carbide**

Surface finish

nano-Si®

Series

**3860**

Application group	Material examples	Ideal for
<b>P</b>	Steel	●
<b>M</b>	Stainless steel	●
<b>K</b>	Cast iron	●
<b>N</b>	Aluminum	—
<b>S</b>	Ni / Ti alloys	●
<b>H</b>	Hardened steel	●

●=Optimal ○=Secondary

Speed and Feed data found on page 309

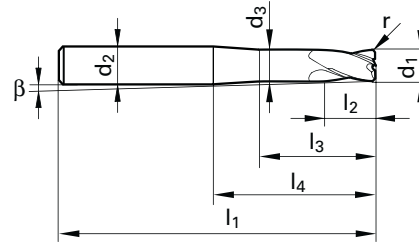

d1 h8	d2 h6	d3	l1	l2	l3	l4	r	β	No. of Flutes	Code no.	EDP Number
mm	mm	mm	mm	mm	mm	mm	mm	°			
2.000	6.000	1.800	80.00	3.00	8.00	40.00	0.50	2.90	2	2.000	9038600020000
3.000	6.000	2.800	80.00	3.50	12.00	40.00	0.50	2.20	2	3.000	9038600030000
4.000	6.000	3.800	100.00	4.00	20.00	60.00	0.50	1.00	2	4.000	9038600040000
6.000	8.000	5.600	120.00	6.00	79.00	80.00	1.00	0.80	2	6.000	9038600060000
8.000	10.000	7.600	150.00	7.00	104.00	105.00	1.00	0.60	2	8.000	9038600080000

# HSC-Profile Cutters with Ball Nose GF 500 B - Metric - Standard Length

## center cutting



Standard



No. Flutes



Helix Angle



Radius



Rake Angle



Slotting



Roughing



Ramping



Helix



Finishing



Copy Milling

Tool material

Surface finish

**Solid Carbide**

nano-Si®

Series

**3854**

Application group	Material examples	Ideal for
P	Steel	●
M	Stainless steel	●
K	Cast iron	●
N	Aluminum	—
S	Ni / Ti alloys	●
H	Hardened steel	●

●=Optimal ○=Secondary

Speed and Feed data found on page 308

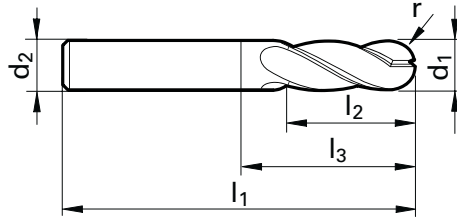

d1 h8	d2 h6	l1	l2	l3	r	No. of Flutes	Code no.	EDP Number
mm	mm	mm	mm	mm	mm			
6.000	6.000	57.00	12.00	21.00	3.00	2	6.000	9038540060000
8.000	8.000	63.00	16.00	27.00	4.00	2	8.000	9038540080000
10.000	10.000	72.00	20.00	32.00	5.00	2	10.000	9038540100000
12.000	12.000	83.00	24.00	38.00	6.00	2	12.000	9038540120000

# HSC-Profile Cutters with Ball Nose GF 500 B - Metric - Standard Length

center cutting



Standard



No. Flutes



Helix Angle



Radius



Rake Angle



Slotting



Roughing



Ramping



Helix



Finishing



Copy Milling

Tool material

Solid Carbide

Surface finish

nano-Si®

Series

3848

Application group	Material examples	Ideal for
P	Steel	●
M	Stainless steel	●
K	Cast iron	●
N	Aluminum	—
S	Ni / Ti alloys	●
H	Hardened steel	●

●=Optimal ○=Secondary

Speed and Feed data found on page 308

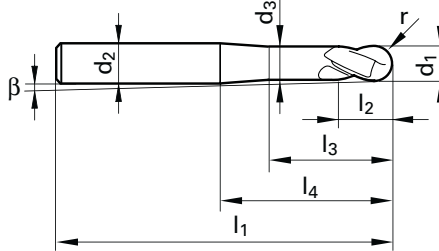

d1 h8	d2 h6	d3	l1	l2	l3	l4	r	β	No. of Flutes	Code no.	EDP Number
mm	mm	mm	mm	mm	mm	mm	mm	°			
2.000	6.000	1.800	57.00	3.00	6.20	20.00	1.00	6.10	2	2.000	9038480020000
3.000	6.000	2.800	57.00	3.50	8.40	20.00	1.50	4.70	2	3.000	9038480030000
4.000	6.000	3.800	57.00	4.00	9.40	20.00	2.00	3.20	2	4.000	9038480040000
6.000	6.000	5.600	57.00	6.00	19.00	20.00	3.00	-	2	6.000	9038480060000
8.000	8.000	7.600	63.00	7.00	25.00	26.00	4.00	-	2	8.000	9038480080000
10.000	10.000	9.600	72.00	8.00	28.00	30.00	5.00	-	2	10.000	9038480100000
12.000	12.000	11.500	83.00	10.00	33.00	35.00	6.00	-	2	12.000	9038480120000

# HSC-Profile Cutters with Ball Nose GF 500 B - Metric - Long Length

## center cutting



Long



No. Flutes



Helix Angle



Radius



Rake Angle



Slotting



Roughing



Ramping



Helix



Finishing



Copy Milling

Tool material

Solid Carbide

Surface finish

nano-Si®

Series

3866

Application group	Material examples	Ideal for
P	Steel	●
M	Stainless steel	●
K	Cast iron	●
N	Aluminum	—
S	Ni / Ti alloys	●
H	Hardened steel	●

●=Optimal ○=Secondary

Speed and Feed data found on page 308

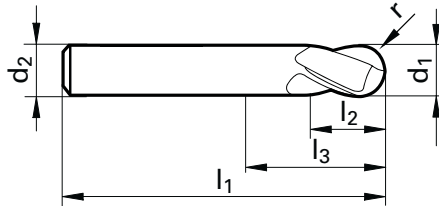

d1 h8	d2 h6	l1	l2	l3	r	No. of Flutes	Code no.	EDP Number
mm	mm	mm	mm	mm	mm			
4.000	4.000	80.00	8.00	52.00	2.00	2	4.000	9038660040000
6.000	6.000	100.00	12.00	64.00	3.00	2	6.000	9038660060000
8.000	8.000	100.00	16.00	64.00	4.00	2	8.000	9038660080000
10.000	10.000	100.00	20.00	60.00	5.00	2	10.000	9038660100000
12.000	12.000	120.00	24.00	75.00	6.00	2	12.000	9038660120000

# HSC-Profile Cutters with Ball Nose GF 500 B - Metric - Long Length

## center cutting



Long



No. Flutes



Helix Angle



Radius



Rake Angle



Slotting



Roughing



Ramping



Helix



Finishing



Copy Milling

Tool material

Solid Carbide

Surface finish

nano-Si®

Series

3855

Application group	Material examples	Ideal for
P	Steel	●
M	Stainless steel	●
K	Cast iron	●
N	Aluminum	—
S	Ni / Ti alloys	●
H	Hardened steel	●

●=Optimal ○=Secondary

Speed and Feed data found on page 308

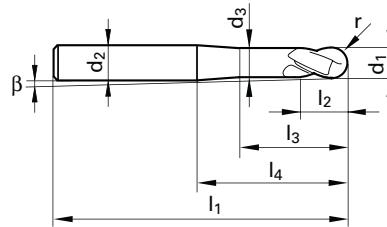

d1 h8	d2 h6	d3	l1	l2	l3	l4	r	β	No. of Flutes	Code no.	EDP Number
mm	mm	mm	mm	mm	mm	mm	mm	°			
6.000	6.000	5.600	80.00	6.00	39.00	40.00	3.00	-	2	6.000	9038550060000
8.000	8.000	7.600	100.00	7.00	59.00	60.00	4.00	-	2	8.000	9038550080000
10.000	10.000	9.600	120.00	8.00	73.00	75.00	5.00	-	2	10.000	9038550100000
12.000	12.000	11.500	120.00	10.00	68.00	70.00	6.00	-	2	12.000	9038550120000

# HSC-Profile Cutters with Ball Nose GF 500 B - Metric - Long Length

## center cutting



Long



No. Flutes



Helix Angle



Radius



Rake Angle



Slotting



Roughing



Ramping



Helix



Finishing



Copy Milling

Tool material

Solid Carbide

Surface finish

nano-Si®

Series

3849

Application group	Material examples	Ideal for
P	Steel	●
M	Stainless steel	●
K	Cast iron	●
N	Aluminum	—
S	Ni / Ti alloys	●
H	Hardened steel	●

●=Optimal ○=Secondary

Speed and Feed data found on page 308

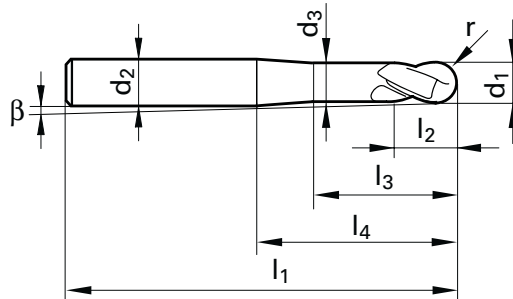

d1 h8	d2 h6	d3	l1	l2	l3	l4	r	β	No. of Flutes	Code no.	EDP Number
mm	mm	mm	mm	mm	mm	mm	mm	°			
2.000	6.000	1.800	80.00	3.00	8.00	40.00	1.00	3.00	2	2.000	9038490020000
3.000	6.000	2.800	80.00	3.50	12.00	40.00	1.50	2.30	2	3.000	9038490030000
4.000	6.000	3.800	80.00	4.00	20.00	40.00	2.00	1.60	2	4.000	9038490040000
5.000	6.000	4.700	80.00	5.00	25.00	40.00	2.50	0.80	2	5.000	9038490050000
6.000	8.000	5.600	100.00	6.00	25.00	60.00	3.00	1.10	2	6.000	9038490060000
8.000	10.000	7.600	120.00	7.00	30.00	75.00	4.00	0.90	2	8.000	9038490080000
10.000	12.000	9.600	120.00	8.00	30.00	70.00	5.00	0.90	2	10.000	9038490100000
12.000	16.000	11.500	150.00	10.00	35.00	100.00	6.00	1.30	2	12.000	9038490120000

# HSC-Profile Cutters with Ball Nose GF 500 B - Metric - XL Length

## center cutting

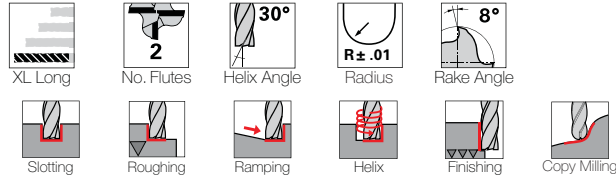

Tool material

**Solid Carbide**

Surface finish

nano-Si®

Series

**3853**

Application group	Material examples	Ideal for
<b>P</b>	Steel	●
<b>M</b>	Stainless steel	●
<b>K</b>	Cast iron	●
<b>N</b>	Aluminum	—
<b>S</b>	Ni / Ti alloys	●
<b>H</b>	Hardened steel	●

●=Optimal ○=Secondary

Speed and Feed data found on page 308

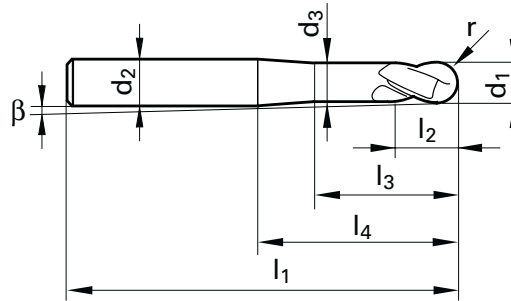

d1 h8	d2 h6	d3	l1	l2	l3	l4	r	β	No. of Flutes	Code no.	EDP Number
mm	mm	mm	mm	mm	mm	mm	mm	°			
2.000	6.000	1.800	80.00	3.00	8.00	40.00	1.00	3.00	2	2.000	9038530020000
3.000	6.000	2.800	80.00	3.50	12.00	40.00	1.50	2.30	2	3.000	9038530030000
4.000	6.000	3.800	100.00	4.00	20.00	60.00	2.00	1.00	2	4.000	9038530040000
6.000	8.000	5.600	120.00	6.00	25.00	80.00	3.00	0.80	2	6.000	9038530060000
8.000	10.000	7.600	150.00	7.00	20.00	105.00	4.00	0.60	2	8.000	9038530080000



# High Feed HF 300 (4-Flute) - Metric - Standard Length



Standard



No. Flutes



Helix Angle



Rake Angle



Roughing



Ramping



Helix



Copy Milling

Tool material

Solid Carbide

Surface finish

nano-Si®

Series

6771

Application group	Material examples	Ideal for
P	Steel	●
M	Stainless steel	○
K	Cast iron	●
N	Aluminum	—
S	Ni / Ti alloys	○
H	Hardened steel	●

●=Optimal ○=Secondary

Speed and Feed data found on page 304

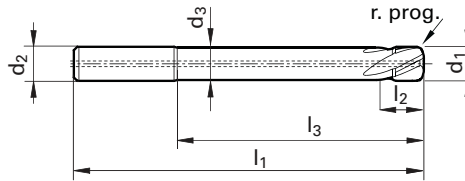

d1 h10	d2 h6	d3	l1	l2	l3	r	No. of Flutes	Code no.	EDP Number
mm	mm	mm	mm	mm	mm	mm x 45°			
3.000	6.000	2.800	57.00	2.00	15.00	0.50	4	3.000	9067710030000
4.000	6.000	3.800	57.00	3.00	18.00	0.80	4	4.000	9067710040000
5.000	6.000	4.800	57.00	4.00	20.00	0.80	4	5.000	9067710050000
6.000	6.000	5.700	57.00	5.00	21.00	1.00	4	6.000	9067710060000
8.000	8.000	7.700	63.00	6.00	27.00	1.50	4	8.000	9067710080000
10.000	10.000	9.500	72.00	8.00	32.00	2.00	4	10.000	9067710100000
12.000	12.000	11.500	83.00	10.00	38.00	2.00	4	12.000	9067710120000
16.000	16.000	15.500	92.00	12.00	44.00	2.50	4	16.000	9067710160000

# High Feed HF 300 (4-Flute) - Metric - XL Long Length

**NEW**

**Y**

**HA**



Tool material

**Solid Carbide**

Surface finish

nano-Si®

Series

**6772**

Application group	Material examples	Ideal for
<b>P</b>	Steel	●
<b>M</b>	Stainless steel	○
<b>K</b>	Cast iron	●
<b>N</b>	Aluminum	—
<b>S</b>	Ni / Ti alloys	○
<b>H</b>	Hardened steel	●

●=Optimal    ○=Secondary

Speed and Feed data found on page 304

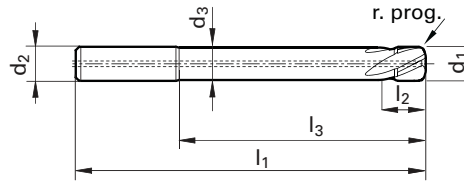

d1 h10	d2 h6	d3	l1	l2	l3	r	No. of Flutes	Code no.	EDP Number
mm	mm	mm	mm	mm	mm	mm x 45°			
3.000	6.000	2.800	80.00	2.00	30.00	0.50	4	3.000	9067720030000
4.000	6.000	3.800	80.00	3.00	32.00	0.80	4	4.000	9067720040000
5.000	6.000	4.800	80.00	4.00	40.00	0.80	4	5.000	9067720050000
6.000	6.000	5.700	80.00	5.00	44.00	1.00	4	6.000	9067720060000
8.000	8.000	7.700	100.00	6.00	64.00	1.50	4	8.000	9067720080000
10.000	10.000	9.500	120.00	8.00	75.00	2.00	4	10.000	9067720100000
12.000	12.000	11.500	120.00	10.00	75.00	2.00	4	12.000	9067720120000
16.000	16.000	15.500	150.00	12.00	100.00	2.50	4	16.000	9067720160000

# GF 300 B/T

Ball nose and Torus end mills  
for high performance milling in  
materials < 62 HRC

The die and mold industry places ever higher demands on milling cutters – primarily with regard to accuracy and tool life. Therefore, Guhring's cutting tool program now includes radius milling cutters that are perfectly adapted to satisfy these demands and provide optimal machining results thanks to application orientated geometries, carbide grades and coatings. The advantages are especially high form and contour accuracy of the workpiece, minimal wear and therefore excellent tool life.

## Advantages at a glance:

- Outside diameter and the radius is ground in one-pass
- Radius point geometry with constant helix-radius-correction
- Reduced neck ground for collision reduction with protruding edges

← Reduced neck ground  
for collision reduction

GF 300 T - Guhring series 3361

GF 300 B - Guhring series 3360



High wear protection thanks to radius  
geometry with constant rake angle and  
continuous spiral.



Seamless radius area provides high  
form and contour accuracy.

# Hard Profile Cutters with Torus Grind GF 300 T - Metric - Standard Length

center cutting



Standard



No. Flutes



Helix Angle



Radius



Rake Angle



Roughing



Ramping



Helix



Finishing



Copy Milling

Tool material

Solid Carbide

Surface finish

nano-Si®

Series

3361

Application group	Material examples	Ideal for
P	Steel	●
M	Stainless steel	—
K	Cast iron	●
N	Aluminum	—
S	Ni / Ti alloys	—
H	Hardened steel	●

●=Optimal ○=Secondary

Speed and Feed data found on page 309

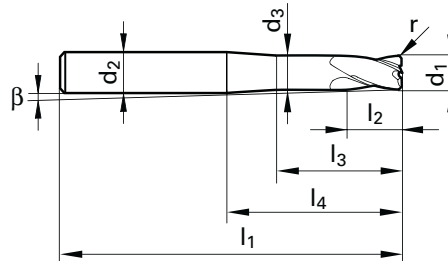

d1 h8	d2 h6	d3	l1	l2	l3	l4	r	β	No. of Flutes	Code no.	EDP Number
mm	mm	mm	mm	mm	mm	mm	mm	°			
3.000	6.000	2.700	57.00	5.00	10.00	21.00	0.50	4.20	4	3.000	9033610030000
4.000	6.000	3.700	57.00	6.00	13.40	21.00	0.50	2.80	4	4.000	9033610040000
5.000	6.000	4.700	57.00	8.00	15.90	21.00	0.50	1.40	4	5.000	9033610050000
6.000	6.000	5.700	57.00	9.00	20.00	21.00	1.00	-	4	6.000	9033610060000
8.000	8.000	7.700	63.00	12.00	26.00	27.00	1.00	-	4	8.000	9033610080000
10.000	10.000	9.500	72.00	15.00	30.00	32.00	1.50	-	4	10.000	9033610100000
12.000	12.000	11.500	83.00	18.00	36.00	38.00	1.50	-	4	12.000	9033610120000
16.000	16.000	15.500	92.00	24.00	42.00	44.00	2.00	-	4	16.000	9033610160000

# Hard Profile Cutters with Torus Grind GF 300 T - Inch - Long Length

## center cutting



Long



No. Flutes



Helix Angle



Radius



Rake Angle



Roughing



Ramping



Helix



Finishing



Copy Milling

Tool material

Solid Carbide

Surface finish

nano-Si®

Series

3192

Application group	Material examples	Ideal for
P	Steel	●
M	Stainless steel	—
K	Cast iron	●
N	Aluminum	—
S	Ni / Ti alloys	—
H	Hardened steel	●

●=Optimal ○=Secondary

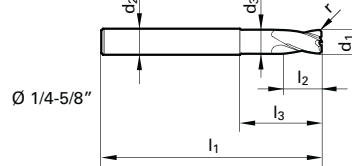
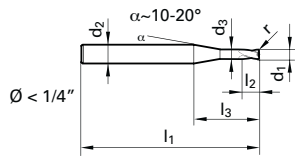

Speed and Feed data found on page 296

d1 h10	d2 h6	d3	l1	l2	l3	Radius	No. of Flutes	Code no.	EDP Number
inch	inch	inch	inch	inch	inch	inch			
3/16	1/4	0.175	2 1/2	3/16	3/4	0.008	4	4.760	9031920047600
1/4	1/4	0.230	3	1/4	1 1/2	0.010	4	6.350	9031920063500
5/16	5/16	0.292	3	5/16	1 1/2	0.013	4	7.940	9031920079400
3/8	3/8	0.355	3	3/8	1 1/2	0.013	4	9.520	9031920095200
1/2	1/2	0.480	4 1/2	1/2	2 3/4	0.020	4	12.700	9031920127000
5/8	5/8	0.605	5	5/8	3	0.025	4	15.870	9031920158700

# Hard Profile Cutters with Torus Grind GF 300 T - Metric - XL Long Length

center cutting



Tool material

Solid Carbide

Surface finish

nano-Si®

Series

3362

Application group	Material examples	Ideal for
P	Steel	●
M	Stainless steel	—
K	Cast iron	●
N	Aluminum	—
S	Ni / Ti alloys	—
H	Hardened steel	●

●=Optimal ○=Secondary

Speed and Feed data found on page 309

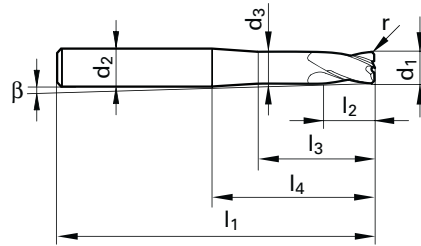

d1 h8	d2 h6	d3	l1	l2	l3	l4	r	No. of Flutes	Code no.	EDP Number
6.00	6.00	5.70	75.00	9.00	38.00	39.00	1.00	4	6.0	9033620060000
8.00	8.00	7.70	100.00	12.00	63.00	64.00	1.00	4	8.0	9033620080000
10.00	10.00	9.50	100.00	15.00	58.00	60.00	1.50	4	10.0	9033620100000
12.00	12.00	11.50	150.00	18.00	103.00	105.00	1.50	4	12.0	9033620120000
16.00	16.00	15.50	150.00	24.00	100.00	102.00	2.00	4	16.0	9033620160000

# Ball Nose Hard Profile Cutters GF 300 B - Inch - Standard Length

## center cutting



Standard



No. Flutes



Helix Angle



Radius



Rake Angle



Roughing



Ramping



Helix



Finishing



Copy Milling

Tool material

Solid Carbide

Surface finish

nano-Si®

Series

3101

Application group	Material examples	Ideal for
P	Steel	●
M	Stainless steel	—
K	Cast iron	●
N	Aluminum	—
S	Ni / Ti alloys	—
H	Hardened steel	●

●=Optimal ○=Secondary

Speed and Feed data found on page 295

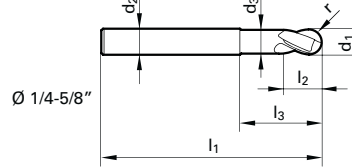
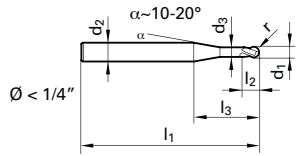

d1 h10	d2 h6	d3	l1	l2	l3	Radius	No. of Flutes	Code no.	EDP Number
inch	inch	inch	inch	inch	inch	inch			
1/8	1/4	0.113	2	1/8	1/2	0.063	2	3.170	9031010031700
3/16	1/4	0.176	2	3/16	1/2	0.094	2	4.760	9031010047600
1/4	1/4	0.238	2	1/4	11/16	0.125	2	6.350	9031010063500
5/16	5/16	0.300	2	5/16	1 3/16	0.156	2	7.940	9031010079400
3/8	3/8	0.363	2 1/2	3/8	1 3/16	0.188	2	9.520	9031010095200
1/2	1/2	0.480	3	1/2	1 7/16	0.25	2	12.700	9031010127000

# Ball Nose Hard Profile Cutters GF 300 B - Metric - Standard Length

## center cutting



Standard



No. Flutes



Helix Angle



Radius



Rake Angle



Roughing



Ramping



Helix



Finishing



Copy Milling



Tool material

Solid Carbide

Surface finish

nano-Si®

Series

3359

Application group	Material examples	Ideal for
P	Steel	●
M	Stainless steel	—
K	Cast iron	●
N	Aluminum	—
S	Ni / Ti alloys	—
H	Hardened steel	●

●=Optimal ○=Secondary

Speed and Feed data found on page 308

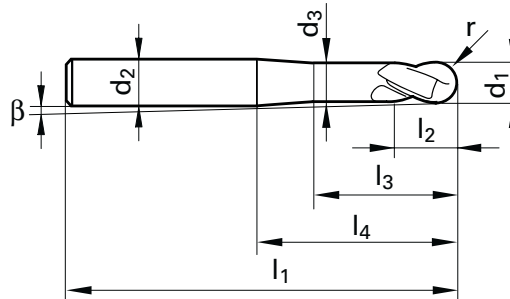

d1 h8	d2 h6	d3	l1	l2	l3	l4	r	β	No. of Flutes	Code no.	EDP Number
mm	mm	mm	mm	mm	mm	mm	mm	°			
0.500	3.000	0.400	38.00	0.75	2.60	10.00	0.25	7.40	2	0.500	9033590005000
0.800	3.000	0.700	38.00	1.20	3.50	10.00	0.40	6.60	2	0.800	9033590008000
1.000	3.000	0.900	38.00	1.50	4.00	10.00	0.50	6.10	2	1.000	9033590010000
1.500	3.000	1.400	38.00	2.25	5.50	10.00	0.75	4.70	2	1.500	9033590015000
2.000	6.000	1.900	57.00	3.00	9.40	21.00	1.00	5.80	2	2.000	9033590020000
3.000	6.000	2.700	57.00	5.00	11.60	21.00	1.50	4.40	2	3.000	9033590030000
4.000	6.000	3.700	57.00	6.00	14.50	21.00	2.00	3.10	2	4.000	9033590040000
5.000	6.000	4.700	57.00	8.00	17.30	21.00	2.50	1.60	2	5.000	9033590050000
6.000	6.000	5.700	57.00	9.00	20.00	21.00	3.00	-	2	6.000	9033590060000
8.000	8.000	7.700	63.00	12.00	26.00	27.00	4.00	-	2	8.000	9033590080000
10.000	10.000	9.500	72.00	15.00	30.00	32.00	5.00	-	2	10.000	9033590100000
12.000	12.000	11.500	83.00	18.00	36.00	38.00	6.00	-	2	12.000	9033590120000
16.000	16.000	15.500	92.00	24.00	42.00	44.00	8.00	-	2	16.000	9033590160000



# Ball Nose Hard Profile Cutters GF 300 B - Inch - Long Length

## center cutting



Long



No. of Flutes



Helix Angle



Radius



Rake Angle



Roughing



Ramping



Helix



Finishing



Copy Milling



Tool material

Solid Carbide

Surface finish

nano-Si®

Series

3191

Application group	Material examples	Ideal for
P	Steel	●
M	Stainless steel	—
K	Cast iron	●
N	Aluminum	—
S	Ni / Ti alloys	—
H	Hardened steel	●

●=Optimal ○=Secondary

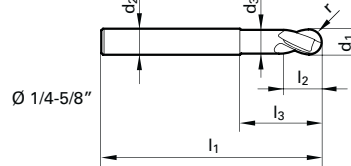
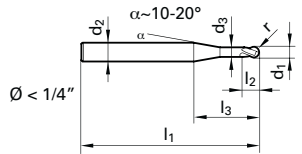

Speed and Feed data found on page 295

d1 h10	d2 h6	d3	l1	l2	l3	Radius	No. of Flutes	Code no.	EDP Number
inch	inch	inch	inch	inch	inch	inch			
1/8	1/4	0.113	2 1/2	1/8	1	0.063	2	3.170	9031910031700
3/16	1/4	0.176	2 1/2	3/16	1	0.094	2	4.760	9031910047600
1/4	1/4	0.238	3	1/4	1 1/2	0.125	2	6.350	9031910063500
5/16	5/16	0.300	3	5/16	1 1/2	0.156	2	7.940	9031910079400
3/8	3/8	0.363	3	3/8	1 1/2	0.188	2	9.520	9031910095200
1/2	1/2	0.480	4 1/2	1/2	2 3/4	0.25	2	12.700	9031910127000
5/8	5/8	0.605	5	5/8	3	0.313	2	15.870	9031910158700

# Ball Nose Hard Profile Cutters GF 300 B - Metric - XL Length

## center cutting

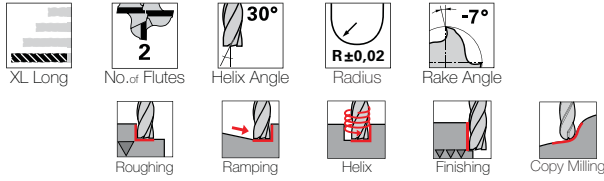

Tool material

**Solid Carbide**

Surface finish

nano-Si®

Series

**3360**

Application group	Material examples	Ideal for
P	Steel	●
M	Stainless steel	—
K	Cast iron	●
N	Aluminum	—
S	Ni / Ti alloys	—
H	Hardened steel	●

●=Optimal ○=Secondary

Speed and Feed data found on page 308

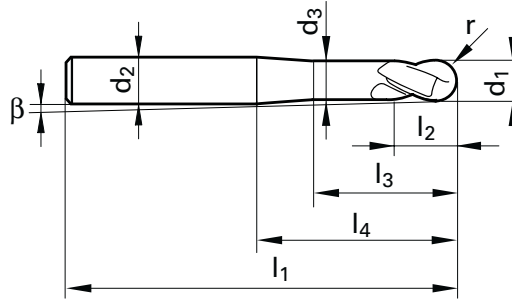

d1 h8	d2 h6	d3	l1	l2	l3	l4	r	β	No. of Flutes	Code no.	EDP Number
mm	mm	mm	mm	mm	mm	mm	mm	°			
3.000	6.000	2.700	75.00	5.00	20.00	39.00	1.50	2.30	2	3.000	9033600030000
4.000	6.000	3.700	75.00	6.00	20.00	39.00	2.00	1.60	2	4.000	9033600040000
5.000	6.000	4.700	75.00	8.00	20.00	39.00	2.50	0.80	2	5.000	9033600050000
6.000	6.000	5.700	75.00	9.00	38.00	39.00	3.00	-	2	6.000	9033600060000
8.000	8.000	7.700	100.00	12.00	63.00	64.00	4.00	-	2	8.000	9033600080000
10.000	10.000	9.500	100.00	15.00	58.00	60.00	5.00	-	2	10.000	9033600100000
12.000	12.000	11.500	150.00	18.00	103.00	105.00	6.00	-	2	12.000	9033600120000
16.000	16.000	15.500	150.00	24.00	100.00	102.00	8.00	-	2	16.000	9033600160000



# PRO-LINE

GENERAL PURPOSE  
SOLUTIONS



# UNI-PRO End Mills (2-Flute) - Inch - Stub Length



## center cutting

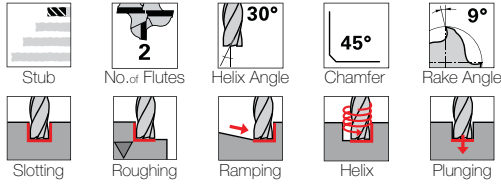

Tool material

**Solid Carbide**

Surface finish

FIREX®

Series

**3092**

Application group	Material examples	Ideal for
<b>P</b>	Steel	●
<b>M</b>	Stainless steel	●
<b>K</b>	Cast iron	●
<b>N</b>	Aluminum	○
<b>S</b>	Ni / Ti alloys	○
<b>H</b>	Hardened steel	--

●=Optimal    ○=Secondary

Speed and Feed data found on page 297

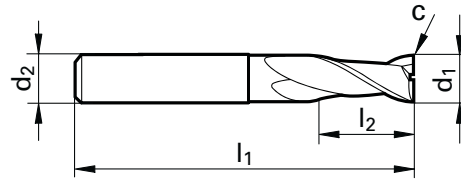

d1 h10	d2 h6	l1	l2	c	No. of Flutes	Code no.	EDP Number
inch	inch	inch	inch	inch x 45°			
1/16	1/8	2	1/8	0.001	2	1.590	9030920015900
1/8	1/8	1 1/2	1/4	0.002	2	3.170	9030920031700
3/16	3/16	2	3/8	0.002	2	4.760	9030920047600
1/4	1/4	2	1/2	0.004	2	6.350	9030920063500
5/16	5/16	2	1/2	0.004	2	7.940	9030920079400
3/8	3/8	2	5/8	0.004	2	9.520	9030920095200
7/16	7/16	2 1/2	5/8	0.006	2	11.110	9030920111100
1/2	1/2	2 1/2	5/8	0.006	2	12.700	9030920127000
5/8	5/8	3	3/4	0.006	2	15.870	9030920158700
3/4	3/4	3	1	0.006	2	19.050	9030920190500

# UNI-PRO End Mills (2-Flute) - Metric - Stub Length



## center cutting



Stub



No. of Flutes



Helix Angle



Chamfer



Rake Angle



Slotting



Roughing



Ramping



Helix



Plunging



HA



HB

Tool material

Solid Carbide

Surface finish

FIREX®

Series

3633

3634

Application group	Material examples	Ideal for
P	Steel	●
M	Stainless steel	●
K	Cast iron	●
N	Aluminum	○
S	Ni / Ti alloys	○
H	Hardened steel	--

●=Optimal ○=Secondary

Speed and Feed data found on page 310

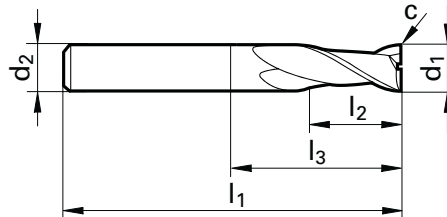

d1 h10	d2 h6	l1	l2	l3	c	No. of Flutes	Code no.	EDP Number	
mm	mm	mm	mm	mm	mm x 45°				
2.000	6.000	50.00	3.00	6.40	0.03	2	2.000	9036330020000	9036340020000
2.500	6.000	50.00	3.00	6.40	0.05	2	2.500	9036330025000	9036340025000
3.000	6.000	50.00	4.00	8.90	0.05	2	3.000	9036330030000	9036340030000
4.000	6.000	54.00	5.00	10.40	0.05	2	4.000	9036330040000	9036340040000
5.000	6.000	54.00	6.00	12.90	0.05	2	5.000	9036330050000	9036340050000
6.000	6.000	54.00	7.00	18.00	0.05	2	6.000	9036330060000	9036340060000
6.500	8.000	58.00	8.00	17.40	0.10	2	6.500	9036330065000	9036340065000
8.000	8.000	58.00	9.00	22.00	0.10	2	8.000	9036330080000	9036340080000
10.000	10.000	66.00	11.00	26.00	0.10	2	10.000	9036330100000	9036340100000
12.000	12.000	73.00	12.00	28.00	0.10	2	12.000	9036330120000	9036340120000
14.000	14.000	75.00	14.00	30.00	0.15	2	14.000	9036330140000	9036340140000
16.000	16.000	82.00	16.00	34.00	0.15	2	16.000	9036330160000	9036340160000
18.000	18.000	84.00	18.00	36.00	0.15	2	18.000	9036330180000	9036340180000
20.000	20.000	92.00	20.00	42.00	0.15	2	20.000	9036330200000	9036340200000

# UNI-PRO End Mills (2-Flute) - Inch - Standard Length



## center cutting

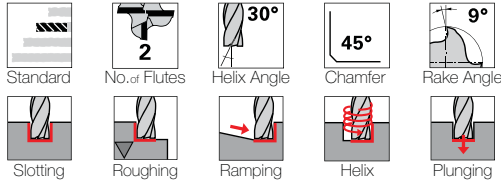

Tool material

**Solid Carbide**

**Solid Carbide**

Surface finish

bright

FIREX®

Series

**3146**

**3148**

Application group	Material examples	Ideal for
<b>P</b>	Steel	●
<b>M</b>	Stainless steel	●
<b>K</b>	Cast iron	●
<b>N</b>	Aluminum	●
<b>S</b>	Ni / Ti alloys	○
<b>H</b>	Hardened steel	--

●=Optimal    ○=Secondary

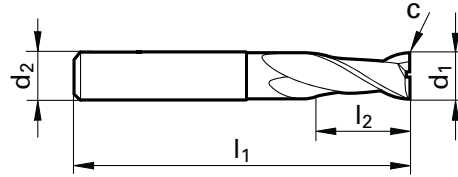

Speed and Feed data found on page 297

d1 h10	d2 h6	l1	l2	c	No. of Flutes	Code no.	EDP Number	EDP Number
inch	inch	inch	inch	inch x 45°				
1/16	1/8	11/2	3/16	0.001	2	1.590	9031460015900	9031480015900
5/64	1/8	11/2	9/32	0.001	2	1.980	9031460019800	9031480019800
3/32	1/8	11/2	9/32	0.002	2	2.380	9031460023800	9031480023800
7/64	1/8	11/2	3/8	0.002	2	2.780	9031460027800	9031480027800
1/8	1/8	11/2	3/8	0.002	2	3.170	9031460031700	9031480031700
9/64	3/16	2	1/2	0.002	2	3.570	9031460035700	9031480035700
5/32	3/16	2	1/2	0.002	2	3.970	9031460039700	9031480039700
11/64	3/16	2	5/8	0.002	2	4.370	9031460043700	9031480043700
3/16	3/16	2	5/8	0.002	2	4.760	9031460047600	9031480047600
13/64	1/4	2 1/2	5/8	0.002	2	5.160	9031460051600	9031480051600
7/32	1/4	2 1/2	5/8	0.002	2	5.560	9031460055600	9031480055600
15/64	1/4	2 1/2	3/4	0.002	2	5.950	9031460059500	9031480059500
1/4	1/4	2 1/2	3/4	0.004	2	6.350	9031460063500	9031480063500
17/64	5/16	2 1/2	3/4	0.004	2	6.750	9031460067500	9031480067500
9/32	5/16	2 1/2	3/4	0.004	2	7.140	9031460071400	9031480071400
19/64	5/16	2 1/2	13/16	0.004	2	7.540	9031460075400	9031480075400
5/16	5/16	2 1/2	13/16	0.004	2	7.940	9031460079400	9031480079400
21/64	3/8	2 1/2	1	0.004	2	8.330	9031460083300	9031480083300
11/32	3/8	2 1/2	1	0.004	2	8.730	9031460087300	9031480087300
23/64	3/8	2 1/2	1	0.004	2	9.130	9031460091300	9031480091300
3/8	3/8	2 1/2	1	0.004	2	9.520	9031460095200	9031480095200
25/64	7/16	2 1/2	1	0.004	2	9.920	9031460099200	9031480099200
13/32	7/16	2 3/4	1	0.006	2	10.320	9031460103200	9031480103200
27/64	7/16	2 3/4	1	0.006	2	10.720	9031460107200	9031480107200
7/16	7/16	2 3/4	1	0.006	2	11.110	9031460111100	9031480111100
29/64	1/2	3	1	0.006	2	11.510	9031460115100	9031480115100
15/32	1/2	3	1	0.006	2	11.910	9031460119100	9031480119100
31/64	1/2	3	1	0.006	2	12.300	9031460123000	9031480123000
1/2	1/2	3	1	0.006	2	12.700	9031460127000	9031480127000
9/16	9/16	3 1/2	1 1/8	0.006	2	14.290	9031460142900	9031480142900
5/8	5/8	3 1/2	1 1/4	0.006	2	15.870	9031460158700	9031480158700
11/16	3/4	4	1 3/8	0.006	2	17.460	9031460174600	9031480174600
3/4	3/4	4	1 1/2	0.006	2	19.050	9031460190500	9031480190500
1	1	4	1 1/2	0.012	2	25.400	9031460254000	9031480254000

# UNI-PRO End Mills (2-Flute) - Inch - Standard Length



center cutting with corner radius

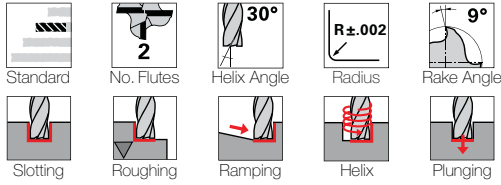

Tool material

**Solid Carbide**

Surface finish

FIREX®

Series

**3087**

Application group	Material examples	Ideal for
<b>P</b>	Steel	●
<b>M</b>	Stainless steel	●
<b>K</b>	Cast iron	●
<b>N</b>	Aluminum	○
<b>S</b>	Ni / Ti alloys	○
<b>H</b>	Hardened steel	--

●=Optimal    ○=Secondary

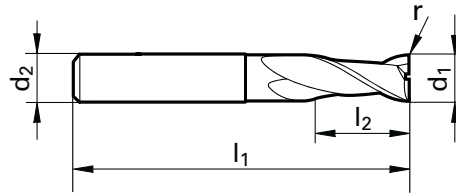

Speed and Feed data found on page 297

d1 h10	d2 h6	l1	l2	r	No. of Flutes	Code no.	EDP Number
inch	inch	inch	inch	inch			
1/8	1/8	1 1/2	3/8	0.015	2	3.172	9030870031720
1/8	1/8	1 1/2	3/8	0.031	2	3.174	9030870031740
3/16	3/16	2	5/8	0.015	2	4.762	9030870047620
3/16	3/16	2	5/8	0.031	2	4.764	9030870047640
3/16	3/16	2	5/8	0.062	2	4.766	9030870047660
1/4	1/4	2 1/2	3/4	0.015	2	6.352	9030870063520
1/4	1/4	2 1/2	3/4	0.031	2	6.354	9030870063540
1/4	1/4	2 1/2	3/4	0.062	2	6.356	9030870063560
5/16	5/16	2 1/2	13/16	0.015	2	7.942	9030870079420
5/16	5/16	2 1/2	13/16	0.031	2	7.944	9030870079440
5/16	5/16	2 1/2	13/16	0.062	2	7.946	9030870079460
3/8	3/8	2 1/2	1	0.015	2	9.522	9030870095220
3/8	3/8	2 1/2	1	0.031	2	9.524	9030870095240
3/8	3/8	2 1/2	1	0.062	2	9.526	9030870095260
1/2	1/2	3	1	0.015	2	12.702	9030870127020
1/2	1/2	3	1	0.031	2	12.704	9030870127040
1/2	1/2	3	1	0.062	2	12.706	9030870127060



# UNI-PRO End Mills (2-Flute) - Metric - Standard Length



## center cutting



Standard



No. of Flutes



Helix Angle



Chamfer



Rake Angle



Slotting



Roughing



Ramping



Helix



Plunging



HA



HA

Tool material

Solid Carbide

Surface finish

bright

FIREX®

Series

3303

3676

Application group	Material examples	Ideal for
P	Steel	●
M	Stainless steel	●
K	Cast iron	●
N	Aluminum	●
S	Ni / Ti alloys	○
H	Hardened steel	--

●=Optimal ○=Secondary

Speed and Feed data found on page 310

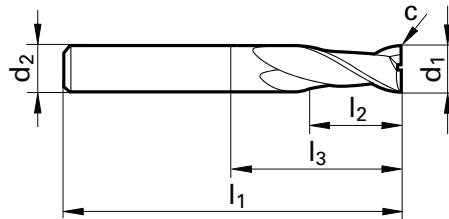

d1 h10	d2 h6	l1	l2	l3	c	No. of Flutes	Code no.	EDP Number	
mm	mm	mm	mm	mm	mm x 45°				
2.000	2.000	32.00	5.00	7.50	0.03	2	2.000	9033030020000	9036760020000
2.500	2.500	32.00	6.00	8.50	0.05	2	2.500	9033030025000	9036760025000
3.000	3.000	38.00	7.00	11.00	0.05	2	3.000	9033030030000	9036760030000
3.500	3.500	50.00	7.00	22.00	0.05	2	3.500	9033030035000	9036760035000
4.000	4.000	50.00	8.00	22.00	0.05	2	4.000	9033030040000	9036760040000
4.500	4.500	50.00	8.00	22.00	0.05	2	4.500	9033030045000	9036760045000
5.000	5.000	50.00	10.00	22.00	0.05	2	5.000	9033030050000	9036760050000
5.500	5.500	57.00	10.00	21.00	0.05	2	5.500	9033030055000	9036760055000
6.000	6.000	57.00	10.00	21.00	0.05	2	6.000	9033030060000	9036760060000
6.500	6.500	60.00	13.00	24.00	0.10	2	6.500	9033030065000	9036760065000
7.000	7.000	60.00	13.00	24.00	0.10	2	7.000	9033030070000	9036760070000
7.500	7.500	63.00	16.00	27.00	0.10	2	7.500	9033030075000	9036760075000
8.000	8.000	63.00	16.00	27.00	0.10	2	8.000	9033030080000	9036760080000
8.500	8.500	67.00	16.00	27.00	0.10	2	8.500	9033030085000	9036760085000
9.000	9.000	67.00	16.00	27.00	0.10	2	9.000	9033030090000	9036760090000
9.500	9.500	72.00	19.00	32.00	0.10	2	9.500	9033030095000	9036760095000
10.000	10.000	72.00	19.00	32.00	0.10	2	10.000	9033030100000	9036760100000
11.000	11.000	83.00	22.00	38.00	0.10	2	11.000	9033030110000	9036760110000
12.000	12.000	83.00	22.00	38.00	0.10	2	12.000	9033030120000	9036760120000
13.000	13.000	83.00	22.00	38.00	0.15	2	13.000	9033030130000	9036760130000
14.000	14.000	83.00	22.00	38.00	0.15	2	14.000	9033030140000	9036760140000
15.000	15.000	92.00	26.00	44.00	0.15	2	15.000	9033030150000	9036760150000
16.000	16.000	92.00	26.00	44.00	0.15	2	16.000	9033030160000	9036760160000
18.000	18.000	92.00	26.00	44.00	0.15	2	18.000	9033030180000	9036760180000
20.000	20.000	104.00	32.00	54.00	0.15	2	20.000	9033030200000	9036760200000

# UNI-PRO End Mills (2-Flute) - Metric - Standard Length



center cutting with corner radius

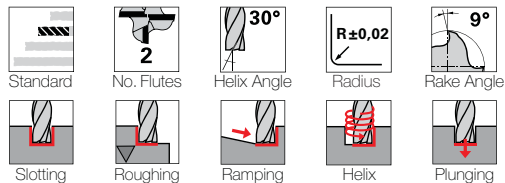

Tool material

Solid Carbide

Surface finish

bright

FIREX®

Series

3106

3561

Application group	Material examples	Ideal for
P	Steel	●
M	Stainless steel	●
K	Cast iron	●
N	Aluminum	●
S	Ni / Ti alloys	○
H	Hardened steel	--

●=Optimal ○=Secondary

Speed and Feed data found on page 310

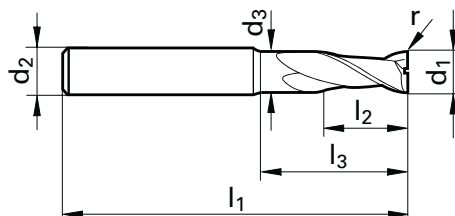

d1 h10	d2 h6	d3	l1	l2	l3	r	No. of Flutes	Code no.	EDP Number	
mm	mm	mm	mm	mm	mm					
6.000	6.000	5.700	57.00	10.00	20.00	0.50	2	6.005	9031060060050	9035610060050
6.000	6.000	5.700	57.00	10.00	20.00	1.00	2	6.010	9031060060100	9035610060100
8.000	8.000	7.700	63.00	16.00	26.00	0.50	2	8.005	9031060080050	9035610080050
8.000	8.000	7.700	63.00	16.00	26.00	1.00	2	8.010	9031060080100	9035610080100
8.000	8.000	7.700	63.00	16.00	26.00	1.50	2	8.015	9031060080150	9035610080150
8.000	8.000	7.700	63.00	16.00	26.00	2.00	2	8.020	9031060080200	9035610080200
10.000	10.000	9.500	72.00	19.00	30.00	0.50	2	10.005	9031060100050	9035610100050
10.000	10.000	9.500	72.00	19.00	30.00	1.00	2	10.010	9031060100100	9035610100100
10.000	10.000	9.500	72.00	19.00	30.00	1.50	2	10.015	9031060100150	9035610100150
10.000	10.000	9.500	72.00	19.00	30.00	2.00	2	10.020	9031060100200	9035610100200
12.000	12.000	11.500	83.00	22.00	36.00	0.50	2	12.005	9031060120050	9035610120050
12.000	12.000	11.500	83.00	22.00	36.00	1.00	2	12.010	9031060120100	9035610120100
12.000	12.000	11.500	83.00	22.00	36.00	1.50	2	12.015	9031060120150	9035610120150
12.000	12.000	11.500	83.00	22.00	36.00	2.00	2	12.020	9031060120200	9035610120200
16.000	16.000	15.500	92.00	26.00	42.00	1.00	2	16.010	9031060160100	9035610160100
16.000	16.000	15.500	92.00	26.00	42.00	1.50	2	16.015	9031060160150	9035610160150
16.000	16.000	15.500	92.00	26.00	42.00	2.00	2	16.020	9031060160200	9035610160200
20.000	20.000	19.500	104.00	32.00	52.00	1.00	2	20.010	9031060200100	9035610200100
20.000	20.000	19.500	104.00	32.00	52.00	1.50	2	20.015	9031060200150	9035610200150
20.000	20.000	19.500	104.00	32.00	52.00	2.00	2	20.020	9031060200200	9035610200200

# UNI-PRO End Mills (2-Flute) - Inch - Long Length



## center cutting

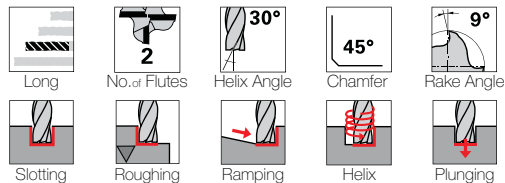

Tool material

**Solid Carbide**

Surface finish

bright

FIREX®

Series

**3147**

**3149**

Application group	Material examples	Ideal for
P	Steel	●
M	Stainless steel	●
K	Cast iron	●
N	Aluminum	●
S	Ni / Ti alloys	○
H	Hardened steel	○

●=Optimal ○=Secondary

Speed and Feed data found on page 297

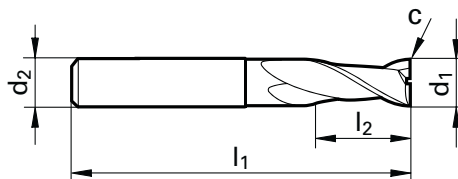

d1 h10	d2 h6	l1	l2	c	No. of Flutes	Code no.	EDP Number	
inch	inch	inch	inch	inch x 45°				
1/8	1/8	2	1/2	0.002	2	3.170	9031470031700	9031490031700
3/16	3/16	2 1/2	3/4	0.002	2	4.760	9031470047600	9031490047600
1/4	1/4	3	1 1/8	0.004	2	6.350	9031470063500	9031490063500
5/16	5/16	3	1 1/8	0.004	2	7.940	9031470079400	9031490079400
3/8	3/8	3	1 1/8	0.004	2	9.520	9031470095200	9031490095200
7/16	7/16	4 1/2	2	0.006	2	11.110	9031470111100	9031490111100
1/2	1/2	4 1/2	2	0.006	2	12.700	9031470127000	9031490127000
5/8	5/8	5	2 1/4	0.006	2	15.870	9031470158700	9031490158700
3/4	3/4	5	2 1/4	0.006	2	19.050	9031470190500	9031490190500
1	1	5	2 1/4	0.012	2	25.400	9031470254000	9031490254000

# UNI-PRO End Mills (2-Flute) - Inch - Long Length



center cutting with corner radius

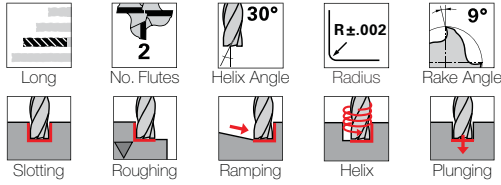

Tool material

**Solid Carbide**

Surface finish

FIREX®

Series

**3088**

Application group	Material examples	Ideal for
<b>P</b>	Steel	●
<b>M</b>	Stainless steel	●
<b>K</b>	Cast iron	●
<b>N</b>	Aluminum	○
<b>S</b>	Ni / Ti alloys	○
<b>H</b>	Hardened steel	--

●=Optimal    ○=Secondary

Speed and Feed data found on page 297

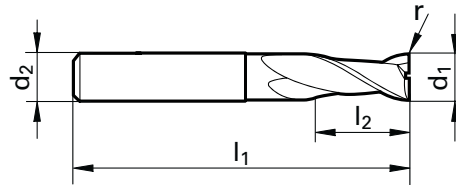

d1 h10	d2 h6	l1	l2	r	No. of Flutes	Code no.	EDP Number
inch	inch	inch	inch				
1/8	1/8	2	1/2	0.015	2	3.172	9030880031720
1/8	1/8	2	1/2	0.031	2	3.174	9030880031740
1/4	1/4	3	1 1/8	0.015	2	6.352	9030880063520
1/4	1/4	3	1 1/8	0.031	2	6.354	9030880063540
1/4	1/4	3	1 1/8	0.062	2	6.356	9030880063560
3/8	3/8	3	1 1/8	0.015	2	9.522	9030880095220
3/8	3/8	3	1 1/8	0.031	2	9.524	9030880095240
3/8	3/8	3	1 1/8	0.062	2	9.526	9030880095260
1/2	1/2	4 1/2	2	0.015	2	12.702	9030880127020
1/2	1/2	4 1/2	2	0.031	2	12.704	9030880127040
1/2	1/2	4 1/2	2	0.062	2	12.706	9030880127060

# UNI-PRO End Mills (2-Flute) - Metric - XL Long Length



## center cutting

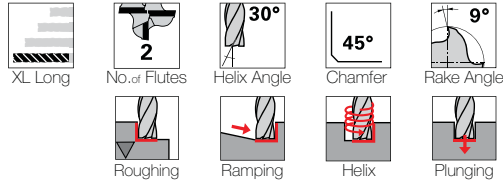

Tool material

**Solid Carbide**

Surface finish

bright

FIREX®

Series

**3011**

**3021**

Application group	Material examples	Ideal for
P	Steel	●
M	Stainless steel	●
K	Cast iron	●
N	Aluminum	●
S	Ni / Ti alloys	○
H	Hardened steel	--

●=Optimal    ○=Secondary

Speed and Feed data found on page 310

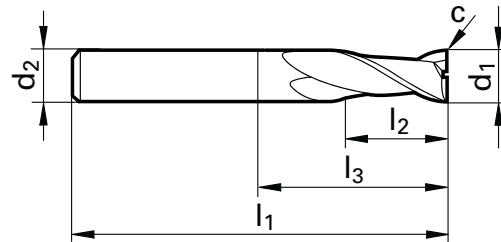

d1 h10	d2 h6	l1	l2	l3	c	No. of Flutes	Code no.	EDP Number	
mm	mm	mm	mm	mm	mm x 45°				
3.000	3.000	75.00	20.00	47.00	0.05	2	3.000	9030110030000	9030210030000
4.000	4.000	75.00	25.00	47.00	0.05	2	4.000	9030110040000	9030210040000
5.000	5.000	75.00	30.00	47.00	0.05	2	5.000	9030110050000	9030210050000
6.000	6.000	75.00	30.00	39.00	0.05	2	6.000	9030110060000	9030210060000
8.000	8.000	100.00	40.00	64.00	0.10	2	8.000	9030110080000	9030210080000
10.000	10.000	100.00	40.00	60.00	0.10	2	10.000	9030110100000	9030210100000
12.000	12.000	150.00	45.00	105.00	0.10	2	12.000	9030110120000	9030210120000
14.000	14.000	150.00	45.00	105.00	0.15	2	14.000	9030110140000	9030210140000
14.000	16.000	150.00	65.00	102.00	0.15	2	14.001	9030110140010	9030210140010
16.000	16.000	150.00	65.00	102.00	0.15	2	16.000	9030110160000	9030210160000
18.000	18.000	150.00	65.00	102.00	0.15	2	18.000	9030110180000	9030210180000
18.000	20.000	150.00	65.00	100.00	0.15	2	18.001	9030110180010	9030210180010
20.000	20.000	150.00	65.00	100.00	0.15	2	20.000	9030110200000	9030210200000

# UNI-PRO End Mills (3-Flute) - Metric - Stub Length



## center cutting

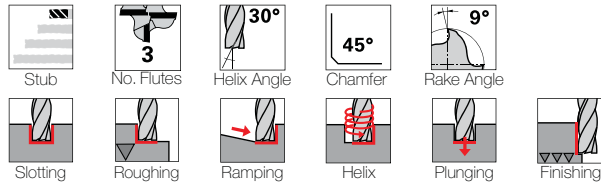

Tool material

Solid Carbide

Surface finish

FIREX®

Series

3558

3719

Application group	Material examples	Ideal for
P	Steel	●
M	Stainless steel	●
K	Cast iron	●
N	Aluminum	○
S	Ni / Ti alloys	○
H	Hardened steel	--

●=Optimal ○=Secondary

Speed and Feed data found on page 310

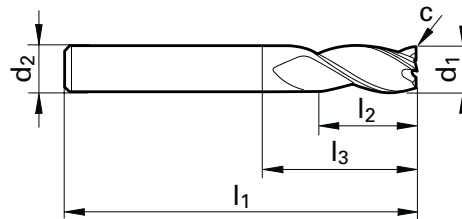

d1 h10	d2 h6	l1	l2	l3	c	No. of Flutes	Code no.	EDP Number	
mm	mm	mm	mm	mm	mm x 45°				
2.000	6.000	50.00	3.00	7.40	0.03	3	2.000	9035580020000	9037190020000
2.500	6.000	50.00	3.00	7.40	0.05	3	2.500	9035580025000	9037190025000
3.000	6.000	50.00	4.00	8.40	0.05	3	3.000	9035580030000	9037190030000
3.500	6.000	50.00	4.00	8.40	0.05	3	3.500	9035580035000	9037190035000
4.000	6.000	54.00	5.00	10.40	0.05	3	4.000	9035580040000	9037190040000
5.000	6.000	54.00	6.00	12.40	0.05	3	5.000	9035580050000	9037190050000
5.500	6.000	54.00	7.00	14.90	0.05	3	5.500	9035580055000	9037190055000
6.000	6.000	54.00	7.00	18.00	0.05	3	6.000	9035580060000	9037190060000
7.000	8.000	58.00	8.00	16.90	0.10	3	7.000	9035580070000	9037190070000
8.000	8.000	58.00	9.00	22.00	0.10	3	8.000	9035580080000	9037190080000
8.500	10.000	66.00	10.00	20.90	0.10	3	8.500	9035580085000	9037190085000
9.000	10.000	66.00	10.00	20.90	0.10	3	9.000	9035580090000	9037190090000
10.000	10.000	66.00	11.00	26.00	0.10	3	10.000	9035580100000	9037190100000
12.000	12.000	73.00	12.00	28.00	0.10	3	12.000	9035580120000	9037190120000
14.000	14.000	75.00	14.00	30.00	0.15	3	14.000	9035580140000	9037190140000
16.000	16.000	82.00	16.00	34.00	0.15	3	16.000	9035580160000	9037190160000
18.000	18.000	84.00	18.00	36.00	0.15	3	18.000	9035580180000	9037190180000
20.000	20.000	92.00	20.00	42.00	0.15	3	20.000	9035580200000	9037190200000

# UNI-PRO End Mills (3-Flute) - Inch - Standard Length



## center cutting

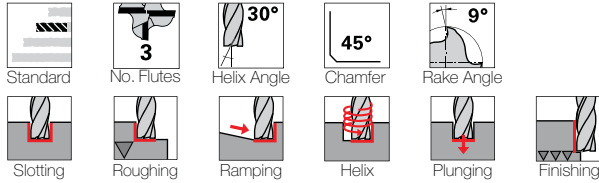

Tool material

**Solid Carbide**

Surface finish

bright

FIREX®

Series

**3168**

**3170**

Application group	Material examples	Ideal for
P	Steel	●
M	Stainless steel	●
K	Cast iron	●
N	Aluminum	●
S	Ni / Ti alloys	○
H	Hardened steel	--

●=Optimal    ○=Secondary

Speed and Feed data found on page 297

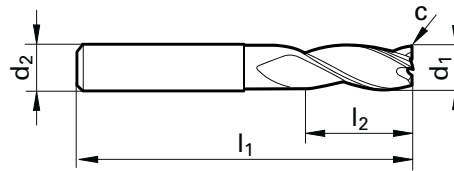

d1 h10	d2 h6	l1	l2	c	No. of Flutes	Code no.	EDP Number	
inch	inch	inch	inch	inch x 45°				
1/8	1/8	1 1/2	3/8	0.002	3	3.170	9031680031700	9031700031700
3/16	3/16	2	5/8	0.002	3	4.760	9031680047600	9031700047600
1/4	1/4	2 1/2	3/4	0.004	3	6.350	9031680063500	9031700063500
5/16	5/16	2 1/2	13/16	0.004	3	7.940	9031680079400	9031700079400
3/8	3/8	2 1/2	1	0.004	3	9.520	9031680095200	9031700095200
7/16	7/16	2 3/4	1	0.006	3	11.110	9031680111100	9031700111100
1/2	1/2	3	1	0.006	3	12.700	9031680127000	9031700127000
9/16	9/16	3 1/2	1 1/8	0.006	3	14.290	9031680142900	9031700142900
5/8	5/8	3 1/2	1 1/4	0.006	3	15.870	9031680158700	9031700158700
3/4	3/4	4	1 1/2	0.006	3	19.050	9031680190500	9031700190500
1	1	4	1 1/2	0.012	3	25.400	9031680254000	9031700254000

# UNI-PRO End Mills (3-Flute) - Metric - Standard Length



## center cutting



Standard



No. Flutes



Helix Angle



Chamfer



Rake Angle



Slotting



Roughing



Ramping



Helix



Plunging



Finishing

Tool material

Surface finish



HA



HA

Solid Carbide

bright

FIREX®

Series

3307

3677

Application group	Material examples	Ideal for
P	Steel	●
M	Stainless steel	●
K	Cast iron	●
N	Aluminum	●
S	Ni / Ti alloys	○
H	Hardened steel	--

●=Optimal ○=Secondary

Speed and Feed data found on page 310

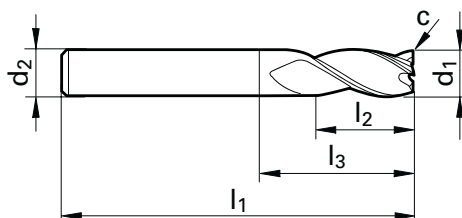

d1 h10	d2 h6	l1	l2	l3	c	No. of Flutes	Code no.	EDP Number	
mm	mm	mm	mm	mm	mm x 45°				
2.000	2.000	32.00	5.00	9.00	0.03	3	2.000	9033070020000	9036770020000
2.500	2.500	32.00	6.00	10.00	0.05	3	2.500	9033070025000	9036770025000
3.000	3.000	38.00	7.00	10.00	0.05	3	3.000	9033070030000	9036770030000
3.500	3.500	50.00	7.00	22.00	0.05	3	3.500	9033070035000	9036770035000
4.000	4.000	50.00	8.00	22.00	0.05	3	4.000	9033070040000	9036770040000
4.500	4.500	50.00	8.00	22.00	0.05	3	4.500	9033070045000	9036770045000
5.000	5.000	50.00	10.00	22.00	0.05	3	5.000	9033070050000	9036770050000
5.500	5.500	57.00	10.00	21.00	0.05	3	5.500	9033070055000	9036770055000
6.000	6.000	57.00	10.00	21.00	0.05	3	6.000	9033070060000	9036770060000
6.500	6.500	60.00	13.00	24.00	0.10	3	6.500	9033070065000	9036770065000
7.000	7.000	60.00	13.00	24.00	0.10	3	7.000	9033070070000	9036770070000
7.500	7.500	63.00	16.00	27.00	0.10	3	7.500	9033070075000	9036770075000
8.000	8.000	63.00	16.00	27.00	0.10	3	8.000	9033070080000	9036770080000
8.500	8.500	67.00	16.00	27.00	0.10	3	8.500	9033070085000	9036770085000
9.000	9.000	67.00	16.00	27.00	0.10	3	9.000	9033070090000	9036770090000
9.500	9.500	72.00	19.00	32.00	0.10	3	9.500	9033070095000	9036770095000
10.000	10.000	72.00	19.00	32.00	0.10	3	10.000	9033070100000	9036770100000
11.000	11.000	83.00	22.00	38.00	0.10	3	11.000	9033070110000	9036770110000
12.000	12.000	83.00	22.00	38.00	0.10	3	12.000	9033070120000	9036770120000
13.000	13.000	83.00	22.00	38.00	0.15	3	13.000	9033070130000	9036770130000
14.000	14.000	83.00	22.00	38.00	0.15	3	14.000	9033070140000	9036770140000
15.000	15.000	92.00	26.00	44.00	0.15	3	15.000	9033070150000	9036770150000
16.000	16.000	92.00	26.00	44.00	0.15	3	16.000	9033070160000	9036770160000
18.000	18.000	92.00	26.00	44.00	0.15	3	18.000	9033070180000	9036770180000
20.000	20.000	104.00	32.00	54.00	0.15	3	20.000	9033070200000	9036770200000



# UNI-PRO End Mills (3-Flute) - Inch - XL Long Length



## center cutting



Tool material

**Solid Carbide**

Surface finish

bright

FIREX®

Series

**3169**

**3171**

Application group	Material examples	Ideal for
P	Steel	●
M	Stainless steel	●
K	Cast iron	●
N	Aluminum	●
S	Ni / Ti alloys	○
H	Hardened steel	--

●=Optimal    ○=Secondary

Speed and Feed data found on page 297

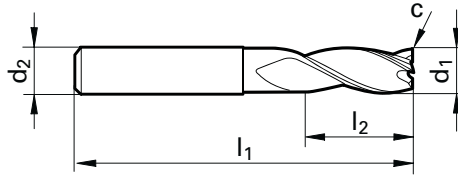

d1 h10	d2 h6	l1	l2	c	No. of Flutes	Code no.	EDP Number	
inch	inch	inch	inch	inch x 45°				
3/16	3/16	3	1 1/4	0.002	3	4.760	9031690047600	9031710047600
1/4	1/4	4	1 5/8	0.004	3	6.350	9031690063500	9031710063500
5/16	5/16	4	1 5/8	0.004	3	7.940	9031690079400	9031710079400
3/8	3/8	4	1 5/8	0.004	3	9.520	9031690095200	9031710095200
7/16	7/16	5	2	0.006	3	11.110	9031690111100	9031710111100
1/2	1/2	6	3	0.006	3	12.700	9031690127000	9031710127000
5/8	5/8	6	3	0.006	3	15.870	9031690158700	9031710158700
3/4	3/4	6	3	0.006	3	19.050	9031690190500	9031710190500
1	1	6	3	0.012	3	25.400	9031690254000	9031710254000

# UNI-PRO End Mills (3-Flute) - Metric - XL Long Length



## center cutting



Tool material

**Solid Carbide**

Surface finish

FIREX®

FIREX®

Series

**3314**

**3680**

Application group	Material examples	Ideal for
<b>P</b>	Steel	●
<b>M</b>	Stainless steel	●
<b>K</b>	Cast iron	●
<b>N</b>	Aluminum	●
<b>S</b>	Ni / Ti alloys	○
<b>H</b>	Hardened steel	--

●=Optimal    ○=Secondary

Speed and Feed data found on page 310

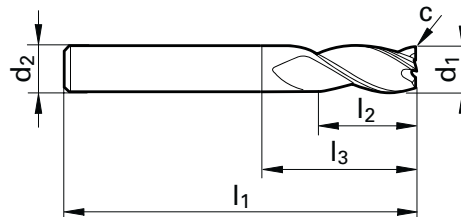

d1 h10	d2 h6	l1	l2	l3	c	No. of Flutes	Code no.	EDP Number	
mm	mm	mm	mm	mm	mm x 45°				
3.000	3.000	75.00	20.00	47.00	0.05	3	3.000	9033140030000	9036800030000
4.000	4.000	75.00	25.00	47.00	0.05	3	4.000	9033140040000	9036800040000
5.000	5.000	75.00	30.00	47.00	0.05	3	5.000	9033140050000	9036800050000
6.000	6.000	75.00	30.00	39.00	0.05	3	6.000	9033140060000	9036800060000
8.000	8.000	100.00	40.00	64.00	0.10	3	8.000	9033140080000	9036800080000
10.000	10.000	100.00	40.00	60.00	0.10	3	10.000	9033140100000	9036800100000
12.000	12.000	150.00	45.00	105.00	0.10	3	12.000	9033140120000	9036800120000
16.000	16.000	150.00	65.00	102.00	0.15	3	16.000	9033140160000	9036800160000
20.000	20.000	150.00	65.00	100.00	0.15	3	20.000	9033140200000	9036800200000

# UNI-PRO End Mills (4-Flute) - Inch - Stub Length



## center cutting



Stub



No. Flutes



Helix Angle



Chamfer



Rake Angle



Slotting



Roughing



Ramping



Helix



Finishing



Tool material

**Solid Carbide**

Surface finish

FIREX®

Series

**3093**

Application group	Material examples	Ideal for
<b>P</b>	Steel	●
<b>M</b>	Stainless steel	●
<b>K</b>	Cast iron	●
<b>N</b>	Aluminum	○
<b>S</b>	Ni / Ti alloys	○
<b>H</b>	Hardened steel	--

●=Optimal    ○=Secondary

Speed and Feed data found on page 297

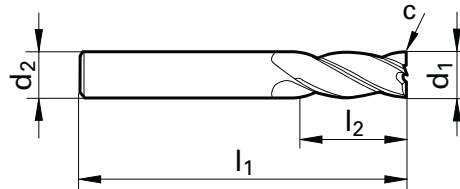

d1 h10	d2 h6	l1	l2	c	No. of Flutes	Code no.	EDP Number
inch	inch	inch	inch	inch x 45°			
1/16	1/8	2	1/8	0.001	4	1.590	9030930015900
1/8	1/8	2	1/4	0.002	4	3.170	9030930031700
3/16	3/16	2	3/8	0.002	4	4.760	9030930047600
1/4	1/4	2	1/2	0.004	4	6.350	9030930063500
5/16	5/16	2	1/2	0.004	4	7.940	9030930079400
3/8	3/8	2	5/8	0.004	4	9.520	9030930095200
7/16	7/16	2 1/2	5/8	0.006	4	11.110	9030930111100
1/2	1/2	2 1/2	5/8	0.006	4	12.700	9030930127000
5/8	5/8	3	3/4	0.006	4	15.870	9030930158700
3/4	3/4	3	1	0.006	4	19.050	9030930190500

# UNI-PRO End Mills (4-Flute) - Metric - Stub Length



## center cutting

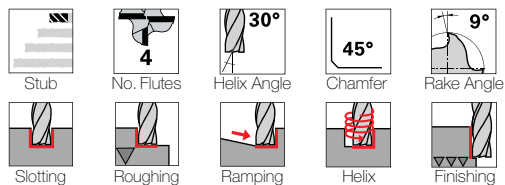

Tool material

Solid Carbide

Surface finish

FIREX®

Series

3637

3721

Application group	Material examples	Ideal for
P	Steel	●
M	Stainless steel	●
K	Cast iron	●
N	Aluminum	○
S	Ni / Ti alloys	○
H	Hardened steel	--

●=Optimal ○=Secondary

Speed and Feed data found on page 310

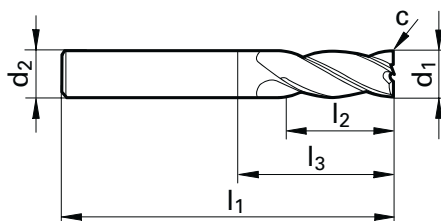

d1 h10	d2 h6	l1	l2	l3	c	No. of Flutes	Code no.	EDP Number	
mm	mm	mm	mm	mm	mm x 45°				
2.000	6.000	50.00	4.00	8.40	0.03	4	2.000	9036370020000	9037210020000
3.000	6.000	50.00	5.00	9.40	0.05	4	3.000	9036370030000	9037210030000
4.000	6.000	54.00	8.00	13.40	0.05	4	4.000	9036370040000	9037210040000
5.000	6.000	54.00	9.00	15.90	0.05	4	5.000	9036370050000	9037210050000
6.000	6.000	54.00	10.00	18.00	0.05	4	6.000	9036370060000	9037210060000
8.000	8.000	58.00	12.00	22.00	0.10	4	8.000	9036370080000	9037210080000
10.000	10.000	66.00	14.00	26.00	0.10	4	10.000	9036370100000	9037210100000
12.000	12.000	73.00	16.00	28.00	0.10	4	12.000	9036370120000	9037210120000
14.000	14.000	75.00	18.00	30.00	0.15	4	14.000	9036370140000	9037210140000
16.000	16.000	82.00	22.00	34.00	0.15	4	16.000	9036370160000	9037210160000
18.000	18.000	84.00	24.00	36.00	0.15	4	18.000	9036370180000	9037210180000
20.000	20.000	92.00	26.00	42.00	0.15	4	20.000	9036370200000	9037210200000

# UNI-PRO End Mills (4-Flute) - Inch - Standard Length



## center cutting

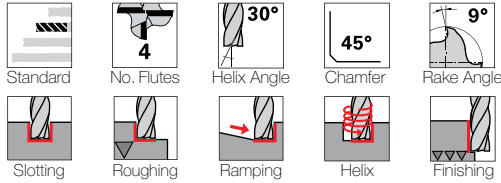

Tool material

**Solid Carbide**

Surface finish

bright

FIREX®

Series

**3150**

**3153**

Application group	Material examples	Ideal for
P	Steel	●
M	Stainless steel	●
K	Cast iron	●
N	Aluminum	●
S	Ni / Ti alloys	○
H	Hardened steel	--

●=Optimal    ○=Secondary

Speed and Feed data found on page 297

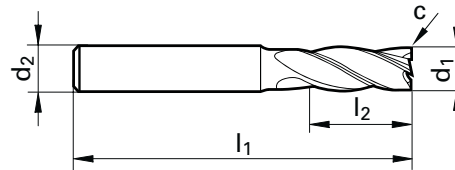

d1 h10	d2 h6	l1	l2	c	No. of Flutes	Code no.	EDP Number	
inch	inch	inch	inch	inch x 45°				
1/16	1/8	1 1/2	3/16	0.001	4	1.590	9031500015900	9031530015900
5/64	1/8	1 1/2	9/32	0.001	4	1.980	9031500019800	9031530019800
3/32	1/8	1 1/2	9/32	0.002	4	2.380	9031500023800	9031530023800
7/64	1/8	1 1/2	3/8	0.002	4	2.780	9031500027800	9031530027800
1/8	1/8	1 1/2	3/8	0.002	4	3.170	9031500031700	9031530031700
9/64	3/16	2	1/2	0.002	4	3.570	9031500035700	9031530035700
5/32	3/16	2	1/2	0.002	4	3.970	9031500039700	9031530039700
11/64	3/16	2	5/8	0.002	4	4.370	9031500043700	9031530043700
3/16	3/16	2	5/8	0.002	4	4.760	9031500047600	9031530047600
13/64	1/4	2 1/2	5/8	0.002	4	5.160	9031500051600	9031530051600
7/32	1/4	2 1/2	5/8	0.002	4	5.560	9031500055600	9031530055600
15/64	1/4	2 1/2	3/4	0.002	4	5.950	9031500059500	9031530059500
1/4	1/4	2 1/2	3/4	0.004	4	6.350	9031500063500	9031530063500
17/64	5/16	2 1/2	3/4	0.004	4	6.750	9031500067500	9031530067500
9/32	5/16	2 1/2	3/4	0.004	4	7.140	9031500071400	9031530071400
19/64	5/16	2 1/2	13/16	0.004	4	7.540	9031500075400	9031530075400
5/16	5/16	2 1/2	13/16	0.004	4	7.940	9031500079400	9031530079400
21/64	3/8	2 1/2	1	0.004	4	8.330	9031500083300	9031530083300
11/32	3/8	2 1/2	1	0.004	4	8.730	9031500087300	9031530087300
23/64	3/8	2 1/2	1	0.004	4	9.130	9031500091300	9031530091300
3/8	3/8	2 1/2	1	0.004	4	9.520	9031500095200	9031530095200
25/64	7/16	2 1/2	1	0.004	4	9.920	9031500099200	9031530099200
13/32	7/16	2 3/4	1	0.006	4	10.320	9031500103200	9031530103200
27/64	7/16	2 3/4	1	0.006	4	10.720	9031500107200	9031530107200
7/16	7/16	2 3/4	1	0.006	4	11.110	9031500111100	9031530111100
29/64	1/2	3	1	0.006	4	11.510	9031500115100	9031530115100
15/32	1/2	3	1	0.006	4	11.910	9031500119100	9031530119100
31/64	1/2	3	1	0.006	4	12.300	9031500123000	9031530123000
1/2	1/2	3	1	0.006	4	12.700	9031500127000	9031530127000
9/16	9/16	3 1/2	1 1/8	0.006	4	14.290	9031500142900	9031530142900
5/8	5/8	3 1/2	1 1/4	0.006	4	15.870	9031500158700	9031530158700
11/16	3/4	4	1 3/8	0.006	4	17.460	9031500174600	9031530174600
3/4	3/4	4	1 1/2	0.006	4	19.050	9031500190500	9031530190500
1	1	4	1 1/2	0.012	6	25.400	9031500254000	9031530254000

# UNI-PRO "R" End Mills (4-Flute) - Inch - Standard Length



center cutting with corner radius

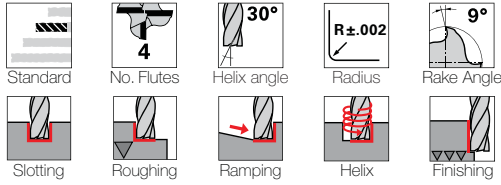

Tool material

**Solid Carbide**

Surface finish

FIREX®

Series

**3089**

Application group	Material examples	Ideal for
<b>P</b>	Steel	●
<b>M</b>	Stainless steel	●
<b>K</b>	Cast iron	●
<b>N</b>	Aluminum	○
<b>S</b>	Ni / Ti alloys	○
<b>H</b>	Hardened steel	--

●=Optimal    ○=Secondary

Speed and Feed data found on page 297

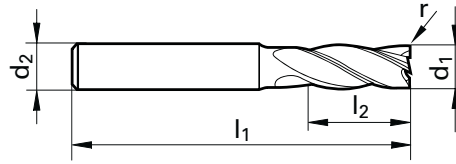

d1 h10	d2 h6	l1	l2	r	No. of Flutes	Code no.	EDP Number
inch	inch	inch	inch				
1/8	1/8	1 1/2	3/8	0.015	4	3.172	9030890031720
1/8	1/8	1 1/2	3/8	0.031	4	3.174	9030890031740
3/16	3/16	2	5/8	0.015	4	4.762	9030890047620
3/16	3/16	2	5/8	0.031	4	4.764	9030890047640
3/16	3/16	2	5/8	0.062	4	4.766	9030890047660
1/4	1/4	2 1/2	3/4	0.015	4	6.352	9030890063520
1/4	1/4	2 1/2	3/4	0.031	4	6.354	9030890063540
1/4	1/4	2 1/2	3/4	0.062	4	6.356	9030890063560
5/16	5/16	2 1/2	13/16	0.015	4	7.942	9030890079420
5/16	5/16	2 1/2	13/16	0.031	4	7.944	9030890079440
5/16	5/16	2 1/2	13/16	0.062	4	7.946	9030890079460
3/8	3/8	2 1/2	1	0.015	4	9.522	9030890095220
3/8	3/8	2 1/2	1	0.031	4	9.524	9030890095240
3/8	3/8	2 1/2	1	0.062	4	9.526	9030890095260
1/2	1/2	3	1	0.015	4	12.702	9030890127020
1/2	1/2	3	1	0.031	4	12.704	9030890127040
1/2	1/2	3	1	0.062	4	12.706	9030890127060

# UNI-PRO End Mills (4-Flute) - Metric - Standard Length



## center cutting

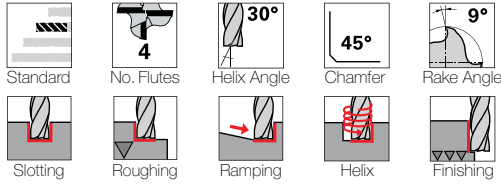

Tool material

**Solid Carbide**

Surface finish

bright

FIREX®

Series

**3304**

**3678**

Application group	Material examples	Ideal for
P	Steel	●
M	Stainless steel	●
K	Cast iron	●
N	Aluminum	●
S	Ni / Ti alloys	○
H	Hardened steel	--

●=Optimal    ○=Secondary

Speed and Feed data found on page 310

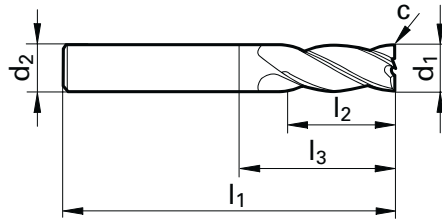

d1 h10	d2 h6	l1	l2	l3	c	No. of Flutes	Code no.	EDP Number	
mm	mm	mm	mm	mm	mm x 45°				
2.000	2.000	32.00	5.00	10.00	0.03	4	2.000	9033040020000	9036780020000
2.500	2.500	32.00	6.00	11.00	0.05	4	2.500	9033040025000	9036780025000
3.000	3.000	38.00	7.00	11.00	0.05	4	3.000	9033040030000	9036780030000
3.500	3.500	50.00	8.00	14.00	0.05	4	3.500	9033040035000	9036780035000
4.000	4.000	50.00	11.00	22.00	0.05	4	4.000	9033040040000	9036780040000
4.500	4.500	50.00	11.00	22.00	0.05	4	4.500	9033040045000	9036780045000
5.000	5.000	50.00	13.00	22.00	0.05	4	5.000	9033040050000	9036780050000
6.000	6.000	57.00	13.00	21.00	0.05	4	6.000	9033040060000	9036780060000
7.000	7.000	60.00	16.00	24.00	0.10	4	7.000	9033040070000	9036780070000
7.500	7.500	63.00	19.00	27.00	0.10	4	7.500	9033040075000	9036780075000
8.000	8.000	63.00	19.00	27.00	0.10	4	8.000	9033040080000	9036780080000
9.000	9.000	67.00	19.00	27.00	0.10	4	9.000	9033040090000	9036780090000
10.000	10.000	72.00	22.00	32.00	0.10	4	10.000	9033040100000	9036780100000
11.000	11.000	83.00	26.00	38.00	0.10	4	11.000	9033040110000	9036780110000
12.000	12.000	83.00	26.00	38.00	0.10	4	12.000	9033040120000	9036780120000
13.000	13.000	83.00	26.00	38.00	0.15	4	13.000	9033040130000	9036780130000
14.000	14.000	83.00	26.00	38.00	0.15	4	14.000	9033040140000	9036780140000
15.000	15.000	92.00	32.00	44.00	0.15	4	15.000	9033040150000	
16.000	16.000	92.00	32.00	44.00	0.15	4	16.000	9033040160000	9036780160000
18.000	18.000	92.00	32.00	44.00	0.15	4	18.000	9033040180000	9036780180000
20.000	20.000	104.00	38.00	54.00	0.15	4	20.000	9033040200000	9036780200000

# UNI-PRO "R" End Mills (4-Flute) - Metric - Standard Length



center cutting with corner radius

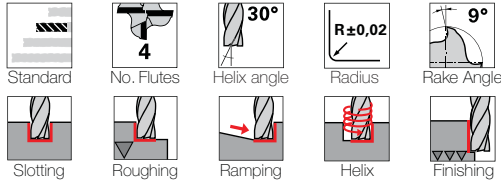

Tool material

Solid Carbide

Surface finish

bright

FIREX®

Series

3111

3562

Application group	Material examples	Ideal for
P	Steel	●
M	Stainless steel	●
K	Cast iron	●
N	Aluminum	●
S	Ni / Ti alloys	○
H	Hardened steel	--

●=Optimal ○=Secondary

Speed and Feed data found on page 310

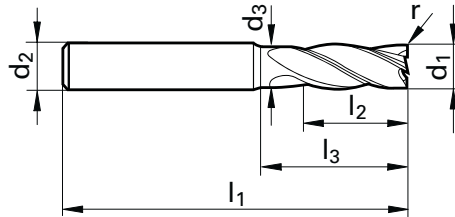

d1 h10	d2 h6	d3	l1	l2	l3	r	No. of Flutes	Code no.	EDP Number	
mm	mm	mm	mm	mm	mm					
6.000	6.000	5.700	57.00	13.00	20.00	0.50	4	6.005	9031110060050	9035620060050
6.000	6.000	5.700	57.00	13.00	20.00	1.00	4	6.010	9031110060100	9035620060100
8.000	8.000	7.700	63.00	19.00	26.00	0.50	4	8.005	9031110080050	9035620080050
8.000	8.000	7.700	63.00	19.00	26.00	1.00	4	8.010	9031110080100	9035620080100
8.000	8.000	7.700	63.00	19.00	26.00	1.50	4	8.015	9031110080150	9035620080150
8.000	8.000	7.700	63.00	19.00	26.00	2.00	4	8.020	9031110080200	9035620080200
10.000	10.000	9.500	72.00	22.00	30.00	0.50	4	10.005	9031110100050	9035620100050
10.000	10.000	9.500	72.00	22.00	30.00	0.80	4	10.008	9031110100080	9035620100080
10.000	10.000	9.500	72.00	22.00	30.00	1.00	4	10.010	9031110100100	9035620100100
10.000	10.000	9.500	72.00	22.00	30.00	1.50	4	10.015	9031110100150	9035620100150
10.000	10.000	9.500	72.00	22.00	30.00	2.00	4	10.020	9031110100200	9035620100200
12.000	12.000	11.500	83.00	26.00	36.00	0.50	4	12.005	9031110120050	9035620120050
12.000	12.000	11.500	83.00	26.00	36.00	0.80	4	12.008	9031110120080	9035620120080
12.000	12.000	11.500	83.00	26.00	36.00	1.00	4	12.010	9031110120100	9035620120100
12.000	12.000	11.500	83.00	26.00	36.00	1.50	4	12.015	9031110120150	9035620120150
12.000	12.000	11.500	83.00	26.00	36.00	2.00	4	12.020	9031110120200	9035620120200
16.000	16.000	15.500	92.00	32.00	42.00	1.00	4	16.010	9031110160100	9035620160100
16.000	16.000	15.500	92.00	32.00	42.00	1.50	4	16.015	9031110160150	9035620160150
16.000	16.000	15.500	92.00	32.00	42.00	2.00	4	16.020	9031110160200	9035620160200
20.000	20.000	19.500	104.00	38.00	52.00	1.00	4	20.010	9031110200100	9035620200100
20.000	20.000	19.500	104.00	38.00	52.00	1.50	4	20.015	9031110200150	9035620200150
20.000	20.000	19.500	104.00	38.00	52.00	2.00	4	20.020	9031110200200	9035620200200



# UNI-PRO End Mills (4-Flute) - Inch - Long Length



## center cutting

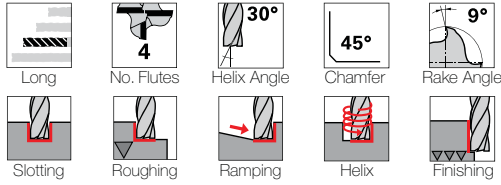

Tool material

**Solid Carbide**

Surface finish

bright

FIREX®

Series

**3152**

**3156**

Application group	Material examples	Ideal for
P	Steel	●
M	Stainless steel	●
K	Cast iron	●
N	Aluminum	●
S	Ni / Ti alloys	○
H	Hardened steel	--

●=Optimal ○=Secondary

Speed and Feed data found on page 297

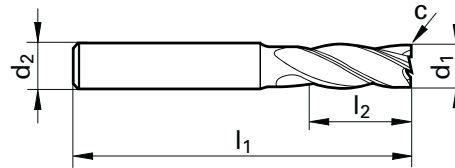

d1 h10	d2 h6	l1	l2	c	No. of Flutes	Code no.	EDP Number	
inch	inch	inch	inch	inch x 45°				
1/8	1/8	2	1/2	0.002	4	3.170	9031520031700	9031560031700
3/16	3/16	2 1/2	3/4	0.002	4	4.760	9031520047600	9031560047600
1/4	1/4	3	1 1/8	0.004	4	6.350	9031520063500	9031560063500
5/16	5/16	3	1 1/8	0.004	4	7.940	9031520079400	9031560079400
3/8	3/8	3	1 1/8	0.004	4	9.520	9031520095200	9031560095200
7/16	7/16	4 1/2	2	0.006	4	11.110	9031520111100	9031560111100
1/2	1/2	4 1/2	2	0.006	4	12.700	9031520127000	9031560127000
5/8	5/8	5	2 1/4	0.006	4	15.870	9031520158700	9031560158700
3/4	3/4	5	2 1/4	0.006	4	19.050	9031520190500	9031560190500
1	1	5	2 1/4	0.012	6	25.400	9031520254000	9031560254000

# UNI-PRO End Mills (4-Flute) - Inch - XL Long Length



## center cutting



Tool material

**Solid Carbide**

Surface finish

bright

FIREX®

Series

**3151**

**3155**

Application group	Material examples	Ideal for
<b>P</b>	Steel	●
<b>M</b>	Stainless steel	●
<b>K</b>	Cast iron	●
<b>N</b>	Aluminum	●
<b>S</b>	Ni / Ti alloys	○
<b>H</b>	Hardened steel	--

●=Optimal    ○=Secondary

Speed and Feed data found on page 297

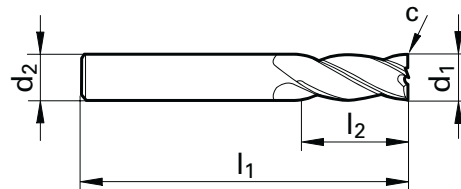

d1 h10	d2 h6	l1	l2	c	No. of Flutes	Code no.	EDP Number	
inch	inch	inch	inch	inch x 45°				
3/16	3/16	3	1 1/4	0.002	4	4.760	9031510047600	9031550047600
1/4	1/4	4	1 5/8	0.004	4	6.350	9031510063500	9031550063500
5/16	5/16	4	1 5/8	0.004	4	7.940	9031510079400	9031550079400
3/8	3/8	4	1 5/8	0.004	4	9.520	9031510095200	9031550095200
7/16	7/16	5	2	0.006	4	11.110	9031510111100	9031550111100
1/2	1/2	6	3	0.006	4	12.700	9031510127000	9031550127000
5/8	5/8	6	3	0.006	4	15.870	9031510158700	9031550158700
3/4	3/4	6	3	0.006	4	19.050	9031510190500	9031550190500
1	1	6	3	0.012	6	25.400	9031510254000	9031550254000

# UNI-PRO "R" End Mills (4-Flute) - Inch - XL Long Length



center cutting with corner radius



XL Long



No. Flutes



Helix angle



Radius



Rake Angle



Roughing



Ramping



Helix



Finishing

Tool material

Surface finish



Solid Carbide

FIREX®

Series

3090

Application group	Material examples	Ideal for
P	Steel	●
M	Stainless steel	●
K	Cast iron	●
N	Aluminum	○
S	Ni / Ti alloys	○
H	Hardened steel	--

●=Optimal    ○=Secondary

Speed and Feed data found on page 297

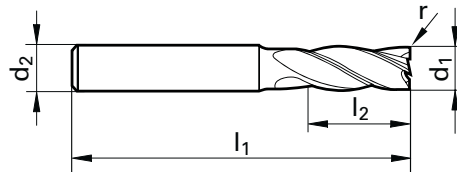

d1 h10	d2 h6	l1	l2	r	No. of Flutes	Code no.	EDP Number
inch	inch	inch	inch				
1/4	1/4	4	1 5/8	0.015	4	6.352	9030900063520
1/4	1/4	4	1 5/8	0.031	4	6.354	9030900063540
1/4	1/4	4	1 5/8	0.062	4	6.356	9030900063560
3/8	3/8	4	1 5/8	0.015	4	9.522	9030900095220
3/8	3/8	4	1 5/8	0.031	4	9.524	9030900095240
3/8	3/8	4	1 5/8	0.062	4	9.526	9030900095260
1/2	1/2	6	3	0.015	4	12.702	9030900127020
1/2	1/2	6	3	0.031	4	12.704	9030900127040
1/2	1/2	6	3	0.062	4	12.706	9030900127060

# UNI-PRO End Mills (4-Flute) - Metric - XL Long Length



## center cutting



Tool material

**Solid Carbide**

Surface finish

bright

FIREX®

Series

**3012**

**3023**

Application group	Material examples	Ideal for
P	Steel	●
M	Stainless steel	●
K	Cast iron	●
N	Aluminum	●
S	Ni / Ti alloys	○
H	Hardened steel	--

●=Optimal ○=Secondary

Speed and Feed data found on page 310

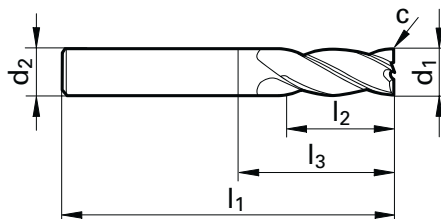

d1 h10	d2 h6	l1	l2	l3	c	No. of Flutes	Code no.	EDP Number	
mm	mm	mm	mm	mm	mm x 45°				
3.000	3.000	75.00	20.00	47.00	0.05	4	3.000	9030120030000	9030230030000
4.000	4.000	75.00	25.00	47.00	0.05	4	4.000	9030120040000	9030230040000
5.000	5.000	75.00	30.00	47.00	0.05	4	5.000	9030120050000	9030230050000
6.000	6.000	75.00	30.00	39.00	0.05	4	6.000	9030120060000	9030230060000
8.000	8.000	100.00	40.00	64.00	0.10	4	8.000	9030120080000	9030230080000
10.000	10.000	100.00	40.00	60.00	0.10	4	10.000	9030120100000	9030230100000
12.000	12.000	150.00	45.00	105.00	0.10	4	12.000	9030120120000	9030230120000
14.000	14.000	150.00	45.00	105.00	0.15	4	14.000	9030120140000	9030230140000
14.000	16.000	150.00	65.00	101.00	0.15	4	14.001	9030120140010	9030230140010
16.000	16.000	150.00	65.00	102.00	0.15	4	16.000	9030120160000	9030230160000
18.000	18.000	150.00	65.00	102.00	0.15	4	18.000	9030120180000	9030230180000
18.000	20.000	150.00	65.00	99.00	0.15	4	18.001	9030120180010	9030230180010
20.000	20.000	150.00	65.00	100.00	0.15	4	20.000	9030120200000	9030230200000

# UNI-PRO Ball Nose (2-Flute) - Inch - Standard Length



## center cutting

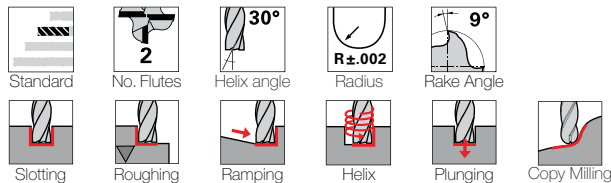

Tool material

Solid Carbide

Surface finish

bright

FIREX®

Series

3157

3159

Application group	Material examples	Ideal for
P	Steel	●
M	Stainless steel	●
K	Cast iron	●
N	Aluminum	●
S	Ni / Ti alloys	○
H	Hardened steel	--

●=Optimal    ○=Secondary

Speed and Feed data found on page 297

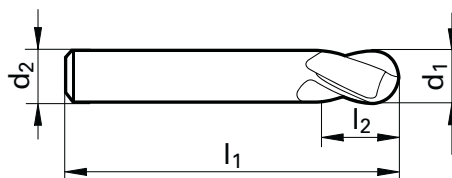

d1 h10	d2 h6	l1	l2	No. of Flutes	Code no.	EDP Number	
inch	inch	inch	inch				
1/16	1/8	1 1/2	3/16	2	1.590	9031570015900	9031590015900
5/64	1/8	1 1/2	9/32	2	1.980	9031570019800	9031590019800
3/32	1/8	1 1/2	1/4	2	2.380	9031570023800	9031590023800
7/64	1/8	1 1/2	3/8	2	2.780	9031570027800	9031590027800
1/8	1/8	1 1/2	3/8	2	3.170	9031570031700	9031590031700
9/64	3/16	2	1/2	2	3.570	9031570035700	9031590035700
5/32	3/16	2	1/2	2	3.970	9031570039700	9031590039700
11/64	3/16	2	5/8	2	4.370	9031570043700	9031590043700
3/16	3/16	2	5/8	2	4.760	9031570047600	9031590047600
13/64	1/4	2 1/2	5/8	2	5.160	9031570051600	9031590051600
7/32	1/4	2 1/2	5/8	2	5.560	9031570055600	9031590055600
15/64	1/4	2 1/2	3/4	2	5.950	9031570059500	9031590059500
1/4	1/4	2 1/2	3/4	2	6.350	9031570063500	9031590063500
17/64	5/16	2 1/2	3/4	2	6.750	9031570067500	9031590067500
9/32	5/16	2 1/2	3/4	2	7.140	9031570071400	9031590071400
19/64	5/16	2 1/2	13/16	2	7.540	9031570075400	9031590075400
5/16	5/16	2 1/2	13/16	2	7.940	9031570079400	9031590079400
21/64	3/8	2 1/2	13/16	2	8.330	9031570083300	9031590083300
11/32	3/8	2 1/2	1	2	8.730	9031570087300	9031590087300
23/64	3/8	2 1/2	1	2	9.130	9031570091300	9031590091300
3/8	3/8	2 1/2	1	2	9.520	9031570095200	9031590095200
25/64	7/16	2 3/4	1	2	9.920	9031570099200	9031590099200
13/32	7/16	2 3/4	1	2	10.320	9031570103200	9031590103200
27/64	7/16	2 3/4	1	2	10.720	9031570107200	9031590107200
7/16	7/16	2 3/4	1	2	11.110	9031570111100	9031590111100
29/64	1/2	3	1	2	11.510	9031570115100	9031590115100
15/32	1/2	3	1	2	11.910	9031570119100	9031590119100
31/64	1/2	3	1	2	12.300	9031570123000	9031590123000
1/2	1/2	3	1	2	12.700	9031570127000	9031590127000
9/16	9/16	3 1/2	1 1/8	2	14.290	9031570142900	9031590142900
5/8	5/8	3 1/2	1 1/4	2	15.870	9031570158700	9031590158700
3/4	3/4	4	1 1/2	2	19.050	9031570190500	9031590190500
1	1	4	1 1/2	2	25.400	9031570254000	9031590254000

# UNI-PRO Ball Nose (2-Flute) - Metric - Standard Length



## center cutting



Standard



No. Flutes



Helix angle



Radius



Rake Angle



Slotting



Roughing



Ramping



Helix



Plunging



Copy Milling

Tool material

Surface finish



HA



HB

Solid Carbide

bright

bright

Series

3308

3024

Application group	Material examples	Ideal for
P	Steel	○
M	Stainless steel	--
K	Cast iron	--
N	Aluminum	●
S	Ni / Ti alloys	--
H	Hardened steel	--

●=Optimal ○=Secondary

Speed and Feed data found on page 310

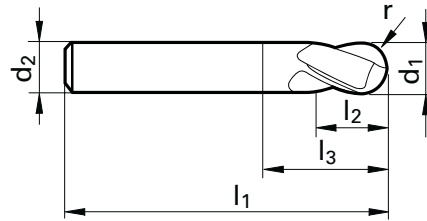

d1 h10	d2 h6	l1	l2	l3	No. of Flutes	Code no.	EDP Number
mm	mm	mm	mm	mm			
0.500	3.000	38.00	1.00	2.10	2	0.500	9033080005000
0.800	3.000	38.00	1.00	2.10	2	0.800	9033080008000
1.000	3.000	38.00	2.00	3.90	2	1.000	9033080010000
1.500	3.000	38.00	3.00	6.40	2	1.500	9033080015000
2.000	6.000	57.00	6.00	9.40	2	2.000	9033080020000
3.000	6.000	57.00	7.00	11.90	2	3.000	9033080030000 9030240030000
4.000	6.000	57.00	8.00	13.40	2	4.000	9033080040000 9030240040000
5.000	6.000	57.00	10.00	16.90	2	5.000	9033080050000 9030240050000
6.000	6.000	57.00	10.00	21.00	2	6.000	9033080060000 9030240060000
8.000	8.000	63.00	16.00	27.00	2	8.000	9033080080000 9030240080000
10.000	10.000	72.00	19.00	32.00	2	10.000	9033080100000 9030240100000
12.000	12.000	83.00	22.00	38.00	2	12.000	9033080120000 9030240120000
14.000	14.000	83.00	22.00	38.00	2	14.000	9033080140000 9030240140000
16.000	16.000	92.00	26.00	44.00	2	16.000	9033080160000 9030240160000
18.000	18.000	92.00	26.00	44.00	2	18.000	9033080180000 9030240180000
20.000	20.000	104.00	32.00	54.00	2	20.000	9033080200000 9030240200000

# UNI-PRO Ball Nose (2-Flute) - Metric - Standard Length



## center cutting

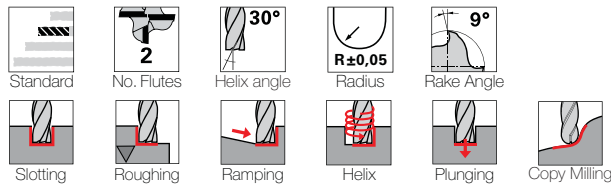

Tool material

**Solid Carbide**

Surface finish

FIREX®

FIREX®

Series

**3679**

**3049**

Application group	Material examples	Ideal for
P	Steel	●
M	Stainless steel	●
K	Cast iron	●
N	Aluminum	○
S	Ni / Ti alloys	○
H	Hardened steel	--

●=Optimal ○=Secondary

Speed and Feed data found on page 310

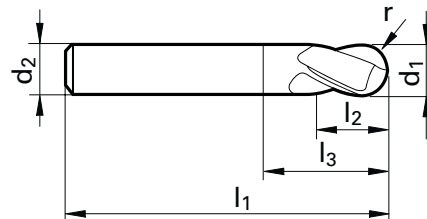

d1 h10	d2 h6	l1	l2	l3	No. of Flutes	Code no.	EDP Number
mm	mm	mm	mm	mm			
0.500	3.000	38.00	1.00	2.10	2	0.500	9036790005000
0.800	3.000	38.00	1.00	2.10	2	0.800	9036790008000
1.000	3.000	38.00	2.00	3.90	2	1.000	9036790010000
1.500	3.000	38.00	3.00	6.40	2	1.500	9036790015000
2.000	6.000	57.00	6.00	9.40	2	2.000	9036790020000
3.000	6.000	57.00	7.00	11.90	2	3.000	9036790030000 9030490030000
4.000	6.000	57.00	8.00	13.40	2	4.000	9036790040000 9030490040000
5.000	6.000	57.00	10.00	16.90	2	5.000	9036790050000 9030490050000
6.000	6.000	57.00	10.00	21.00	2	6.000	9036790060000 9030490060000
8.000	8.000	63.00	16.00	27.00	2	8.000	9036790080000 9030490080000
10.000	10.000	72.00	19.00	32.00	2	10.000	9036790100000 9030490100000
12.000	12.000	83.00	22.00	38.00	2	12.000	9036790120000 9030490120000
14.000	14.000	83.00	22.00	38.00	2	14.000	9036790140000 9030490140000
16.000	16.000	92.00	26.00	44.00	2	16.000	9036790160000 9030490160000
18.000	18.000	92.00	26.00	44.00	2	18.000	9036790180000 9030490180000
20.000	20.000	104.00	32.00	54.00	2	20.000	9036790200000 9030490200000

# UNI-PRO Ball Nose (2-Flute) - Inch - Long Length



## center cutting

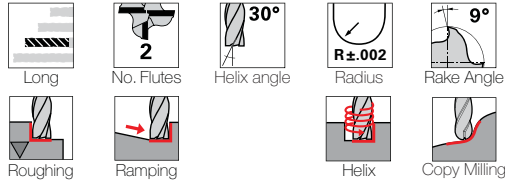

Tool material

**Solid Carbide**

Surface finish

bright

FIREX®

Series

**3158**

**3160**

Application group	Material examples	Ideal for
<b>P</b>	Steel	●
<b>M</b>	Stainless steel	●
<b>K</b>	Cast iron	●
<b>N</b>	Aluminum	●
<b>S</b>	Ni / Ti alloys	○
<b>H</b>	Hardened steel	--

●=Optimal    ○=Secondary

Speed and Feed data found on page 297

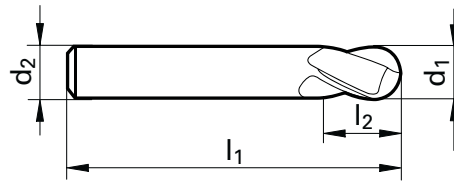

d1 h10	d2 h6	l1	l2	No. of Flutes	Code no.	EDP Number	
inch	inch	inch	inch				
1/8	1/8	2	1/2	2	3.170	9031580031700	9031600031700
3/16	3/16	2 1/2	3/4	2	4.760	9031580047600	9031600047600
1/4	1/4	3	1 1/8	2	6.350	9031580063500	9031600063500
5/16	5/16	3	1 1/8	2	7.940	9031580079400	9031600079400
3/8	3/8	3	1 1/8	2	9.520	9031580095200	9031600095200
7/16	7/16	4 1/2	2	2	11.110	9031580111100	9031600111100
1/2	1/2	4 1/2	2	2	12.700	9031580127000	9031600127000
5/8	5/8	5	2 1/4	2	15.870	9031580158700	9031600158700
3/4	3/4	5	2 1/4	2	19.050	9031580190500	9031600190500



# UNI-PRO Ball Nose (2-Flute) - Metric - XL Long Length



## center cutting



Tool material

**Solid Carbide**

Surface finish

bright

FIREX®

Series

**3014**

**3030**

Application group	Material examples	Ideal for
<b>P</b>	Steel	●
<b>M</b>	Stainless steel	●
<b>K</b>	Cast iron	●
<b>N</b>	Aluminum	●
<b>S</b>	Ni / Ti alloys	○
<b>H</b>	Hardened steel	--

●=Optimal ○=Secondary

Speed and Feed data found on page 310

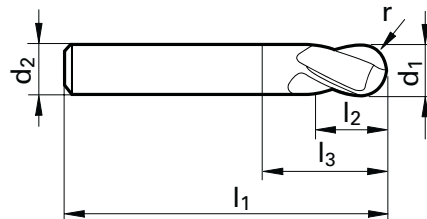

d1 h10	d2 h6	l1	l2	l3	No. of Flutes	Code no.	EDP Number	
mm	mm	mm	mm	mm				
3.000	3.000	75.00	20.00	47.00	2	3.000	9030140030000	9030300030000
4.000	4.000	75.00	25.00	47.00	2	4.000	9030140040000	9030300040000
5.000	5.000	75.00	30.00	47.00	2	5.000	9030140050000	9030300050000
6.000	6.000	75.00	30.00	39.00	2	6.000	9030140060000	9030300060000
8.000	8.000	100.00	40.00	64.00	2	8.000	9030140080000	9030300080000
10.000	10.000	100.00	40.00	60.00	2	10.000	9030140100000	9030300100000
12.000	12.000	150.00	45.00	105.00	2	12.000	9030140120000	9030300120000

# UNI-PRO Ball Nose (4-Flute) - Inch - Standard Length



## center cutting

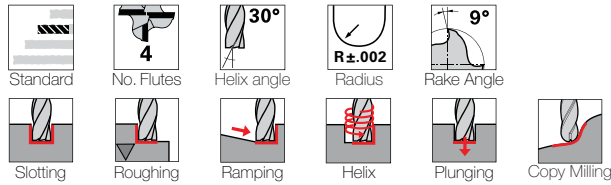

Tool material

Solid Carbide

Surface finish

bright

FIREX®

Series

3161

3165

Application group	Material examples	Ideal for
P	Steel	●
M	Stainless steel	●
K	Cast iron	●
N	Aluminum	●
S	Ni / Ti alloys	○
H	Hardened steel	--

●=Optimal ○=Secondary

Speed and Feed data found on page 297

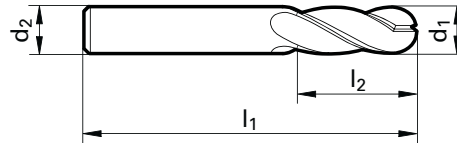

d1 h10	d2 h6	l1	l2	No. of Flutes	Code no.	EDP Number	
inch	inch	inch	inch				
1/16	1/8	1 1/2	3/16	4	1.590	9031610015900	9031650015900
5/64	1/8	1 1/2	9/32	4	1.980	9031610019800	9031650019800
3/32	1/8	1 1/2	1/4	4	2.380	9031610023800	9031650023800
7/64	1/8	1 1/2	3/8	4	2.780	9031610027800	9031650027800
1/8	1/8	1 1/2	3/8	4	3.170	9031610031700	9031650031700
9/64	3/16	2	1/2	4	3.570	9031610035700	9031650035700
5/32	3/16	2	1/2	4	3.970	9031610039700	9031650039700
11/64	3/16	2	5/8	4	4.370	9031610043700	9031650043700
3/16	3/16	2	5/8	4	4.760	9031610047600	9031650047600
13/64	1/4	2 1/2	5/8	4	5.160	9031610051600	9031650051600
7/32	1/4	2 1/2	5/8	4	5.560	9031610055600	9031650055600
15/64	1/4	2 1/2	3/4	4	5.950	9031610059500	9031650059500
1/4	1/4	2 1/2	3/4	4	6.350	9031610063500	9031650063500
17/64	5/16	2 1/2	3/4	4	6.750	9031610067500	9031650067500
9/32	5/16	2 1/2	3/4	4	7.140	9031610071400	9031650071400
19/64	5/16	2 1/2	13/16	4	7.540	9031610075400	9031650075400
5/16	5/16	2 1/2	13/16	4	7.940	9031610079400	9031650079400
21/64	3/8	2 1/2	1	4	8.330	9031610083300	9031650083300
11/32	3/8	2 1/2	1	4	8.730	9031610087300	9031650087300
23/64	3/8	2 1/2	1	4	9.130	9031610091300	9031650091300
3/8	3/8	2 1/2	1	4	9.520	9031610095200	9031650095200
25/64	7/16	2 3/4	1	4	9.920	9031610099200	9031650099200
13/32	7/16	2 3/4	1	4	10.320	9031610103200	9031650103200
27/64	7/16	2 3/4	1	4	10.720	9031610107200	9031650107200
7/16	7/16	2 3/4	1	4	11.110	9031610111100	9031650111100
29/64	1/2	3	1	4	11.510	9031610115100	9031650115100
15/32	1/2	3	1	4	11.910	9031610119100	9031650119100
31/64	1/2	3	1	4	12.300	9031610123000	9031650123000
1/2	1/2	3	1	4	12.700	9031610127000	9031650127000
9/16	9/16	3 1/2	1 1/8	4	14.290	9031610142900	9031650142900
5/8	5/8	3 1/2	1 1/4	4	15.870	9031610158700	9031650158700
3/4	3/4	4	1 1/2	4	19.050	9031610190500	9031650190500
1	1	4	1 1/2	4	25.400	9031610254000	9031650254000

# UNI-PRO Ball Nose (4-Flute) - Metric - Standard Length



## center cutting

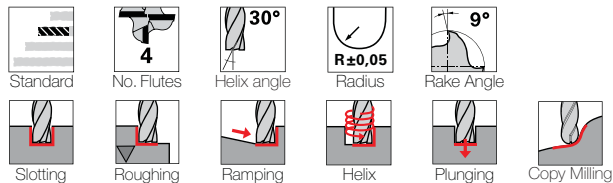

Tool material

Solid Carbide

Surface finish

bright

FIREX®

Series

3306

3727

Application group	Material examples	Ideal for
P	Steel	●
M	Stainless steel	●
K	Cast iron	●
N	Aluminum	●
S	Ni / Ti alloys	○
H	Hardened steel	--

●=Optimal ○=Secondary

Speed and Feed data found on page 310

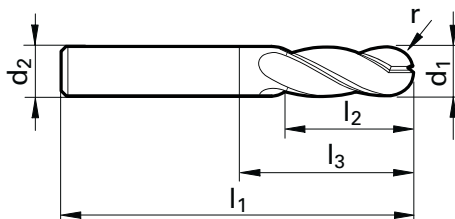

d1 h10	d2 h6	l1	l2	l3	No. of Flutes	Code no.	EDP Number	
mm	mm	mm	mm	mm				
4.000	4.000	50.00	11.00	22.00	4	4.000	9033060040000	9037270040000
5.000	5.000	50.00	13.00	22.00	4	5.000	9033060050000	9037270050000
6.000	6.000	57.00	13.00	21.00	4	6.000	9033060060000	9037270060000
8.000	8.000	63.00	19.00	27.00	4	8.000	9033060080000	9037270080000
10.000	10.000	72.00	22.00	32.00	4	10.000	9033060100000	9037270100000
12.000	12.000	83.00	26.00	38.00	4	12.000	9033060120000	9037270120000
14.000	14.000	83.00	26.00	38.00	4	14.000	9033060140000	9037270140000
16.000	16.000	92.00	32.00	44.00	4	16.000	9033060160000	9037270160000
18.000	18.000	92.00	32.00	44.00	4	18.000	9033060180000	9037270180000
20.000	20.000	104.00	38.00	54.00	4	20.000	9033060200000	9037270200000

# UNI-PRO Ball Nose (4-Flute) - Inch - Long Length



## center cutting



Long



No. Flutes



Helix angle



Radius



Rake Angle



Roughing



Ramping



Helix



Copy Milling



HA



HA

Tool material

Solid Carbide

Surface finish

bright

FIREX®

Series

3164

3167

Application group	Material examples	Ideal for
P	Steel	●
M	Stainless steel	●
K	Cast iron	●
N	Aluminum	●
S	Ni / Ti alloys	○
H	Hardened steel	--

●=Optimal    ○=Secondary

Speed and Feed data found on page 297

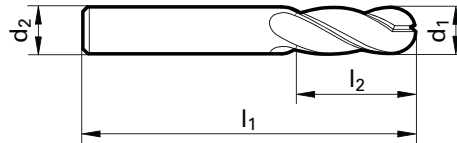

d1 h10	d2 h6	l1	l2	No. of Flutes	Code no.	EDP Number	
inch	inch	inch	inch				
1/8	1/8	2	1/2	4	3.170	9031640031700	9031670031700
3/16	3/16	2 1/2	3/4	4	4.760	9031640047600	9031670047600
1/4	1/4	3	1 1/8	4	6.350	9031640063500	9031670063500
5/16	5/16	3	1 1/8	4	7.940	9031640079400	9031670079400
3/8	3/8	3	1 1/8	4	9.520	9031640095200	9031670095200
7/16	7/16	4 1/2	2	4	11.110	9031640111100	9031670111100
1/2	1/2	4 1/2	2	4	12.700	9031640127000	9031670127000
5/8	5/8	5	2 1/4	4	15.870	9031640158700	9031670158700
3/4	3/4	5	2 1/4	4	19.050	9031640190500	9031670190500

# UNI-PRO Ball Nose (4-Flute) - Inch - XL Long Length



## center cutting

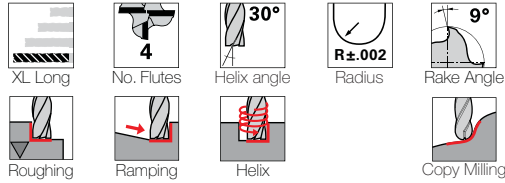

Tool material

**Solid Carbide**

Surface finish

bright

FIREX®

Series

**3162**

**3166**

Application group	Material examples	Ideal for
<b>P</b>	Steel	●
<b>M</b>	Stainless steel	●
<b>K</b>	Cast iron	●
<b>N</b>	Aluminum	●
<b>S</b>	Ni / Ti alloys	○
<b>H</b>	Hardened steel	--

●=Optimal    ○=Secondary

Speed and Feed data found on page 297

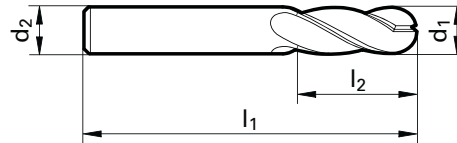

d1 h10	d2 h6	l1	l2	No. of Flutes	Code no.	EDP Number	
inch	inch	inch	inch				
3/16	3/16	3	1 1/4	4	4.760	9031620047600	9031660047600
1/4	1/4	4	1 5/8	4	6.350	9031620063500	9031660063500
5/16	5/16	4	1 5/8	4	7.940	9031620079400	9031660079400
3/8	3/8	4	1 5/8	4	9.520	9031620095200	9031660095200
7/16	7/16	5	2	4	11.110	9031620111100	9031660111100
1/2	1/2	6	3	4	12.700	9031620127000	9031660127000
5/8	5/8	6	3	4	15.870	9031620158700	9031660158700
3/4	3/4	6	3	4	19.050	9031620190500	9031660190500

# UNI-PRO Ball Nose (4-Flute) - Metric - XL Long Length



## center cutting



Tool material

Solid Carbide

Surface finish

bright

FIREX®

Series

3015

3043

Application group	Material examples	Ideal for
P	Steel	●
M	Stainless steel	●
K	Cast iron	●
N	Aluminum	●
S	Ni / Ti alloys	○
H	Hardened steel	--

●=Optimal    ○=Secondary

Speed and Feed data found on page 310

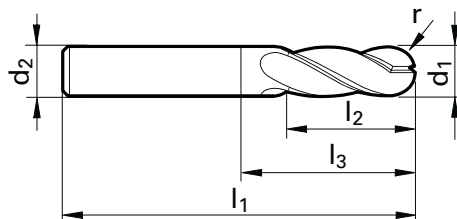

d1 h10	d2 h6	l1	l2	l3	No. of Flutes	Code no.	EDP Number	
mm	mm	mm	mm	mm				
3.000	3.000	75.00	20.00	47.00	4	3.000	9030150030000	9030430030000
4.000	4.000	75.00	25.00	47.00	4	4.000	9030150040000	9030430040000
5.000	5.000	75.00	30.00	47.00	4	5.000	9030150050000	9030430050000
6.000	6.000	75.00	30.00	39.00	4	6.000	9030150060000	9030430060000
8.000	8.000	100.00	40.00	64.00	4	8.000	9030150080000	9030430080000
10.000	10.000	100.00	40.00	60.00	4	10.000	9030150100000	9030430100000
12.000	12.000	150.00	45.00	105.00	4	12.000	9030150120000	9030430120000

# Chamfering milling cutters

with radial relief geometry  
for chamfering, de-burring  
and contour operations



## Summary of advantages

- radially relief ground
- universal application for all materials
- wear-resistant TiAlN-coating

## 60° Chamfering Milling Cutters - Metric



Tool material

**Solid Carbide**

Surface finish

TiAlN

Series

**6711**

**6712**

Application group	Material examples	Ideal for
P	Steel	●
M	Stainless steel	●
K	Cast iron	●
N	Aluminum	●
S	Ni / Ti alloys	○
H	Hardened steel	○

●=Optimal    ○=Secondary

Speed and Feed data found on page 263



d1	d2 h6	l1	l2	No. of Flutes	Code no.	EDP Number	EDP Number
mm	mm	mm	mm				
4.000	4.000	50.00	3.50	4	4.000	9067110040000	
6.000	6.000	57.00	5.20	4	6.000	9067110060000	9067120060000
8.000	8.000	63.00	7.00	4	8.000	9067110080000	9067120080000
10.000	10.000	72.00	8.70	4	10.000	9067110100000	9067120100000
12.000	12.000	83.00	10.40	4	12.000	9067110120000	9067120120000

# 90° Chamfering Milling Cutters - Metric



Tool material

**Solid Carbide**

Surface finish

TiAlN

Series

**6713**

**3396**

Application group	Material examples	Ideal for
<b>P</b>	Steel	●
<b>M</b>	Stainless steel	●
<b>K</b>	Cast iron	●
<b>N</b>	Aluminum	●
<b>S</b>	Ni / Ti alloys	○
<b>H</b>	Hardened steel	○

●=Optimal ○=Secondary

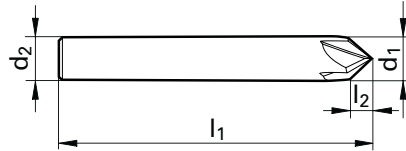

Speed and Feed data shown below

d1	d2 h6	l1	l2	No. of Flutes	Code no.	EDP Number	EDP Number
mm	mm	mm	mm				
4.000	4.000	50.00	2.00	4	4.000	<b>9067130040000</b>	
6.000	6.000	57.00	2.00	4	6.000	<b>9067130060000</b>	<b>9033960060000</b>
8.000	8.000	63.00	4.00	4	8.000	<b>9067130080000</b>	<b>9033960080000</b>
10.000	10.000	72.00	5.00	4	10.000	<b>9067130100000</b>	<b>9033960100000</b>
12.000	12.000	83.00	6.00	4	12.000	<b>9067130120000</b>	<b>9033960120000</b>

## Speeds & Feeds - Chamfering milling cutters

ISO	Hardness	SFM	Feed Rate IPT per Ø in (mm)							SFM	Feed Rate IPT per Ø in (mm)						
			3	6	8	10	12	16	20		3	6	8	10	12	16	20
<b>P</b>	Up to 25 HRc	<b>630</b>	0.0007	0.0014	0.0019	0.0024	0.0031	0.0039	0.0051	<b>820</b>	0.0010	0.0023	0.0031	0.0040	0.0051	0.0067	0.0083
	Over 25 HRc	<b>460</b>	0.0006	0.0012	0.0016	0.0024	0.0028	0.0035	0.0047		<b>590</b>	0.0010	0.0020	0.0028	0.0039	0.0047	0.0063
<b>M</b>	Up to 20 HRc	<b>390</b>	0.0005	0.0010	0.0013	0.0018	0.0020	0.0028	0.0035	<b>525</b>	0.0008	0.0017	0.0022	0.0031	0.0035	0.0047	0.0059
	20-30 HRc	<b>260</b>	0.0004	0.0007	0.0010	0.0014	0.0016	0.0024	0.0028		<b>325</b>	0.0006	0.0013	0.0017	0.0024	0.0028	0.0039
<b>K</b>	< 240 HB	<b>560</b>	0.0006	0.0012	0.0016	0.0024	0.0028	0.0035	0.0047	<b>755</b>	0.0010	0.0020	0.0028	0.0039	0.0047	0.0063	0.0079
<b>N</b>	< 7% Si	<b>820</b>	0.0009	0.0019	0.0024	0.0031	0.0039	0.0051	0.0067	<b>1080</b>	0.0015	0.0031	0.0041	0.0055	0.0067	0.0087	0.0110
<b>S</b>	Ti alloys ≤ 42 HRc	<b>260</b>	0.0003	0.0007	0.0009	0.0012	0.0016	0.0020	0.0023	<b>325</b>	0.0005	0.0011	0.0014	0.0018	0.0024	0.0030	0.0035
	Hi Temp ≤ 42 HRc	<b>130</b>	0.0004	0.0006	0.0008	0.0009	0.0013	0.0016	0.0019		<b>190</b>	0.0006	0.0009	0.0012	0.0014	0.0020	0.0024
<b>H</b>	Up to 55 HRc	<b>160</b>	0.0005	0.0010	0.0013	0.0020	0.0020	0.0027	0.0035	<b>230</b>	0.0008	0.0016	0.0022	0.0031	0.0035	0.0047	0.0059
	55 - 63 HRc	<b>130</b>	0.0004	0.0008	0.0010	0.0015	0.0016	0.0023	0.0027		<b>200</b>	0.0007	0.0013	0.0017	0.0023	0.0027	0.0039



# 90° Chamfering Milling Cutters - Metric



Tool material

**Solid Carbide**

Surface finish

nano-Si

Series

**6784**

**6785**

Application group	Material examples	Ideal for
<b>P</b>	Steel	●
<b>M</b>	Stainless steel	●
<b>K</b>	Cast iron	●
<b>N</b>	Aluminum	○
<b>S</b>	Ni / Ti alloys	○
<b>H</b>	Hardened steel	○

●=Optimal    ○=Secondary

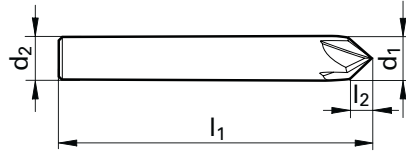

Speed and Feed data shown below

d1	d2 h6	l1	l2	No. of Flutes	Code no.	EDP Number	EDP Number
mm	mm	mm	mm				
4.000	4.000	50.00	2.00	4	4.000	<b>9067840040000</b>	
6.000	6.000	57.00	2.00	4	6.000	<b>9067840060000</b>	<b>9067850060000</b>
8.000	8.000	63.00	4.00	4	8.000	<b>9067840080000</b>	<b>9067850080000</b>
10.000	10.000	72.00	5.00	4	10.000	<b>9067840100000</b>	<b>9067850100000</b>
12.000	12.000	83.00	6.00	4	12.000	<b>9067840120000</b>	<b>9067850120000</b>

## Speeds & Feeds - Chamfering milling cutters

ISO	Hardness	SFM	Feed Rate IPT per Ø in (mm)							SFM	Feed Rate IPT per Ø in (mm)						
			3	6	8	10	12	16	20		3	6	8	10	12	16	20
<b>P</b>	Up to 25 HRc	<b>630</b>	0.0007	0.0014	0.0019	0.0024	0.0031	0.0039	0.0051	<b>820</b>	0.0010	0.0023	0.0031	0.0040	0.0051	0.0067	0.0083
	Over 25 HRc	<b>460</b>	0.0006	0.0012	0.0016	0.0024	0.0028	0.0035	0.0047		<b>590</b>	0.0010	0.0020	0.0028	0.0039	0.0047	0.0063
<b>M</b>	Up to 20 HRc	<b>390</b>	0.0005	0.0010	0.0013	0.0018	0.0020	0.0028	0.0035	<b>525</b>	0.0008	0.0017	0.0022	0.0031	0.0035	0.0047	0.0059
	20-30 HRc	<b>260</b>	0.0004	0.0007	0.0010	0.0014	0.0016	0.0024	0.0028		<b>325</b>	0.0006	0.0013	0.0017	0.0024	0.0028	0.0039
<b>K</b>	< 240 HB	<b>560</b>	0.0006	0.0012	0.0016	0.0024	0.0028	0.0035	0.0047	<b>755</b>	0.0010	0.0020	0.0028	0.0039	0.0047	0.0063	0.0079
<b>N</b>	< 7% Si	<b>820</b>	0.0009	0.0019	0.0024	0.0031	0.0039	0.0051	0.0067	<b>1080</b>	0.0015	0.0031	0.0041	0.0055	0.0067	0.0087	0.0110
<b>S</b>	Ti alloys ≤ 42 HRc	<b>260</b>	0.0003	0.0007	0.0009	0.0012	0.0016	0.0020	0.0023	<b>325</b>	0.0005	0.0011	0.0014	0.0018	0.0024	0.0030	0.0035
	Hi Temp ≤ 42 HRc	<b>130</b>	0.0004	0.0006	0.0008	0.0009	0.0013	0.0016	0.0019		<b>190</b>	0.0006	0.0009	0.0012	0.0014	0.0020	0.0024
<b>H</b>	Up to 55 HRc	<b>160</b>	0.0005	0.0010	0.0013	0.0020	0.0020	0.0027	0.0035	<b>230</b>	0.0008	0.0016	0.0022	0.0031	0.0035	0.0047	0.0059
	55 - 63 HRc	<b>130</b>	0.0004	0.0008	0.0010	0.0015	0.0016	0.0023	0.0027		<b>200</b>	0.0007	0.0013	0.0017	0.0023	0.0027	0.0039

# 120° Chamfering Milling Cutters - Metric



Tool material

**Solid Carbide**

Surface finish

TiAlN

Series

**6714**

**6715**

Application group	Material examples	Ideal for
<b>P</b>	Steel	●
<b>M</b>	Stainless steel	●
<b>K</b>	Cast iron	●
<b>N</b>	Aluminum	●
<b>S</b>	Ni / Ti alloys	○
<b>H</b>	Hardened steel	○

●=Optimal    ○=Secondary

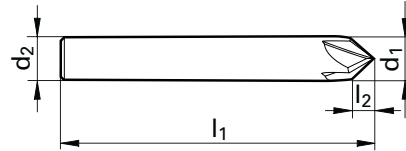

Speed and Feed data shown below

d1	d2 h6	l1	l2	No. of Flutes	Code no.	EDP Number	EDP Number
mm	mm	mm	mm				
4.000	4.000	50.00	1.20	4	4.000	<b>9067140040000</b>	
6.000	6.000	57.00	1.80	4	6.000	<b>9067140060000</b>	<b>9067150060000</b>
8.000	8.000	63.00	2.40	4	8.000	<b>9067140080000</b>	<b>9067150080000</b>
10.000	10.000	72.00	2.90	4	10.000	<b>9067140100000</b>	<b>9067150100000</b>
12.000	12.000	83.00	3.50	4	12.000	<b>9067140120000</b>	<b>9067150120000</b>

## Speeds & Feeds - Chamfering milling cutters

ISO	Hardness	SFM	Feed Rate IPT per Ø in (mm)							SFM	Feed Rate IPT per Ø in (mm)						
			3	6	8	10	12	16	20		3	6	8	10	12	16	20
<b>P</b>	Up to 25 HRc	<b>630</b>	0.0007	0.0014	0.0019	0.0024	0.0031	0.0039	0.0051	<b>820</b>	0.0010	0.0023	0.0031	0.0040	0.0051	0.0067	0.0083
	Over 25 HRc	<b>460</b>	0.0006	0.0012	0.0016	0.0024	0.0028	0.0035	0.0047		<b>590</b>	0.0010	0.0020	0.0028	0.0039	0.0047	0.0063
<b>M</b>	Up to 20 HRc	<b>390</b>	0.0005	0.0010	0.0013	0.0018	0.0020	0.0028	0.0035	<b>525</b>	0.0008	0.0017	0.0022	0.0031	0.0035	0.0047	0.0059
	20-30 HRc	<b>260</b>	0.0004	0.0007	0.0010	0.0014	0.0016	0.0024	0.0028		<b>325</b>	0.0006	0.0013	0.0017	0.0024	0.0028	0.0039
<b>K</b>	< 240 HB	<b>560</b>	0.0006	0.0012	0.0016	0.0024	0.0028	0.0035	0.0047	<b>755</b>	0.0010	0.0020	0.0028	0.0039	0.0047	0.0063	0.0079
<b>N</b>	< 7% Si	<b>820</b>	0.0009	0.0019	0.0024	0.0031	0.0039	0.0051	0.0067	<b>1080</b>	0.0015	0.0031	0.0041	0.0055	0.0067	0.0087	0.0110
<b>S</b>	Ti alloys ≤ 42 HRc	<b>260</b>	0.0003	0.0007	0.0009	0.0012	0.0016	0.0020	0.0023	<b>325</b>	0.0005	0.0011	0.0014	0.0018	0.0024	0.0030	0.0035
	Hi Temp ≤ 42 HRc	<b>130</b>	0.0004	0.0006	0.0008	0.0009	0.0013	0.0016	0.0019		<b>190</b>	0.0006	0.0009	0.0012	0.0014	0.0020	0.0024
<b>H</b>	Up to 55 HRc	<b>160</b>	0.0005	0.0010	0.0013	0.0020	0.0020	0.0027	0.0035	<b>230</b>	0.0008	0.0016	0.0022	0.0031	0.0035	0.0047	0.0059
	55 - 63 HRc	<b>130</b>	0.0004	0.0008	0.0010	0.0015	0.0016	0.0023	0.0027		<b>200</b>	0.0007	0.0013	0.0017	0.0023	0.0027	0.0039

# 6-Flute 90° Chamfering Milling Cutters - Metric

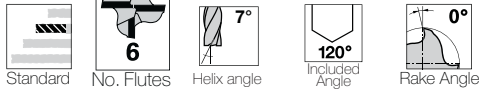

Tool material **Solid Carbide**

Surface finish **TiAlN**

Series **6786** **6787**

Application group	Material examples	Ideal for
<b>P</b>	Steel	●
<b>M</b>	Stainless steel	●
<b>K</b>	Cast iron	●
<b>N</b>	Aluminum	●
<b>S</b>	Ni / Ti alloys	○
<b>H</b>	Hardened steel	○

●=Optimal ○=Secondary

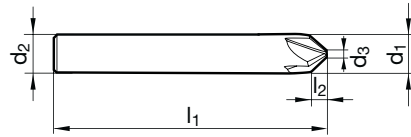

Speed and Feed data shown below

d1	d2 h6	d3	l1	l2	No. of Flutes	Code no.	EDP Number	
mm	mm	mm	mm	mm				
6.000	6.000	1.500	57.00	2.25	6	6.000	9067860060000	9067870060000
8.000	8.000	2.000	63.00	3.00	6	8.000	9067860080000	9067870080000
10.000	10.000	3.000	72.00	3.50	6	10.000	9067860100000	9067870100000
12.000	12.000	3.000	83.00	4.50	6	12.000	9067860120000	9067870120000
16.000	16.000	4.000	92.00	6.00	6	16.000	9067860160000	9067870160000
20.000	20.000	6.000	92.00	7.00	6	20.000	9067860200000	9067870200000

## Speeds & Feeds - Chamfering milling cutters

ISO	Hardness	SFM	Feed Rate IPT per Ø in (mm)							SFM	Feed Rate IPT per Ø in (mm)						
			3	6	8	10	12	16	20		3	6	8	10	12	16	20
<b>P</b>	Up to 25 HRc	<b>630</b>	0.0007	0.0014	0.0019	0.0024	0.0031	0.0039	0.0051	<b>820</b>	0.0010	0.0023	0.0031	0.0040	0.0051	0.0067	0.0083
	Over 25 HRc	<b>460</b>	0.0006	0.0012	0.0016	0.0024	0.0028	0.0035	0.0047		<b>590</b>	0.0010	0.0020	0.0028	0.0039	0.0047	0.0063
<b>M</b>	Up to 20 HRc	<b>390</b>	0.0005	0.0010	0.0013	0.0018	0.0020	0.0028	0.0035	<b>525</b>	0.0008	0.0017	0.0022	0.0031	0.0035	0.0047	0.0059
	20-30 HRc	<b>260</b>	0.0004	0.0007	0.0010	0.0014	0.0016	0.0024	0.0028		<b>325</b>	0.0006	0.0013	0.0017	0.0024	0.0028	0.0039
<b>K</b>	< 240 HB	<b>560</b>	0.0006	0.0012	0.0016	0.0024	0.0028	0.0035	0.0047	<b>755</b>	0.0010	0.0020	0.0028	0.0039	0.0047	0.0063	0.0079
<b>N</b>	< 7% Si	<b>820</b>	0.0009	0.0019	0.0024	0.0031	0.0039	0.0051	0.0067	<b>1080</b>	0.0015	0.0031	0.0041	0.0055	0.0067	0.0087	0.0110
<b>S</b>	Ti alloys ≤ 42 HRc	<b>260</b>	0.0003	0.0007	0.0009	0.0012	0.0016	0.0020	0.0023	<b>325</b>	0.0005	0.0011	0.0014	0.0018	0.0024	0.0030	0.0035
	Hi Temp ≤ 42 HRc	<b>130</b>	0.0004	0.0006	0.0008	0.0009	0.0013	0.0016	0.0019		<b>190</b>	0.0006	0.0009	0.0012	0.0014	0.0020	0.0024
<b>H</b>	Up to 55 HRc	<b>160</b>	0.0005	0.0010	0.0013	0.0020	0.0020	0.0027	0.0035	<b>230</b>	0.0008	0.0016	0.0022	0.0031	0.0035	0.0047	0.0059
	55 - 63 HRc	<b>130</b>	0.0004	0.0008	0.0010	0.0015	0.0016	0.0023	0.0027		<b>200</b>	0.0007	0.0013	0.0017	0.0023	0.0027	0.0039

# Corner Rounding Milling Cutters



Standard



No. Flutes



Helix angle



Rake Angle



Tool material

**Solid Carbide**

Surface finish

FIREX

Series

**6788**

Application group	Material examples	Ideal for
<b>P</b>	Steel	●
<b>M</b>	Stainless steel	●
<b>K</b>	Cast iron	●
<b>N</b>	Aluminum	●
<b>S</b>	Ni / Ti alloys	○
<b>H</b>	Hardened steel	○

●=Optimal ○=Secondary

Speed and Feed data shown below



d1	r	d2	d3	l1	No. of Flutes	Code no.	EDP Number
mm	mm	mm	mm	mm			
6.000	0.50	6.000	5.000	50.00	4	6.005	<b>9067880060050</b>
6.000	1.00	6.000	4.000	50.00	4	6.010	<b>9067880060100</b>
8.000	1.50	8.000	5.000	58.00	4	8.015	<b>9067880080150</b>
10.000	2.00	10.000	6.000	66.00	4	10.020	<b>9067880100200</b>
10.000	2.50	10.000	5.000	66.00	4	10.025	<b>9067880100250</b>
12.000	3.00	12.000	6.000	73.00	4	12.030	<b>9067880120300</b>
14.000	3.50	14.000	7.000	75.00	4	14.035	<b>9067880140350</b>
14.000	4.00	14.000	6.000	75.00	4	14.040	<b>9067880140400</b>
16.000	4.50	16.000	7.000	76.00	4	16.045	<b>9067880160450</b>
16.000	5.00	16.000	6.000	76.00	4	16.050	<b>9067880160500</b>
20.000	5.50	20.000	9.000	92.00	4	20.055	<b>9067880200550</b>
20.000	6.00	20.000	8.000	92.00	4	20.060	<b>9067880200600</b>

## Speeds & Feeds - Radius milling cutters

ISO	Hardness	SFM	Feed Rate IPT per Ø in (mm)						
			3	6	8	10	12	16	20
			<b>Chamfering</b>			ap/ae max = 0.25 x D			
<b>P</b>	Up to 25 HRc	<b>460</b>	0.0006	0.0011	0.0014	0.0019	0.0023	0.0031	0.0039
	Over 25 HRc	<b>360</b>	0.0005	0.0009	0.0013	0.0018	0.0020	0.0028	0.0035
<b>M</b>	Up to 20 HRc	<b>330</b>	0.0004	0.0007	0.0010	0.0014	0.0016	0.0024	0.0028
	20-30 HRc	<b>230</b>	0.0003	0.0006	0.0008	0.0011	0.0012	0.0020	0.0024
<b>K</b>	< 240 HB	<b>425</b>	0.0005	0.0010	0.0013	0.0018	0.0020	0.0028	0.0035
<b>N</b>	< 7% Si	<b>620</b>	0.0007	0.0014	0.0019	0.0025	0.0031	0.0039	0.0051
<b>S</b>	Ti alloys ≤ 42 HRc	<b>230</b>	0.0003	0.0006	0.0008	0.0011	0.0012	0.0020	0.0024
	Hi Temp ≤ 42 HRc	<b>115</b>	0.0003	0.0006	0.0008	0.0010	0.0011	0.0018	0.0020
<b>H</b>	Up to 55 HRc	<b>130</b>	0.0004	0.0005	0.0010	0.0012	0.0013	0.0020	0.0025
	55 - 63 HRc	<b>115</b>	0.0003	0.0006	0.0008	0.0010	0.0011	0.0018	0.0020

# Front/back deburrer - Metric



Standard



No. Flutes



Helix angle



Included Angle



Rake Angle



Tool material

**Solid Carbide**

Surface finish

nano-A™

Series

**495**

Application group	Material examples	Ideal for
<b>P</b>	Steel	●
<b>M</b>	Stainless steel	●
<b>K</b>	Cast iron	●
<b>N</b>	Aluminum	●
<b>S</b>	Ni / Ti alloys	○
<b>H</b>	Hardened steel	○

●=Optimal ○=Secondary

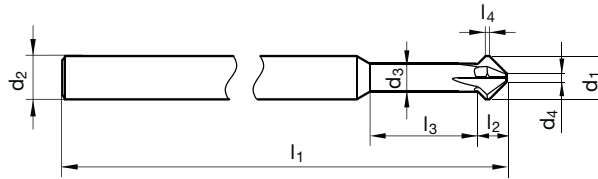

Speed and Feed data shown below

This tool is capable of chamfering on both front and backside of tool.

d1	d2 h6	d3	d4	l1	l4	l3	l2	No. of Flutes	Code no.	EDP Number
mm	mm	mm	mm	mm	mm	mm	mm			
3.000	4.000	2.200	0.600	75.00	0.50	9.30	2.10	4	3.000	<b>9004950030000</b>
4.000	4.000	2.900	0.800	75.00	0.50	12.30	2.70	4	4.000	<b>9004950040000</b>
5.000	5.000	3.900	1.000	75.00	0.50	15.00	3.00	4	5.000	<b>9004950050000</b>
6.000	6.000	3.900	1.200	100.00	0.50	14.30	3.50	4	6.000	<b>9004950060000</b>
8.000	6.000	6.000	1.600	100.00	0.50		4.70	4	8.000	<b>9004950080000</b>
10.000	6.000	6.000	2.000	100.00	0.50		6.50	4	10.000	<b>9004950100000</b>
12.000	6.000	6.000	2.400	100.00	0.50		8.30	4	12.000	<b>9004950120000</b>

## Speeds & Feeds - Chamfering milling cutters

ISO	Hardness	SFM	Feed Rate IPT per Ø in (mm)						
			3	6	8	10	12	16	20
<b>P</b>	≤ 850 N/mm <sup>2</sup>	<b>590</b>	0.0031	0.0047	0.0079	0.0079	0.0098	0.0098	0.0098
	≥ 850 N/mm <sup>2</sup>	<b>490</b>	0.0024	0.0039	0.0059	0.0059	0.0079	0.0079	0.0079
<b>M</b>	≤ 750 N/mm <sup>2</sup>	<b>330</b>	0.0024	0.0039	0.0059	0.0059	0.0079	0.0079	0.0079
	≥ 750 N/mm <sup>2</sup>	<b>260</b>	0.0020	0.0031	0.0047	0.0047	0.0059	0.0059	0.0059
<b>K</b>	≤ 350 HB	<b>395</b>	0.0031	0.0047	0.0079	0.0079	0.0098	0.0098	0.0098
<b>N</b>	≤ 3% Si	<b>655</b>	0.0039	0.0059	0.0098	0.0098	0.0118	0.0118	0.0118
	> 3% Si	<b>490</b>	0.0031	0.0047	0.0079	0.0079	0.0098	0.0098	0.0098
<b>S</b>	≤ 850 N/mm <sup>2</sup>	<b>195</b>	0.0020	0.0031	0.0047	0.0047	0.0059	0.0059	0.0059
	≤ 1400 N/mm <sup>2</sup>	<b>130</b>	0.0016	0.0024	0.0039	0.0039	0.0047	0.0047	0.0047
<b>H</b>	< 55 HRC	<b>330</b>	0.0024	0.0039	0.0059	0.0059	0.0079	0.0079	0.0079
	≤ 63 HRC	<b>130</b>	0.0016	0.0020	0.0024	0.0024	0.0031	0.0031	0.0031

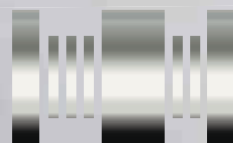

# GROOVING SYSTEMS

BY **GUHRING**

Highest quality and flexibility  
thanks to a vast product offering.  
All from one supplier.

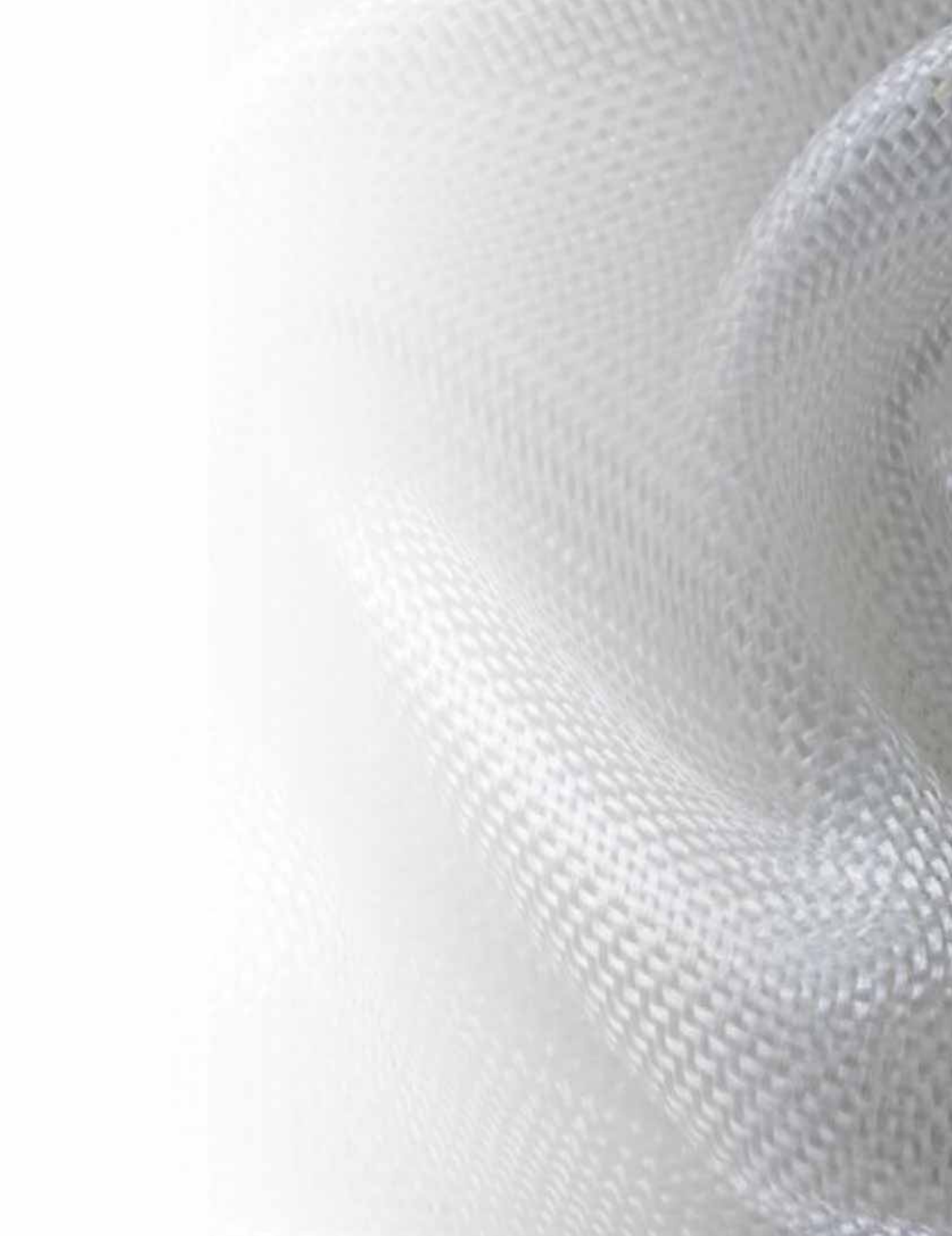



# **TECHNICAL**



# Milling cutter types and their primary fields of application

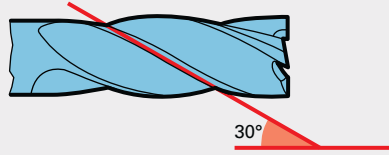

**Type N**

Quick spiral with 30° helical pitch, suitable for finish milling structural, case hardened and heat-treatable steels as well as short-chipping non-ferrous metals and materials up to

- 1200 N/mm<sup>2</sup> tensile strength applying high speed steel milling cutters
- 1600 N/mm<sup>2</sup> tensile strength applying solid carbide milling cutters

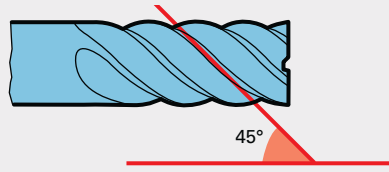

**Type NH**

Quick spiral with high 45° helical pitch, suitable for super fine finishing high-alloyed materials and grey cast iron up to appr.

- 1600 N/mm<sup>2</sup> tensile strength

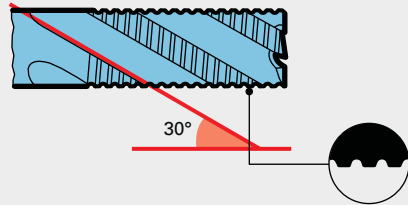

**Type NF**

Flat knuckle-type teeth/quick spiral, produces short chips and improved smoother surface quality in comparison to type NR or NRf. Suitable for milling standard materials up to appr.

- 1200 N/mm<sup>2</sup> tensile strength applying high speed steel milling cutters
- 1600 N/mm<sup>2</sup> tensile strength applying solid carbide milling cutters

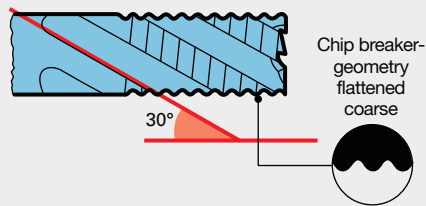

**Type NR**

Standard knuckle-type teeth, produces short chips and good chip evacuation. Suitable for milling standard materials up to appr.

- 1000 N/mm<sup>2</sup> tensile strength applying high speed steel milling cutters
- 1200 N/mm<sup>2</sup> tensile strength applying solid carbide milling cutters

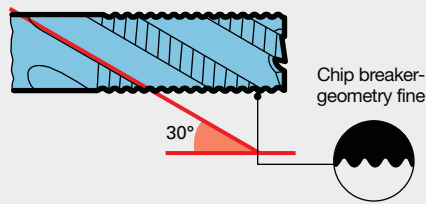

**Type NRf**

Fine knuckle-type teeth, produces short chips and good chip evacuation. Better feed rates possible than with type NR. Suitable for milling materials with a high tensile strength up to appr.

- 1400 N/mm<sup>2</sup> tensile strength applying high speed steel milling cutters
- 1600 N/mm<sup>2</sup> tensile strength applying solid carbide milling cutters

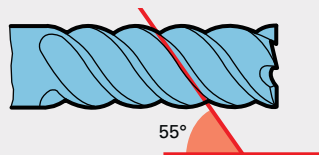

**Type H**

Quick spiral with high 55° helical pitch, suitable for super-fine finishing as well as HSC\* machining of all hardened materials and chilled cast iron up to appr.

- 62 HRC hardness

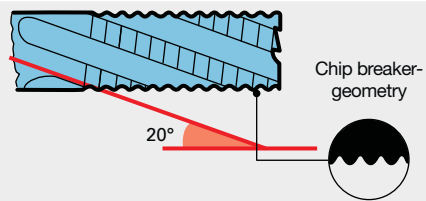

**Type HR**

Fine knuckle-type teeth, produces short chips with good chip evacuation. Suitable for milling hardened materials as well as grey and chilled cast iron with up to appr.

- 56 HRC hardness

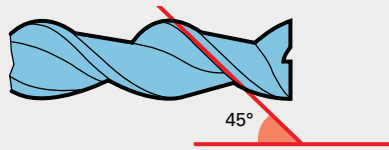

**Type W**

Quick spiral with 45° helical pitch, suitable for finish milling soft materials such as aluminum, Al-alloys and non-ferrous metals up to appr.

- 600 N/mm<sup>2</sup> tensile strength

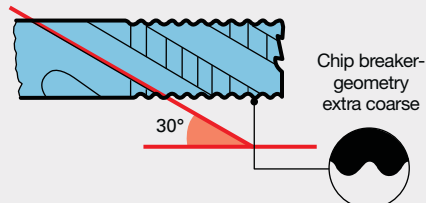

**Type WR**

Coarse knuckle-type teeth, produces short chips with good chip evacuation. Suitable for milling aluminum, non-ferrous metals as well as soft steels up to appr.

- 600 N/mm<sup>2</sup> tensile strength.

# Milling cutter types and their primary fields of application

	<p><b>RF 100 U (type N)</b> 35°/38° helix. Suitable for slotting, roughing and finishing steel, high-alloyed steel and hardened steel up to</p> <ul style="list-style-type: none"> <li>• 1600 N/mm<sup>2</sup> tensile strength (48 HRC)</li> </ul>
	<p><b>RF 100U (type NH) 3-fluted</b> 41°/43°/45° helix. Suitable for slotting, roughing and finishing steel, high-alloyed steel and stainless steel up to</p> <ul style="list-style-type: none"> <li>• 1400 N/mm<sup>2</sup> tensile strength (44 HRC)</li> </ul> <p>3-fluted suitable for extreme cutting depths</p>
	<p><b>RF 100 U/HF (type HF)</b> 30°/32° helix and roughing and finishing geometry. Suitable for slotting and roughing with large cutting widths and depths in steel, high-alloyed steel and hardened steel up to</p> <ul style="list-style-type: none"> <li>• 1600 N/mm<sup>2</sup> tensile strength (48 HRC)</li> </ul>
	<p><b>RF 100 F (type NH)</b> 40°/42° helix. Suitable for slotting, roughing and finishing as well as HPC-milling/imachining tough steels as well as other long-chipping materials up to</p> <ul style="list-style-type: none"> <li>• 850 N/mm<sup>2</sup> tensile strength (25 HRC)</li> </ul>
	<p><b>RF 100 VA (type N)</b> 36°/38° helix. Suitable for slotting, roughing and finishing VA steels and stainless materials</p>
	<p><b>RF 100 VA/NF (type NF)</b> 36°/38° helix and roughing and finishing geometry. Suitable for slotting and roughing VA steels and stainless materials</p>
	<p><b>RF 100 A (type W)</b> 39°/40°/41° helix. Suitable for slotting, roughing and finishing aluminum and Al-alloys as well as long-chipping materials and non-ferrous metals</p>
	<p><b>RF 100 A/WF (type WF)</b> 29°/30°/31° helix and roughing and finishing geometry. Suitable for slotting and roughing aluminum and Al-alloys</p>
	<p><b>RF 100 H (type H)</b> 40°/42° helix and progressive core diameter. Suitable for roughing up to 1xD in materials up to 54 HRC, for finishing over the entire cutting edge length in materials over 63 HRC. With HPC strategy suitable for roughing materials &gt; 63 HRC.</p>
	<p><b>RF 100 Ti (type N)</b> 35°/38° helix with corner radius. Suitable for slotting and roughing of titanium alloys as well as difficult-to-cut alloys</p>
	<p><b>RF 100 SF (type NH)</b> 44°/45°/46° helix. Suitable for HSC super fine finishing for semi-roughing with feed widths up to max. 0.3xD and HPC roughing over the entire cutting edge length for standard steels, cast iron, non-ferrous metals and high-alloyed materials</p>

Milling Formulas - INCH Values

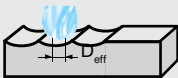
Symbol	Description		Formula
SFM	Surface Feet / Minute		$SFM = \frac{RPM \times D}{3.82}$
RPM	Revolutions / Minute		$RPM = \frac{SFM \times 3.82}{D}$
IPT	Feed / Tooth		$IPT = \frac{IPM}{z \times RPM}$
IPM	Inches / Minute		$IPM = IPT \times RPM \times z$
D <sub>(eff)</sub>	Effective Diameter		$D(eff) = 2 \times \sqrt{R^2 - (R - D_1)^2}$

Symbol key: D = tool diameter (in.) z = no. of flutes R = radius D<sub>1</sub> = DOC (ap)

Milling Formulas - METRIC Values

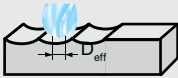
Symbol	Description		Formula
Vc	Surface Meters / Minute		$Vc = \frac{\pi \times D \times n}{1000}$
n	Revolutions / Minute		$n = \frac{Vc \times 1000}{\pi \times D}$
fz	Feed / Tooth		$fz = \frac{vf}{n \times z}$
vf	Millimeters / Minute		$vf = (n) \times (z) \times (fz)$
D(eff)	Effective Diameter		$D(eff) = 2 \times \sqrt{D \times ap - ap^2}$

Symbol key: π = 3.1416 D = tool diameter (mm) z = no. of flutes ap = depth of cut

# Comparison of Hardness

Tens. strength (N/mm <sup>2</sup> )	HRC	HB30	HV10	Tens. strength (N/mm <sup>2</sup> )	HRC	HB30	HV10
240		71	75	940	29	278	293
255		76	80	970	30	287	302
270		81	85	995	31	295	310
285		86	90	1020	32	301	317
305		90	95	1050	33	311	327
320		95	100	1080	34	319	336
335		100	105	1110	35	328	345
350		105	110	1140	36	337	355
370		109	115	1170	37	346	364
385		114	120	1200	38	354	373
400		119	125	1230	39	363	382
415		124	130	1260	40	372	392
430		128	135	1300	41	383	403
450		133	140	1330	42	393	413
465		138	145	1360	43	402	423
480		143	150	1400	44	413	434
495		147	155	1440	45	424	446
510		152	160	1480	46	435	458
530		157	165	1530	47	449	473
545		162	170	1570	48	460	484
560		166	175	1620	49	472	497
575		171	180	1680	50	488	514
595		176	185	1730	51	501	527
610		181	190	1790	52	517	544
625		185	195	1845	53	532	560
640		190	200	1910	54	549	578
660		195	205	1980	55	567	596
675		199	210	2050	56	584	615
690		204	215	2140	57	607	639
705		209	220	2180	58	622	655
720		214	225		59		675
740		219	230		60		698
755		223	235		61		720
770		228	240		62		745
785		233	245		63		773
800	22	238	250		64		800
820	23	242	255		65		829
835	24	247	260		66		864
860	25	255	268		67		900
870	26	258	272		68		940
900	27	266	280				
920	28	273	287				

## Tolerances to DIN ISO 286

Nominal diameter range in µm/tolerances in µm

		from 1 up to 3	over 3 up to 6	over 6 up to 10	over 10 up to 18	over 18 up to 30	over 30 up to 50	over 50 up to 80	over 80 up to 120	over 120 up to 180	over 180 up to 250
Tolerances: Position and Grade Shafts	h 6	0	0	0	0	0	0	0	0	0	0
		-6	-8	-9	-11	-13	-16	-19	-22	-25	-29
	h 7	0	0	0	0	0	0	0	0	0	0
		-10	-12	-15	-18	-21	-25	-30	-35	-40	-46
	h 8	0	0	0	0	0	0	0	0	0	0
		-14	-18	-22	-27	-33	-39	-46	-54	-63	-72
	h 9	0	0	0	0	0	0	0	0	0	0
		-25	-30	-36	-43	-52	-62	-74	-87	-100	-115
	h 10	0	0	0	0	0	0	0	0	0	0
		-40	-48	-58	-70	-84	-100	-120	-140	-160	-185
	e 8*	-14	-20	-25	-32	-40	-50	-60	-72	-85	-100
		-28	-38	-47	-59	-73	-89	-106	-126	-148	-172

\*Milling cutters to tolerance e8 produce key slots to tolerance P9 with one cut.

## General notes

All the cutting rate recommendations specified in this catalog are standard values valid exclusively for new tools or tools re-ground to Guhring specifications. Pre-requisites are stable machines, optimal cooling, optimal tool clamping and

maximum concentricity of the tool and the machine spindle. Our recommended cutting rates must be reduced if the conditions deviate. The values may also be adjusted to influence Surface finish quality, machining rate or tool life.

### 1. Workpiece clamping

Loss of tool life or tool breakage through unstable clamping

- improve workpiece clamping

#### Alternative:

- reduce feed
- reduce cutting width or depth

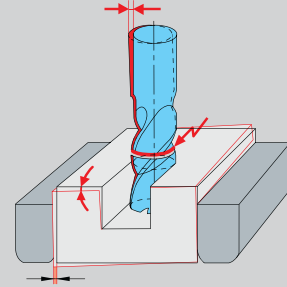

### 2. Tool clamping

Loss of tool life or tool breakage through unstable, worn or too small/long/thin tool holder

- apply new or larger tool holder or holder with increased clamping force and increased concentricity

#### Alternative:

- reduce cutting rates
- reduce clamping length
- apply tool with smaller diameter
- check clamping screws for wear

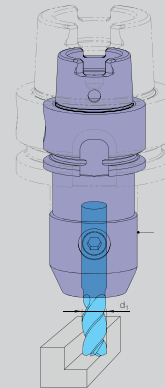

### 3. Surface finish quality

Excessive peak-to-valley height Ra/Rz at the tool Surface finish through excessive feed rates or vibrations

- improve workpiece clamping and tool clamping (see points 1 and 2)

#### Alternative:

- reduce feed and feed rate
- increase cutting speed

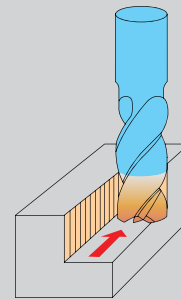

### 4. Vibrations

High tool wear, insufficient workpiece Surface finish quality and insufficient dimensional accuracy through vibration

- improve workpiece and tool clamping (see points 1 and 2)
- increase tooth feed, because the chip centre thickness is too small
- modify speed
- modify milling strategy, i.e. select alternative cutting distribution
- change tool selection, i.e. reduce no. of teeth or spiral

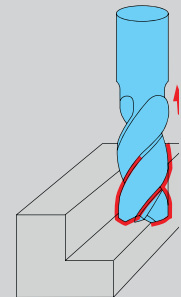

## 5. Chip congestion/cooling

Significant reduction in tool life, chipping on cutting edges, edge build-up of flutes through insufficient chip evacuation

- select milling cutters with internal cooling

### Alternative:

- peripheral cooling via GM 300 chuck
- increase volume flow
- adjust coolant flow
- apply compressed air cooling (according to tool and material)
- reduce feed rate
- modify cutting distribution
- select end mill with fewer flutes

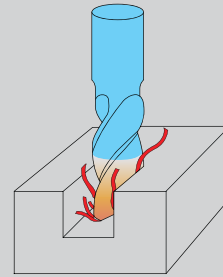

## 6. Pecking when drilling

Significant reduction in tool life as well as chipping of cutting edges through insufficient chip evacuation and thermal stresses

- select milling cutter with internal cooling
- ☑ with drilling depths  $> 0.5 \times D$  pecking in stages

### Alternative:

- peripheral cooling via GM 300 chuck
- increase volume flow
- adjust coolant flow
- reduce feed rate

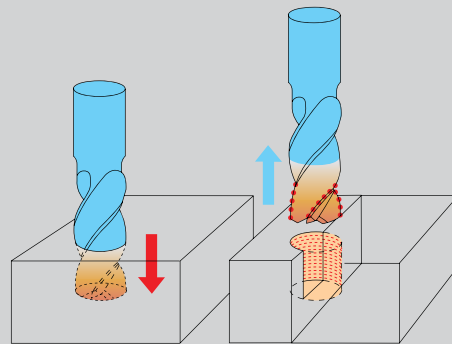

## 7. Thermal influence on materials

Through welding or torch cutting, the material characteristics at the parting line do not correspond with the specified material class

- reduce cutting rates
- select tool for materials with a higher tensile strength

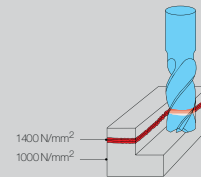

44 HRC

32 HRC

## 8. Entry in hardened materials

For entering materials over 44 HRC, reduce the feed rate IPT in accordance with the illustration on the right

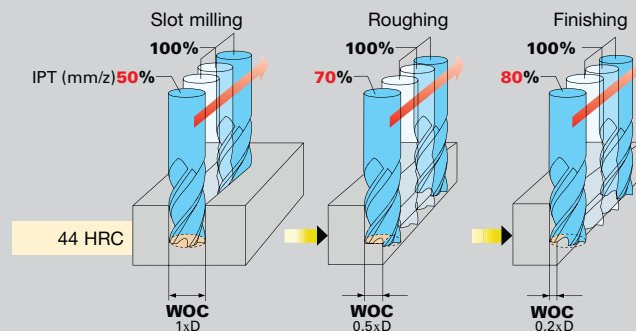

## 9. Loss in tool life with interrupted cutting

Significant loss in tool life through interrupted cutting (especially with milling angles of  $90^\circ$ )

- modify cutting distribution
- reduce feed rate for entry and exit
- reduce approach angle

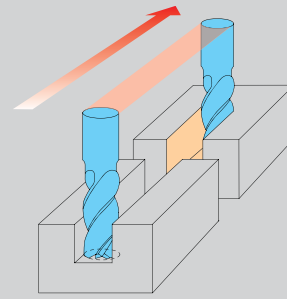

## 10. Feed rate adjustment: Modifying the cutting depth

- when modifying the cutting depth DOC, the feed rate must be reduced in accordance with the illustration on the right
- cutting speed or revolutions remain unchanged up to cutting depths of  $3 \times D$ , must only be adapted over  $3 \times D$

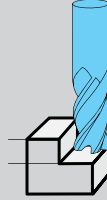

DOC = 1 x D  
IPT = 100 %



DOC = 2 x D  
IPT = 50 %

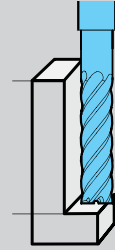

DOC = 3 x D  
IPT = 25 %

## 11. Copy milling

For cutting depths  $DOC < 0.5 \times D$ , the engaged effective diameter  $D_{eff}$  must be applied to calculate the speed. With the spindle not engaged, the effective diameter is calculated according to the illustration below. To increase tool life, we recommend machining with tilted spindle. The tilt angle must be taken into account when calculating the effective diameter  $D_{eff}$ .

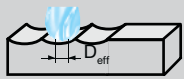

$$D_{(eff)} = 2 \cdot \sqrt{D \cdot DOC - DOC^2}$$

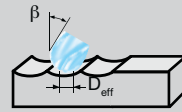

$$D_{(eff)} = D \cdot \sin \left[ \beta + \arccos \left( \frac{D - 2DOC}{D} \right) \right]$$

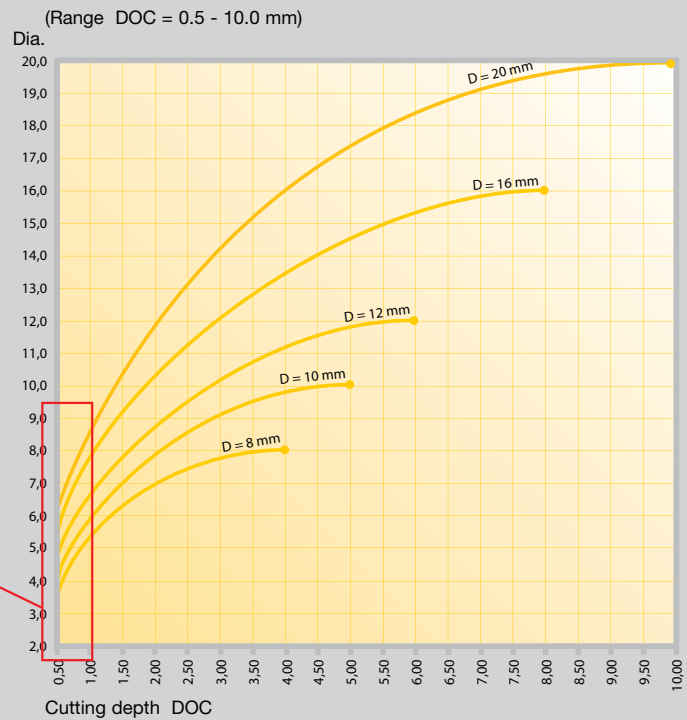
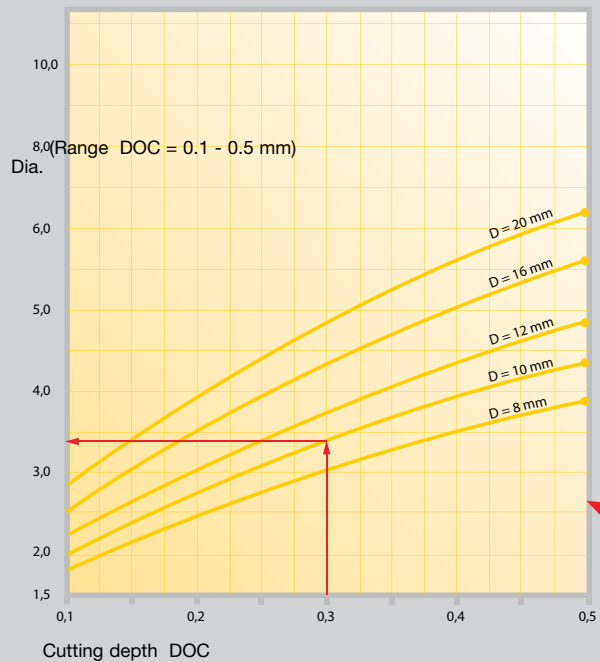

Modifying the cutting width WOC results in improved Surface finish quality of the workpiece (reduced peak-to-valley height)

$$R_{th} = \frac{D}{2} - \sqrt{\frac{D^2 - WOC^2}{4}}$$

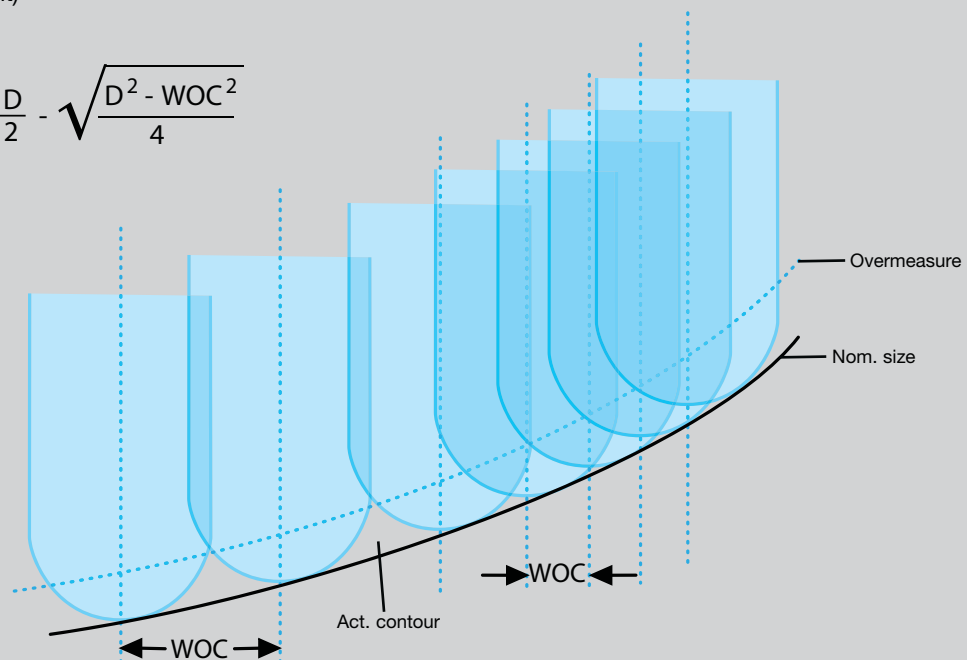



## 12. Plunging Strategies

### Entry methods for standard face geometry cutters

#### Simple Ramp



Ramp angle =  $2^\circ - 5^\circ$  with max depth  $1 \times D$

fz 75%

#### Pendulum



Ramp angle =  $1^\circ - 4^\circ$  with max depth  $1 \times D$

fz 75%

#### Helical



Feed =  $0.05 - 0.15 \times D$  per revolution  
Diameter of interpolation should be at least =  $1.7 \times D$

fz 100%

#### Plunge milling



Max radial engagement =  $0.25 \times D$   
Alternative for problems caused by excessive radial forces

fz 100%

#### Drilling/Piloting



Pecking cycles required for drilling depths over  $.5 \times D$

fz 50%

Base fz = fz slotting

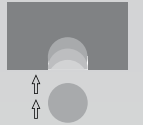
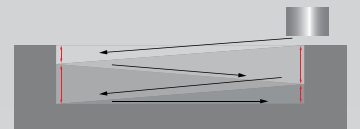
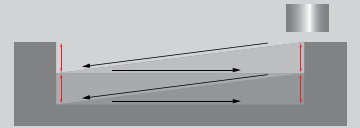

### Entry methods for tools with special Diver face geometry cutters

#### RF 100 Diver - pages 36 - 46

- $36^\circ - 37^\circ - 38^\circ$  Helix angle
- Good drilling capabilities
- Very good milling capabilities



First choice: milling, ramping, and plunging



#### Simple Ramp



Ramp angle =  $15^\circ - 45^\circ$  with max depth  $1 \times D$

#### Pendulum



Ramp angle =  $10^\circ - 20^\circ$  with max depth  $1 \times D$

#### Helical



Feed =  $0.10 - 0.30 \times D$  per revolution  
Diameter of interpolation should be at least =  $1.7 \times D$

#### Plunge milling



Max radial engagement =  $0.25 \times D$   
Alternative for problems caused by excessive radial forces







#### Drilling/Piloting



Pecking cycles required for drilling depths over  $1 \times D$

## 13. Tool Cooling

### General Recommendations

<b>Steel</b>			
<b>Cast</b>		Machine Dry, Air Blast:	<ul style="list-style-type: none"><li>• Avoid Thermal Shock</li><li>• Heat is transferred to the chip</li><li>• Air blast to assist in chip evacuation</li></ul>
<b>Hard</b>			
<b>Stainless</b>		Emulsion, Oil:	<ul style="list-style-type: none"><li>• Provide cooling to the cutting edge</li><li>• Prevention of built up edge</li><li>• Aid in chip evacuation</li></ul>
<b>Ti/HTA</b>			
<b>Non-Ferrous</b>		Emulsion, MMS:	<ul style="list-style-type: none"><li>• Prevention of built up edge</li><li>• Aid in chip evacuation</li></ul>

### Exceptions for material groups



#### As a general Rule

If it is not possible to avoid the use of coolant, the cutting speed and radial engagement should be reduced compared with dry machining. This will result in lower cutting temperatures and the risk of thermal shock will be decreased.

#### Chip evacuation

Coolant should be used in applications where chip evacuation is not possible. Recutting chips will lead to accelerated tool wear and breakage

### Additional considerations for coolant use

#### Finishing

- Better surface finish can be achieved in finishing through the use of coolant

#### Long Length Tools

- Coolant can provide a vibration dampening effect in long reach applications by reducing friction

#### Optimal coolant application

- Make sure that the coolant is directed as close as possible to the cutting edge
- Do not flush chips back into the cutting area

#### Internal Cooling

- Internal cooling provides the best chip removal with very good cooling to the cutting edge

#### Peripheral cooling / Gührojet

- This is a very good option for external cooling as the coolant is transmitted through the tool, directly to the cutting edge



**GÜHROJET**

## 14. HPC and HSC Milling Strategies

High Performance and High Speed Cutting strategies are some of the most effective application methods for today's solid carbide milling tools. By utilizing chip thinning strategies, significant increases in productivity and tool life can be achieved. These methods are also helpful when using machines with less power and stability. Even with weaker machines and less stable working conditions, very high cutting parameters can be achieved. These strategies are particularly effective for increasing process reliability in difficult to machine materials and long length to diameter ratios.

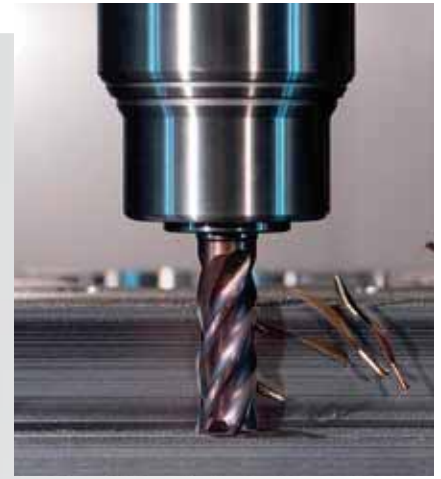

### HIGH PERFORMANCE CUTTING

High material removal rates → Stable conditions; short reach; medium radial engagement; low temperatures at the cutting edge



### HIGH SPEED CUTTING

High speeds and high feed rates → Long reach; low radial engagement; high process reliability; Low power consumption



# HPC AND HSC - MILLING STRATEGIES

## Requirement to the Periphery

Can be used in any material group



- Increased productivity when used in easy to machine material
- Increased process reliability when used in difficult to machine material

Advantages in lighter duty machines

- Short acceleration paths
- High spindle speeds
- Small to medium tool diameters

Advantages in Heavy Duty Machines

- Stable Feed axis
- High spindle torque
- Medium to large tool diameters

Stability of workpiece clamping

- Stable = vibration free machining
- Unstable = reduction of radial forces
- Maximum cutting volume
- Increased process safety

## Application Parameters

Small cutting width up to 0.33 x D

- Low radial engagement <math><70^\circ</math>
- Cutting edge spends less time in contact with workpiece

Very high feed rate

- Reduced chip thickness results in a significantly higher feed rate

Very high cutting speed

- Reduced heating and prolonged cooling allow for very high speeds

High cutting depth

- Improved leverage
- High removal rates
- Increased contact points of the tool

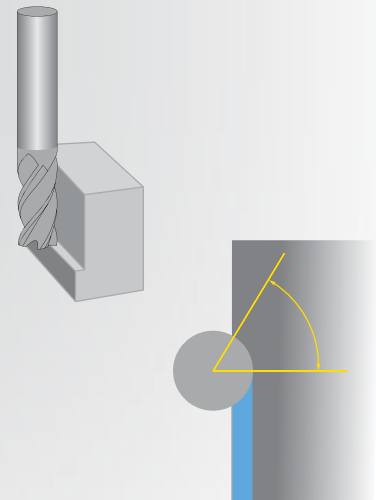

*Angle of engagement & Tool contact time*

## Removal Rate

The formula below calculates cubic Inches of material removed per minute. This calculation is important in determining the efficiency of your milling strategy.

$$DOC_{(ap)} \times WOC_{(ae)} \times \text{Feed rate}(\text{inch}/\text{min}) = \text{In}^3/\text{Min}$$

# HPC and HSC Milling Strategies

## Engagement angle

The engagement angle is important in determining the load acting on the tool. Engagement remains constant in straight milling paths, increases in concave paths, and decreases in convex paths.

- Straight Milling path
- Constant engagement angle
  - Constant tool load

Example:  $ae .20 \times D = 53^\circ$  engagement

Engagement remains constant

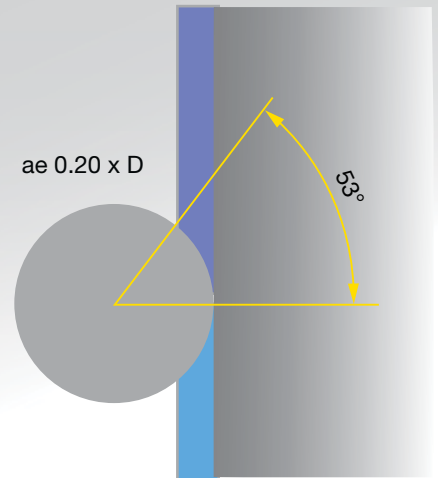

## Convex milling path

- Engagement decreases as tool enters radius
- Tool load decreases

Example:  $ae .20 \times D = 53^\circ$  engagement

Engagement is reduced to 45°

Result: Feed can be increased

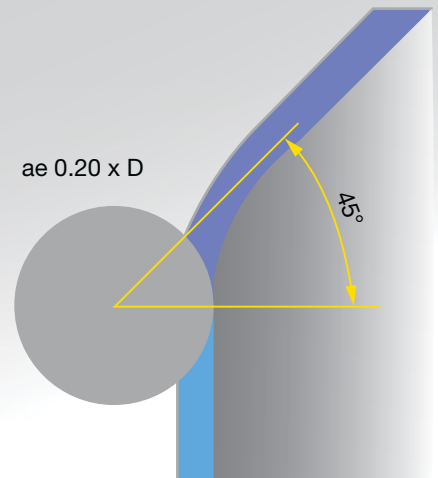

## Concave milling path

- Engagement decreases as tool enters radius
- Tool load increasing

Example:  $ae .20 \times D = 53^\circ$  engagement

Engagement is increased to 74°

Result: Feed must be reduced

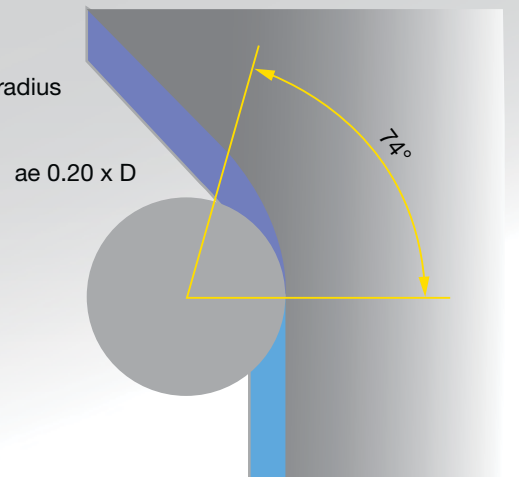

# HPC AND HSC - MILLING STRATEGIES

## Engagement angle at 90° corner radii

Tool radius = corner radius

- Abrupt increase in tool load
- Catastrophic failure of cutting tool likely

Example:  $ae .20 \times D = 53^\circ$  engagement

Engagement increases 270% from  $53^\circ$  to  $143^\circ$

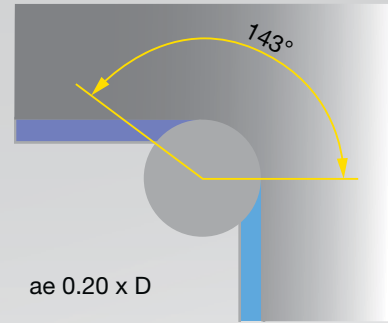

Tool radius smaller than corner radius

- Corner created by interpolating path
- No sudden increase in tool load
- Smaller increase in tool load

Example:  $ae .20 \times D = 53^\circ$  engagement

Engagement increases 174% from  $53^\circ$  to  $92^\circ$

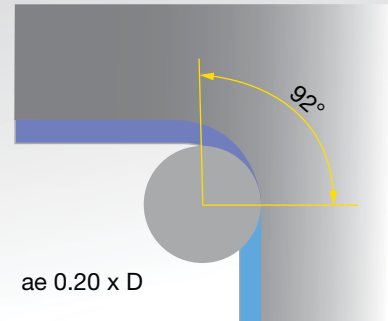

## Ratio of slot width to tool diameter during trochoidal milling

Groove Width  $1.7 - 2.0 \times D$

- C shaped tool path
- $ae \text{ max. } 0.10 \times D$  (theoretical  $37^\circ$ )
- Engagement angle increases by up to 50% ( $55^\circ$  engagement)

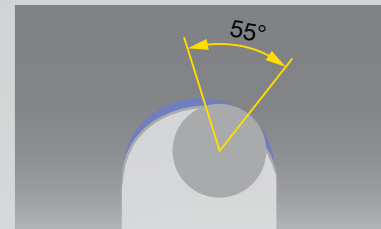

Groove Width  $2.1 - 3.0 \times D$

- C shaped tool path
- $ae \text{ max. } 0.15 \times D$  (theoretical  $46^\circ$ )
- Engagement angle increases by up to 30% ( $60^\circ$  engagement)

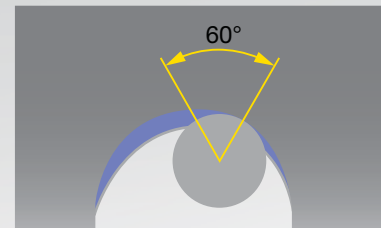

Groove Width  $3.1 \times D$

- D shaped tool path
- $ae \text{ max. } 0.20 \times D$  (theoretical  $53^\circ$ )
- Engagement angle increases by up to 40% ( $74^\circ$  engagement)

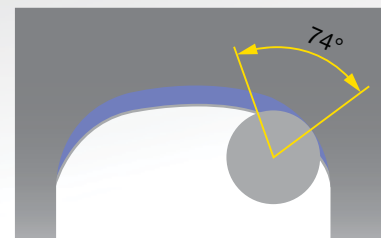

## SLOTING

Material	Hardness	Cutting depth. ( $a_p$ )	Cutting width ( $a_w$ )	SFM	Feed Rate Inch per Tooth - IPT d1 End Mill Diameter						
					1/8	1/4	5/16	3/8	1/2	5/8	3/4
Struct./free-cutting steels, unall. heat-treat./case hard. steels	up to 28 HRc	1 x D	1xd	890	.0005	.0010	.0013	.0019	.0025	.0031	.0038
Free-cutting steels, unalloyed case hard. steels, nitr. steels	28 - 38 HRc	1 x D	1xd	750	.0005	.0010	.0013	.0019	.0025	.0031	.0038
Alloyed heat-treatable, tool and high speed steels	28 - 44 HRc	1 x D	1xd	590	.0004	.0009	.0011	.0017	.0023	.0028	.0034
Stainless steel - easy to machine / sulphured	up to 20 HRc	1 x D	1xd	390	.0004	.0009	.0011	.0017	.0023	.0028	.0034
Stainless steel - moderately difficult to machine	20 - 30 HRc	1 x D	1xd	260	.0004	.0008	.0010	.0015	.0020	.0025	.0030
Titanium, Titanium alloys	up to 44 HRc	1 x D	1xd	200	.0004	.0008	.0010	.0015	.0020	.0025	.0030
Cast iron, grey cast iron, spher. graphite/malleable cast iron	over 240 HB 30	1 x D	1xd	490	.0005	.0010	.0013	.0019	.0025	.0031	.0038
Aluminum, Al-wrought alloys, Al-alloys	up to 7% Si	1 x D	1xd	1640	.0007	.0014	.0017	.0024	.0033	.0041	.0049
Aluminum-cast alloys	over 7% Si	1 x D	1xd	1120	.0006	.0011	.0014	.0021	.0028	.0034	.0041

## HIGH-VOLUME ROUGHING

Material	Hardness	Cutting depth. ( $a_p$ )	Cutting width ( $a_w$ )	SFM	Feed Rate Inch per Tooth - IPT d1 End Mill Diameter						
					1/8	1/4	5/16	3/8	1/2	5/8	3/4
Struct./free-cutting steels, unall. heat-treat./case hard. steels	up to 28 HRc	1.5 x D	0.40 x D	1150	.0007	.0013	.0016	.0024	.0031	.0039	.0047
Free-cutting steels, unalloyed case hard. steels, nitr. steels	28 - 38 HRc	1.5 x D	0.40 x D	950	.0007	.0013	.0016	.0024	.0031	.0039	.0047
Alloyed heat-treatable, tool and high speed steels	28 - 44 HRc	1.5 x D	0.33 x D	850	.0006	.0011	.0014	.0022	.0029	.0037	.0044
Stainless steel - easy to machine / sulphured	up to 20 HRc	1.5 x D	0.33 x D	525	.0006	.0011	.0014	.0022	.0029	.0037	.0044
Stainless steel - moderately difficult to machine	20 - 30 HRc	1.5 x D	0.25 x D	390	.0006	.0012	.0015	.0023	.0030	.0038	.0045
Titanium, Titanium alloys	up to 44 HRc	1.5 x D	0.33 x D	360	.0005	.0010	.0013	.0020	.0026	.0032	.0039
Cast iron, grey cast iron, spher. graphite/malleable cast iron	over 240 HB 30	1.5 x D	0.40 x D	620	.0007	.0013	.0016	.0024	.0031	.0039	.0047
Aluminum, Al-wrought alloys, Al-alloys	up to 7% Si	1.5 x D	0.40 x D	1976	.0009	.0017	.0021	.0030	.0041	.0051	.0061
Aluminum-cast alloys	over 7% Si	1.5 x D	0.40 x D	1440	.0007	.0014	.0018	.0026	.0035	.0043	.0052

## HIGH-SPEED FINISHING

Material	Hardness	Cutting depth. ( $a_p$ )	Cutting width ( $a_w$ )	SFM	Feed Rate Inch per Tooth - IPT d1 End Mill Diameter						
					1/8	1/4	5/16	3/8	1/2	5/8	3/4
Struct./free-cutting steels, unall. heat-treat./case hard. steels	up to 28 HRc	2 x D	0.02 x D	1776	.0006	.0012	.0014	.0021	.0028	.0034	.0041
Free-cutting steels, unalloyed case hard. steels, nitr. steels	28 - 38 HRc	2 x D	0.02 x D	1500	.0006	.0012	.0014	.0021	.0028	.0034	.0041
Alloyed heat-treatable, tool and high speed steels	28 - 44 HRc	2 x D	0.02 x D	1150	.0005	.0010	.0012	.0019	.0025	.0031	.0037
Stainless steel - easy to machine / sulphured	up to 20 HRc	2 x D	0.02 x D	720	.0005	.0010	.0012	.0019	.0025	.0031	.0037
Stainless steel - moderately difficult to machine	20 - 30 HRc	2 x D	0.02 x D	525	.0005	.0009	.0011	.0017	.0022	.0027	.0033
Titanium, Titanium alloys	up to 44 HRc	2 x D	0.02 x D	430	.0005	.0009	.0011	.0017	.0022	.0027	.0033
Cast iron, grey cast iron, spher. graphite/malleable cast iron	over 240 HB 30	2 x D	0.02 x D	980	.0006	.0012	.0014	.0021	.0028	.0034	.0041
Aluminum, Al-wrought alloys, Al-alloys	up to 7% Si	2 x D	0.02 x D	3280	.0008	.0015	.0019	.0027	.0036	.0045	.0054
Aluminum-cast alloys	over 7% Si	2 x D	0.02 x D	2230	.0006	.0013	.0016	.0023	.0030	.0038	.0045



## RAMPING - HELICAL INTERPOLATION

Material	Hardness	Ramping depth* (DOC max.)	Ramping* max. angle in °	SFM	Feed Rate Inch per Tooth - IPT d1 End Mill Diameter						
					1/8	1/4	5/16	3/8	1/2	5/8	3/4
Struct./free-cutting steels, unall. heat-treat./case hard. steels	up to 28 HRc	1 x D	45°	890	.0005	.0010	.0012	.0017	.0023	.0028	.0034
Free-cutting steels, unalloyed case hard. steels, nitr. steels	28 - 38 HRc	1 x D	45°	762	.0004	.0008	.0010	.0015	.0020	.0025	.0030
Alloyed heat-treatable, tool and high speed steels	28 - 44 HRc	1 x D	30°	590	.0003	.0007	.0009	.0011	.0015	.0019	.0023
Stainless steel - easy to machine / sulphured	up to 20 HRc	1 x D	10°	390	.0003	.0006	.0007	.0011	.0015	.0019	.0023
Stainless steel - moderately difficult to machine	20 - 30 HRc	0.5 x D	5°	260	.0002	.0005	.0005	.0009	.0013	.0016	.0019
Titanium, Titanium alloys	up to 44 HRc	0.5 x D	10°	200	.0002	.0005	.0005	.0009	.0013	.0016	.0019
Cast iron, grey cast iron, spher. graphite/malleable cast iron	over 240 HB 30	1 x D	45°	490	.0005	.0010	.0012	.0017	.0023	.0028	.0034
Aluminum, Al-wrought alloys, Al-alloys	up to 7% Si	1 x D	30°	1640	.0004	.0008	.0010	.0015	.0020	.0025	.0030
Aluminum-cast alloys	over 7% Si	1 x D	45°	1120	.0005	.0010	.0012	.0017	.0023	.0028	.0034

## DRILLING

Material	Hardness	Drilling depth** (a <sub>p</sub> max.)	SFM	Feed Rate Inch per Tooth - IPT d1 End Mill Diameter						
				1/8	1/4	5/16	3/8	1/2	5/8	3/4
Struct./free-cutting steels, unall. heat-treat./case hard. steels	up to 28 HRc	2 x D	890	.0005	.0009	.0011	.0015	.0020	.0025	.0030
Free-cutting steels, unalloyed case hard. steels, nitr. steels	28 - 38 HRc	2 x D	790	.0004	.0008	.0009	.0013	.0018	.0022	.0026
Alloyed heat-treatable, tool and high speed steels	28 - 44 HRc	1 x D	660	.0003	.0005	.0006	.0009	.0013	.0016	.0019
Cast iron, grey cast iron, spher. graphite/malleable cast iron	over 240 HB 30	2 x D	490	.0005	.0009	.0011	.0015	.0020	.0025	.0030
Aluminum, Al-wrought alloys, Al-alloys	up to 7% Si	1 x D	590	.0004	.0008	.0009	.0013	.0018	.0022	.0026
Aluminum-cast alloys	over 7% Si	1 x D	460	.0005	.0009	.0011	.0015	.0020	.0025	.0030

**HPC** HPC = High Performance Cutting

Maximum volume

**HSC** HSC = High Speed Cutting

Maximum speed





## SLOTING

Material	Hardness	max. ap	max. ae	Max. Angle of Engagement	SFM	feed rate inch per tooth							
						1/8	3/16	1/4	5/16	3/8	1/2	5/8	3/4
Struct./free-cutting steels, unall. heat-treat./case hard. steels	up to 28 HRc	0.80 x D	1.00 x D	180°	525	0.0006	0.0008	0.0011	0.0017	0.0021	0.0028	0.0034	0.0041
Alloyed heat-treatable, tool and high speed steels	28 - 44 HRc	0.80 x D	1.00 x D	180°	410	0.0006	0.0008	0.0011	0.0016	0.0019	0.0025	0.0031	0.0038
Stainless steel - easy to machine / sulphured	up to 20 HRc	0.80 x D	1.00 x D	180°	275	0.0004	0.0007	0.0009	0.0011	0.0013	0.0018	0.0022	0.0026
Stainless steel - moderately difficult to machine	20 - 30 HRc	0.80 x D	1.00 x D	180°	180	0.0004	0.0007	0.0009	0.0011	0.0013	0.0018	0.0022	0.0026
Titanium	up to 40 HRc	0.80 x D	1.00 x D	180°	150	0.0004	0.0007	0.0009	0.0011	0.0013	0.0018	0.0022	0.0026
High Temp Alloys Inconel, Nimonic, Hastelloy, Monel	up to 40 HRc	0.80 x D	1.00 x D	180°	100	0.0004	0.0006	0.0008	0.0009	0.0011	0.0015	0.0019	0.0023

## HIGH-VOLUME ROUGHING

Material	Hardness	max. ap	max. ae	Max. Angle of Engagement	SFM	feed rate inch per tooth							
						1/8	3/16	1/4	5/16	3/8	1/2	5/8	3/4
Struct./free-cutting steels, unall. heat-treat./case hard. steels	up to 28 HRc	max ap = flute length (l <sub>2</sub> )	0.20 x D	53°	875	0.0009	0.0014	0.0018	0.0028	0.0033	0.0044	0.0055	0.0066
Alloyed heat-treatable, tool and high speed steels	28 - 44 HRc		0.20 x D	53°	690	0.0009	0.0014	0.0018	0.0025	0.0030	0.0040	0.0050	0.0060
Stainless steel - easy to machine / sulphured	up to 20 HRc		0.15 x D	46°	500	0.0008	0.0012	0.0017	0.0021	0.0025	0.0033	0.0042	0.0050
Stainless steel - moderately difficult to machine	20 - 30 HRc		0.10 x D	37°	325	0.0010	0.0015	0.0020	0.0025	0.0030	0.0040	0.0050	0.0060
Titanium	up to 40 HRc		0.08 x D	31°	300	0.0011	0.0016	0.0022	0.0027	0.0033	0.0044	0.0055	0.0066
High Temp Alloys Inconel, Nimonic, Hastelloy, Monel	up to 40 HRc		0.08 x D	31°	200	0.0009	0.0014	0.0019	0.0023	0.0028	0.0038	0.0047	0.0056

## HIGH-SPEED ROUGHING

Material	Hardness	max. ap	max. ae	Max. Angle of Engagement	SFM	feed rate inch per tooth							
						1/8	3/16	1/4	5/16	3/8	1/2	5/8	3/4
Struct./free-cutting steels, unall. heat-treat./case hard. steels	up to 28 HRc	max ap = flute length (l <sub>2</sub> )	0.15 x D	46°	950	0.0011	0.0016	0.0021	0.0033	0.0039	0.0052	0.0065	0.0078
Alloyed heat-treatable, tool and high speed steels	28 - 44 HRc		0.15 x D	46°	750	0.0011	0.0016	0.0021	0.0030	0.0036	0.0048	0.0059	0.0071
Stainless steel - easy to machine / sulphured	up to 20 HRc		0.10 x D	37°	550	0.0010	0.0015	0.0020	0.0025	0.0030	0.0040	0.0050	0.0060
Stainless steel - moderately difficult to machine	20 - 30 HRc		0.08 x D	31°	360	0.0011	0.0016	0.0022	0.0027	0.0033	0.0044	0.0055	0.0066
Titanium	up to 40 HRc		0.05 x D	26°	325	0.0011	0.0016	0.0022	0.0027	0.0033	0.0044	0.0055	0.0066
High Temp Alloys Inconel, Nimonic, Hastelloy, Monel	up to 40 HRc		0.05 x D	26°	225	0.0009	0.0014	0.0019	0.0023	0.0028	0.0038	0.0047	0.0056

## HIGH-SPEED FINISHING

Material	Hardness	max. ap	max. ae	Max. Angle of Engagement	SFM	feed rate inch per tooth							
						1/8	3/16	1/4	5/16	3/8	1/2	5/8	3/4
Struct./free-cutting steels, unall. heat-treat./case hard. steels	up to 28 HRc	max ap = flute length (l <sub>2</sub> )	0.02 x D	18°	1050	0.0008	0.0012	0.0016	0.0024	0.0029	0.0039	0.0048	0.0058
Alloyed heat-treatable, tool and high speed steels	28 - 44 HRc		0.02 x D	18°	825	0.0008	0.0012	0.0016	0.0022	0.0026	0.0035	0.0044	0.0053
Stainless steel - easy to machine / sulphured	up to 20 HRc		0.02 x D	18°	560	0.0006	0.0009	0.0012	0.0015	0.0018	0.0025	0.0031	0.0037
Stainless steel - moderately difficult to machine	20 - 30 HRc		0.01 x D	11°	395	0.0008	0.0012	0.0016	0.0020	0.0024	0.0032	0.0039	0.0047
Titanium	up to 40 HRc		0.01 x D	11°	330	0.0008	0.0012	0.0016	0.0020	0.0024	0.0032	0.0039	0.0047
High Temp Alloys Inconel, Nimonic, Hastelloy, Monel	up to 40 HRc		0.01 x D	11°	230	0.0007	0.0010	0.0014	0.0017	0.0020	0.0027	0.0034	0.0041



## HIGH-VOLUME ROUGHING

Material	Hardness	max. ap	max. ae	Max. Angle of Engagement	SFM	feed rate inch per tooth							
						1/8	3/16	1/4	5/16	3/8	1/2	5/8	3/4
Struct./free-cutting steels, unall. heat-treat./case hard. steels	up to 28 HRc	max $a_p$ = flute length ( $l_2$ )	0.15 x D	46°	925	0.0011	0.0016	0.0021	0.0033	0.0039	0.0052	0.0065	0.0078
Alloyed heat-treatable, tool and high speed steels	28 - 44 HRc		0.15 x D	46°	725	0.0011	0.0016	0.0021	0.0030	0.0036	0.0048	0.0059	0.0071
Stainless steel - easy to machine / sulphured	up to 20 HRc		0.10 x D	37°	525	0.0010	0.0015	0.0020	0.0025	0.0030	0.0040	0.0050	0.0060
Stainless steel - moderately difficult to machine	20 - 30 HRc		0.10 x D	37°	330	0.0010	0.0015	0.0020	0.0025	0.0030	0.0040	0.0050	0.0060
Titanium	up to 40 HRc		0.08 x D	31°	300	0.0011	0.0016	0.0022	0.0027	0.0033	0.0044	0.0055	0.0066
High Temp Alloys Inconel, Nimonic, Hastelloy, Monel	up to 40 HRc		0.08 x D	31°	195	0.0009	0.0014	0.0019	0.0023	0.0028	0.0038	0.0047	0.0056

## HIGH-SPEED ROUGHING

Material	Hardness	max. ap	max. ae	Max. Angle of Engagement	SFM	feed rate inch per tooth							
						1/8	3/16	1/4	5/16	3/8	1/2	5/8	3/4
Struct./free-cutting steels, unall. heat-treat./case hard. steels	up to 28 HRc	max $a_p$ = flute length ( $l_2$ )	0.10 x D	37°	1015	0.0013	0.0019	0.0026	0.0040	0.0047	0.0063	0.0079	0.0095
Alloyed heat-treatable, tool and high speed steels	28 - 44 HRc		0.10 x D	37°	790	0.0013	0.0019	0.0026	0.0036	0.0043	0.0058	0.0072	0.0086
Stainless steel - easy to machine / sulphured	up to 20 HRc		0.08 x D	31°	560	0.0011	0.0016	0.0022	0.0027	0.0033	0.0044	0.0055	0.0066
Stainless steel - moderately difficult to machine	20 - 30 HRc		0.08 x D	31°	360	0.0011	0.0016	0.0022	0.0027	0.0033	0.0044	0.0055	0.0066
Titanium	up to 40 HRc		0.05 x D	26°	330	0.0011	0.0016	0.0022	0.0027	0.0033	0.0044	0.0055	0.0066
High Temp Alloys Inconel, Nimonic, Hastelloy, Monel	up to 40 HRc		0.05 x D	26°	230	0.0009	0.0014	0.0019	0.0023	0.0028	0.0038	0.0047	0.0056

## HIGH-SPEED FINISHING

Material	Hardness	max. ap	max. ae	Max. Angle of Engagement	SFM	feed rate inch per tooth							
						1/8	3/16	1/4	5/16	3/8	1/2	5/8	3/4
Struct./free-cutting steels, unall. heat-treat./case hard. steels	up to 28 HRc	max $a_p$ = flute length ( $l_2$ )	0.01 x D	11°	1120	0.0010	0.0015	0.0020	0.0031	0.0037	0.0050	0.0062	0.0074
Alloyed heat-treatable, tool and high speed steels	28 - 44 HRc		0.01 x D	11°	885	0.0010	0.0015	0.0020	0.0028	0.0034	0.0045	0.0056	0.0068
Stainless steel - easy to machine / sulphured	up to 20 HRc		0.01 x D	11°	590	0.0008	0.0012	0.0016	0.0020	0.0024	0.0032	0.0039	0.0047
Stainless steel - moderately difficult to machine	20 - 30 HRc		0.01 x D	11°	395	0.0008	0.0012	0.0016	0.0020	0.0024	0.0032	0.0039	0.0047
Titanium	up to 40 HRc		0.01 x D	11°	330	0.0008	0.0012	0.0016	0.0020	0.0024	0.0032	0.0039	0.0047
High Temp Alloys Inconel, Nimonic, Hastelloy, Monel	up to 40 HRc		0.01 x D	11°	230	0.0007	0.0010	0.0014	0.0017	0.0020	0.0027	0.0034	0.0041

# FEEDS & SPEEDS FOR RF100 U, F, VA, A, SF, Ti, H, RF 50

INCH

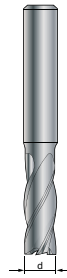

Surface feet per minute - SFM				
DOC (ap)		WOC (ae)		
High Speed Milling		Rough	Slot	
DOC 2xd		DOC 1xd		
WOC .05xd	WOC .1xd	WOC .25xd	WOC .4 to .9xd	WOC 1xd

For finishing use WOC (ae) .01 up to .1xd, use SFM from .25xd column, do not increase IPT from table values

$$RPM = \frac{SFM}{d_1} \times 3.82$$

$$IPM = \text{No. of teeth} \times IPT \times RPM$$

Feed Rate Inch per Tooth - IPT							
d1 End Mill Diameter							
1/8 3.17mm	1/4 6.35mm	5/16 7.94mm	3/8 9.52mm	1/2 12.70mm	5/8 15.87mm	3/4 19.05mm	1 25.40mm

Material	Hardness	TYPE	WOC				
			2.5	2.3	1.5	1	1

Multiply IPT x this factor based on WOC							
.0007	.0013	.0016	.0023	.0030	.0040	.0045	.0060
.0006	.0012	.0015	.0021	.0028	.0035	.0041	.0056
.0006	.0011	.0014	.0019	.0025	.0031	.0038	.0052
.0005	.0009	.0011	.0015	.0020	.0023	.0030	.0040
Finishing only WOC less than .1xd							
.0003	.0006	.0008	.0010	.0013	.0016	.0019	.0028
.0006	.0011	.0014	.0019	.0025	.0031	.0038	.0052
.0005	.0010	.0013	.0017	.0023	.0027	.0034	.0044
.0005	.0009	.0011	.0015	.0020	.0023	.0030	.0040
.0003	.0007	.0009	.0012	.0016	.0020	.0023	.0032
.0004	.0006	.0008	.0009	.0013	.0016	.0019	.0024
.0007	.0014	.0017	.0024	.0033	.0039	.0049	.0064
.0006	.0013	.0016	.0021	.0028	.0035	.0041	.0056
.0008	.0016	.0020	.0030	.0040	.0051	.0060	.0080
.0007	.0014	.0017	.0023	.0030	.0039	.0045	.0060
.0006	.0013	.0016	.0021	.0028	.0035	.0041	.0056
.0007	.0014	.0017	.0023	.0030	.0039	.0045	.0060

Structural + free-cutting steels, unalloyed heat-treatable + case hardened steels A283, 1151, 1215, L10, 10Lxx, 11Lxx, 12Lxx, 41Lxx, 51Lxx, 86Lxx, 86Lxx, 10xx	up to 28 HRc	F VA SF	1200	1100	900	650	575
Free-cutting steels, unalloyed case hardened steels, nitriding steels 1151, 1215, L10, 10Lxx, 11Lxx, 12Lxx, 41Lxx, 51Lxx, 86Lxx, 86Lxx, 10xx, 11xx	28 to 38 HRc	U F SF	1100	1000	850	650	525
Alloyed heat-treatable, tool and high speed steels 13xx, 2340, 31xx, 32xx, 33xx, 34xx, 40xx, 41xx, 43xx, 4640, 50xx, 51xx, 61xx, 71xx, 86xx, 87xx, 92xx, 98xx, 98xx, Ax, Ox, Dx, Hxx, Lx, Wx, Mx, Tx	28 to 44 HRc	U U SF	900	800	680	650	425
Hardened Steels Carbon and Alloy Steels, Tool & Die Steels	Up to 54 HRc	U SF	480	460	360	250	225
	54 to 60 HRc	H	250				
Stainless steel 303, 410, 420F, 430, 430F, 416	Up to 28 HRc	VA VA SF	840	760	450	450	400
Stainless steel 304, 304L, 420, 17-4PH, 17-7PH, 15-5PH, 13-8PH	up to 28 HRc	VA VA SF	525	475	330	330	250
Stainless steel 310, 316, 316B, 316L, 317, Duplex	over 28 HRc	VA/F VA/F SF	420	380	260	260	200
Titanium Alloys 6Al-4V, 5Al-2.5 Sn, 6Al-2Sn-4Zr-6Mo, 3Al-8V-6Cr-4Mo-4Zr, 10V-2Fe-3Al, 13V-11Cr-3Al	up to 42 HRc	Ti/F VA SF	420	380	260	260	200
High-Temperature Alloys Inconel, Nimonic, Monel, Hastelloy, Waspalloy, A286, Rene 41, Udmet, Stellite	up to 42 HRc	Ti/U VA SF	210	190	130	130	100
Cast iron, grey cast iron, spheroidal graphite and malleable cast iron 0.6010 EN-GL100 (GG10), 0.6020 EN-GJL-200 (GG20), 0.7050 EN-GJS-500-7 (GGG50), 0.8535 EN-GJMW-350-4 (GTW35)	up to 240 HB 30	F U SF	1100	1000	850	620	525
Cast iron, grey cast iron, spheroidal graphite and malleable cast iron 0.6025 EN-GL250 (GG25), 0.6035 EN-GJL-350 (GG35), 0.7070 EN-GJS-700-2 (GGG70), 0.8170 EN-GJMB-700-2 (GTS70)	over 240 HB 30	U VA SF	950	860	720	550	450
Aluminum, Al-wrought alloys, Al-alloys 2024, 6061, 7075, 1050, 6351, 5005, 2017, 7075	up to 3% Si	A	3400	3090	2600	1950	1625
Aluminum-cast alloys 3.2131 G-AISI5Cu1, 3.2153 G-AISI7Cu3, 3.2573 G-AISI9, 3.2581 G-AISI12, 3.2583 G-AISI12Cu, - G-AISI12CuNiMg	over 3% Si	A	1575	1425	1200	1000	750
Magnesium-alloys MgMn2, G-MgAl6Zn1, G-MgAl6Zn3	-	A F SF	1210	1100	920	725	575
Non-ferrous metals (copper, short- or long-chipping brass or bronze)	up to 28 HRc	A F SF	1680	1520	1280	975	800

# FEEDS & SPEEDS FOR RF100 U/HF, VA/NF, A/WF, RS100 U, F

# INCH

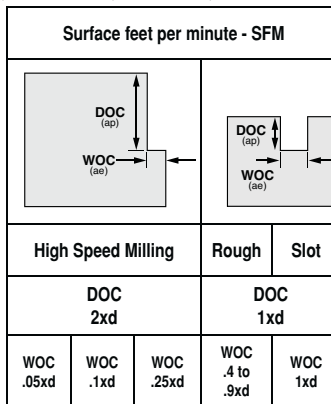
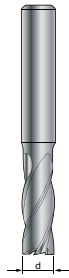

$$RPM = \frac{SFM}{d_1} \times 3.82$$

$$IPM = \text{No. of teeth} \times IPT \times RPM$$

For finishing use WOC (ae) .01 up to .1xd, use SFM from .25xd column, do not increase IPT from table values

Material	Hardness	TYPE	Surface feet per minute - SFM					Feed Rate Inch per Tooth - IPT							
			High Speed Milling		Rough	Slot	d1 End Mill Diameter								
			DOC 2xd		DOC 1xd										
			WOC .05xd	WOC .1xd	WOC .25xd	WOC .4 to .9xd	WOC 1xd	1/8 3.17mm	1/4 6.35mm	5/16 7.94mm	3/8 9.52mm	1/2 12.70mm	5/8 15.87mm	3/4 19.05mm	1 25.40mm
			2.5	2.3	1.5	1	1	Multiply IPT x this factor based on WOC							
Structural + free-cutting steels, unalloyed heat-treatable + case hardened steels A283, 1151, 1215, L10, 10Lxx, 11Lxx, 12Lxx, 41Lxx, 51Lxx, 86Lxx, 86Lxx, 10xx	up to 28 HRc	VA/NF	920	840	700	520	440	.0004	.0008	.0001	.0012	.0016	.0020	.0023	.0032
Free-cutting steels, unalloyed case hardened steels, nitriding steels 1151, 1215, L10, 10Lxx, 11Lxx, 12Lxx, 41Lxx, 51Lxx, 86Lxx, 86Lxx, 10xx, 11xx	28 to 38 HRc	VA/NF	820	740	620	460	390	.0004	.0008	.0001	.0012	.0016	.0020	.0023	.0032
Alloyed heat-treatable, tool and high speed steels 13xx, 2340, 31xx, 32xx, 33xx, 34xx, 40xx, 41xx, 43xx, 4640, 50xx, 51xx, 61xx, 71xx, 86xx, 87xx, 92xx, 98xx, 98xx, Ax, OX, Dx, Hxx, Lx, Wx, Mx, Tx	28 to 44 HRc	U/HF	700	625	525	390	330	.0003	.0005	.0009	.0012	.0016	.0020	.0023	.0032
Hardened Steels Carbon and Alloy Steels, Tool & Die Steels	Up to 54 HRc	U/HF	425	400	290	260	180	.0003	.0005	.0006	.0008	.0011	.0016	.0015	.0024
Stainless steel 303, 410, 420F, 430, 430F, 416	Up to 28 HRc	VA/NF	630	570	360	360	300	.0003	.0007	.0009	.0011	.0015	.0020	.0023	.0032
Stainless steel 304, 304L, 420, 17-4PH, 17-7PH, 15-5PH, 13-8PH	up to 28 HRc	VA/NF	440	400	260	260	210	.0003	.0006	.0008	.0011	.0014	.0016	.0023	.0028
Stainless steel 310, 316, 316B, 316L, 317, Duplex	over 28 HRc	VA/NF	380	340	230	230	180	.0003	.0005	.0007	.0009	.0013	.0016	.0019	.0024
Titanium Alloys 6Al-4V, 5Al-2.5 Sn, 6Al-2Sn-4Zr-6Mo, 3Al-8V-6Cr4Mo-4Zr, 10V-2Fe-3Al, 13V-11Cr-3Al	up to 42 HRc	U/HF VA/NF	340	300	325	230	160	.0003	.0005	.0007	.0009	.0013	.0016	.0019	.0024
High-Temperature Alloys Inconel, Nimonic, Monel, Hastelloy, Waspalloy, A286, Rene 41, Udimet, Stellite	up to 42 HRc	U/HF	170	150	130	130	80	.0003	.0005	.0006	.0008	.0011	.0016	.0015	.0024
Cast iron, grey cast iron, spheroidal graphite and malleable cast iron 0.6010 EN-GL100 (GG10), 0.6020 EN-GJL-200 (GG20), 0.7050 EN-GJS-500-7 (GGG50), 0.8535 EN-GJMW-350-4 (GTW35)	up to 240 HB 30	VA/NF	820	740	620	460	390	.0004	.0008	.0009	.0012	.0016	.0020	.0023	.0032
Cast iron, grey cast iron, spheroidal graphite and malleable cast iron 0.6025 EN-GL250 (GG25), 0.6035 EN-GJL-350 (GG35), 0.7070 EN-GJS-700-2 (GGG70), 0.8170 EN-GJMB-700-2 (GTS70)	over 240 HB 30	U/HF	710	650	540	430	340	.0003	.0007	.0009	.0011	.0015	.0020	.0019	.0032
Aluminum, Al-wrought alloys, Al-alloys 2024, 6061, 7075, 1050, 6351, 5005, 2017, 7075	up to 3% Si	A/WF	2600	2350	2000	1440	1230	.0005	.0009	.0011	.0014	.0018	.0023	.0026	.0036
Aluminium-cast alloys 3.2131 G-AISI5Cu1, 3.2153 G-AISI7Cu3, 3.2573 G-AISI9, 3.2581 G-AISI12, 3.2583 G-AISI12Cu, + G-AISI12CuNiMg	over 3% Si	A/WF	1250	1100	950	690	590	.0004	.0008	.0010	.0013	.0018	.0023	.0026	.0036
Magnesium-alloys MgMn2, G-MgAl8Zn1, G-MgAl6Zn3	-	A/WF	1000	875	740	560	460	.0004	.0008	.0010	.0013	.0018	.0023	.0026	.0036
Non-ferrous metals (copper, short- or long-chipping brass or bronze)	up to 28 HRc	VA/NF	1375	1250	1050	750	660	.0004	.0008	.0010	.0013	.0018	.0023	.0026	.0036

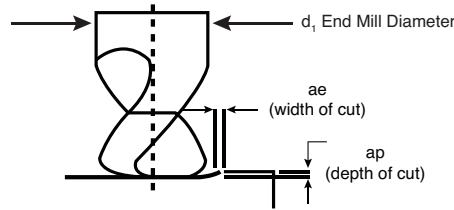

$$RPM = \frac{SFM}{d_1} \times 3.82$$

$$IPM = \text{No. of teeth} \times IPT \times RPM$$

Tool length/reach up to 3xD Vc and fz 100%  
 Tool length/reach 3-5xD Vc and fz 80%  
 Tool length/reach > 5-10xD Vc and fz 60%

Material	Hardness	Application	ap max	ae max	SFM	Feed Rate Inch per Tooth - IPT							
						3mm	4mm	5mm	6mm	8mm	10mm	12mm	16mm
Structural + free-cutting steels, unalloyed heat-treatable + case hardened steels A283, 1151, 1215, L10, 10Lxx, 11Lxx, 12Lxx, 41Lxx, 51Lxx, 86Lxx, 86Lxx, 10xx	up to 28 HRC	Slotting	0.04 x D	1.00 x D	660	0.0041	0.0055	0.0069	0.0094	0.0126	0.0157	0.0189	0.0252
		Roughing	0.06 x D	0.60 x D	820	0.0050	0.0066	0.0083	0.0113	0.0151	0.0189	0.0227	0.0302
		Pre Finishing	0.03 x D	0.40 x D	980	0.0037	0.0050	0.0062	0.0085	0.0113	0.0142	0.0170	0.0227
Free-cutting steels, unalloyed case hardened steels, nitriding steels 1151, 1215, L10, 10Lxx, 11Lxx, 12Lxx, 41Lxx, 51Lxx, 86Lxx, 86Lxx, 10xx, 11xx	28 to 38 HRC	Slotting	0.04 x D	1.00 x D	560	0.0035	0.0047	0.0059	0.0083	0.0110	0.0138	0.0165	0.0220
		Roughing	0.06 x D	0.60 x D	720	0.0043	0.0057	0.0071	0.0099	0.0132	0.0165	0.0198	0.0265
		Pre Finishing	0.03 x D	0.40 x D	820	0.0032	0.0043	0.0053	0.0074	0.0099	0.0124	0.0149	0.0198
Alloyed heat-treatable, tool and high speed steels 13xx, 2340, 31xx, 32xx, 33xx, 34xx, 40xx, 41xx, 43xx, 4640, 50xx, 51xx, 61xx, 71xx, 86xx, 87xx, 92xx, 98xx, 98xx, Ax, Ox, Dx, Hxx, Lx, Wx, Mx, Tx	28 to 44 HRC	Slotting	0.04 x D	1.00 x D	430	0.0030	0.0039	0.0049	0.0071	0.0094	0.0118	0.0142	0.0189
		Roughing	0.05 x D	0.60 x D	560	0.0035	0.0047	0.0059	0.0085	0.0113	0.0142	0.0170	0.0227
		Pre Finishing	0.03 x D	0.40 x D	620	0.0027	0.0035	0.0044	0.0064	0.0085	0.0106	0.0128	0.0170
Hardened Steels Carbon and Alloy Steels, Tool & Die Steels	up to 54 HRC	Slotting	0.03 x D	1.00 x D	330	0.0024	0.0031	0.0039	0.0059	0.0079	0.0098	0.0118	0.0157
		Roughing	0.04 x D	0.40 x D	400	0.0028	0.0038	0.0047	0.0071	0.0094	0.0118	0.0142	0.0189
		Pre Finishing	0.02 x D	0.30 x D	490	0.0021	0.0028	0.0035	0.0053	0.0071	0.0089	0.0106	0.0142
	54-60 HRC	Roughing	0.03 x D	0.30 x D	300	0.0014	0.0019	0.0024	0.0043	0.0057	0.0071	0.0085	0.0113
		Pre Finishing	0.01 x D	0.20 x D	330	0.0011	0.0014	0.0018	0.0032	0.0043	0.0053	0.0064	0.0085
Stainless steel 303, 410, 420F, 430, 430F, 416	Up to 28 HRC	Slotting	0.03 x D	1.00 x D	330	0.0035	0.0047	0.0059	0.0083	0.0110	0.0138	0.0165	0.0220
		Roughing	0.04 x D	0.40 x D	430	0.0043	0.0057	0.0071	0.0099	0.0132	0.0165	0.0198	0.0265
		Pre Finishing	0.02 x D	0.30 x D	490	0.0032	0.0043	0.0053	0.0074	0.0099	0.0124	0.0149	0.0198
Stainless steel 304, 304L, 420, 17-4PH, 17-7PH, 15-5PH, 13-8PH	up to 28 HRC	Slotting	0.03 x D	1.00 x D	260	0.0032	0.0043	0.0053	0.0076	0.0101	0.0126	0.0151	0.0202
		Roughing	0.04 x D	0.40 x D	330	0.0038	0.0051	0.0064	0.0091	0.0121	0.0151	0.0181	0.0242
		Pre Finishing	0.02 x D	0.30 x D	390	0.0029	0.0038	0.0048	0.0068	0.0091	0.0113	0.0136	0.0181
Stainless steel 310, 316, 316B, 316L, 317, Duplex	over 28 HRC	Slotting	0.02 x D	1.00 x D	200	0.0024	0.0031	0.0039	0.0059	0.0079	0.0098	0.0118	0.0157
		Roughing	0.03 x D	0.40 x D	230	0.0028	0.0038	0.0047	0.0071	0.0094	0.0118	0.0142	0.0189
		Pre Finishing	0.02 x D	0.30 x D	300	0.0021	0.0028	0.0035	0.0053	0.0071	0.0089	0.0106	0.0142
Titanium Alloys 6Al-4V, 5Al-2.5 Sn, 6Al-2Sn-4Zr-6Mo, 3Al-8V-6Cr4Mo-4Zr, 10V-2Fe-3Al, 13V-11Cr-3Al	up to 42 HRC	Slotting	0.02 x D	1.00 x D	150	0.0024	0.0031	0.0039	0.0059	0.0079	0.0098	0.0118	0.0157
		Roughing	0.03 x D	0.40 x D	200	0.0028	0.0038	0.0047	0.0071	0.0094	0.0118	0.0142	0.0189
		Pre Finishing	0.02 x D	0.30 x D	230	0.0021	0.0028	0.0035	0.0053	0.0071	0.0089	0.0106	0.0142
High-Temperature Alloys Inconel, Nimonic, Monel, Hastelloy, Waspalloy, A286, Rene 41, Udimet, Stellite	up to 42 HRC	Slotting	0.01 x D	1.00 x D	100	0.0012	0.0016	0.0020	0.0035	0.0047	0.0059	0.0071	0.0094
		Roughing	0.02 x D	0.30 x D	115	0.0014	0.0019	0.0024	0.0043	0.0057	0.0071	0.0085	0.0113
		Pre Finishing	0.01 x D	0.20 x D	130	0.0011	0.0014	0.0018	0.0032	0.0043	0.0053	0.0064	0.0085
Cast iron, grey cast iron, spheroidal graphite and malleable cast iron 0.6010 EN-GL100 (GG10), 0.6020 EN-GJL-200 (GG20), 0.7050 EN-GJS-500-7 (GGG50), 0.8535 EN-GJMW-350-4 (GTW35)	up to 240 HB 30	Slotting	0.04 x D	1.00 x D	560	0.0035	0.0047	0.0059	0.0083	0.0110	0.0138	0.0165	0.0220
		Roughing	0.06 x D	0.60 x D	720	0.0043	0.0057	0.0071	0.0099	0.0132	0.0165	0.0198	0.0265
		Pre Finishing	0.03 x D	0.40 x D	820	0.0032	0.0043	0.0053	0.0074	0.0099	0.0124	0.0149	0.0198
Cast iron, grey cast iron, spheroidal graphite and malleable cast iron 0.6025 EN-GL250 (GG25), 0.6035 EN-GJL-350 (GG35), 0.7070 EN-GJS-700-2 (GGG70), 0.8170 EN-GJMB-700-2 (GTS70)	above 240 HB 30	Slotting	0.04 x D	1.00 x D	460	0.0032	0.0043	0.0053	0.0076	0.0101	0.0126	0.0151	0.0202
		Roughing	0.05 x D	0.60 x D	590	0.0038	0.0051	0.0064	0.0091	0.0121	0.0151	0.0181	0.0242
		Pre Finishing	0.03 x D	0.40 x D	690	0.0029	0.0038	0.0048	0.0068	0.0091	0.0113	0.0136	0.0181
Aluminum, Al-wrought alloys, Al-alloys 2024, 6061, 7075, 1050, 6351, 5005, 2017, 7075	up to 3% Si												
Aluminium-cast alloys 3.2131 G-AISI5Cu1, 3.2153 G-AISI7Cu3, 3.2573 G-AISI9, 3.2581 G-AISI12, 3.2583 G-AISI12Cu, - G-AISI12CuNiMg	above 3% Si												
Magnesium-alloys MgMn2, G-MgAl8Zn1, G-MgAl6Zn3	-												
Non-ferrous metals (copper, short- or long-chipping brass or bronze)	up to 28 HRC												

# GH100 U (Aero-Tech & Finish-Tech 50), GH100 H (Finish-Tech 62), GA200 A (Alumi-Tech)

INCH

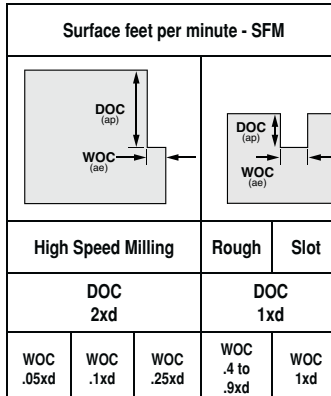
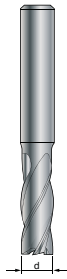

$$RPM = \frac{SFM}{d_1} \times 3.82$$

$$IPM = \text{No. of teeth} \times IPT \times RPM$$

For finishing use WOC (ae) .01 up to .1xd, use SFM from .25xd column, do not increase IPT from table values

Material	Hardness	TYPE	Surface feet per minute - SFM					Feed Rate Inch per Tooth - IPT															
			WOC .05xd	WOC .1xd	WOC .25xd	WOC .4 to .9xd	WOC 1xd	d1 End Mill Diameter															
								1/8 3.17mm	1/4 6.35mm	5/16 7.94mm	3/8 9.52mm	1/2 12.70mm	5/8 15.87mm	3/4 19.05mm	1 25.40mm	Multiply IPT x this factor based on WOC							
			2.5	2.3	1.5	1	1																
Structural + free-cutting steels, unalloyed heat-treatable + case hardened steels A283, 1151, 1215, L10, 10Lxx, 11Lxx, 12Lxx, 41Lxx, 51Lxx, 86Lxx, 86Lxx, 10xx	up to 28 HRC	U (3-Fit.) U (6-/8-Fit.)	840	760	640	530	400	.0005	.0010	.0016	.0017	.0023	.0027	.0034	.0044								
Free-cutting steels, unalloyed case hardened steels, nitriding steels 1151, 1215, L10, 10Lxx, 11Lxx, 12Lxx, 41Lxx, 51Lxx, 86Lxx, 86Lxx, 10xx, 11xx	28 to 38 HRC	U (3-Fit.) U (6-/8-Fit.)	735	665	560	425	350	.0005	.0010	.0016	.0017	.0023	.0027	.0034	.0044								
Alloyed heat-treatable, tool and high speed steels 13xx, 2340, 31xx, 32xx, 33xx, 34xx, 40xx, 41xx, 43xx, 4640, 50xx, 51xx, 61xx, 71xx, 86xx, 87xx, 92xx, 98xx, 98xx, Ax, Ox, Dx, Hxx, Lx, Wx, Mx, Tx	28 to 44 HRC	U (3-Fit.) U (6-/8-Fit.)	630	570	480	360	300	.0005	.0010	.0012	.0016	.0021	.0027	.0030	.0044								
Hardened Steels Carbon and Alloy Steels, Tool & Die Steels	Up to 54 HRC	U (3-Fit.) U (6-/8-Fit.)	300	275	225	180	165	.0004	.0008	.0010	.0013	.0018	.0023	.0026	.0036								
	54 to 60 HRC	U (6-/8-Fit.)	230	Finishing only WOC less than .1xd																			
Stainless steel 303, 410, 420F, 430, 430F, 416	Up to 28 HRC	U (3-Fit.) U (6-/8-Fit.)	564	495	330	330	260	.0005	.0010	.0012	.0016	.0021	.0027	.0019	.0044								
Stainless steel 304, 304L, 420, 17-4PH, 17-7PH, 15-5PH, 13-8PH	up to 28 HRC	U (3-Fit.) U (6-/8-Fit.)	380	340	230	230	180	.0005	.0009	.0011	.0014	.0019	.0023	.0030	.0040								
Stainless steel 310, 316, 316B, 316L, 317, Duplex	over 28 HRC	U (3-Fit.) U (6-/8-Fit.)	275	250	165	165	130	.0004	.0008	.0010	.0013	.0018	.0020	.0026	.0036								
Titanium Alloys 6Al-4V, 5Al-2.5 Sn, 6Al-2Sn-4Zr-6Mo, 3Al-6V-6Cr4Mo-4Zr, 10V-2Fe-3Al, 13V-11Cr-3Al	up to 42 HRC	U (3-Fit.) U (6-/8-Fit.)	275	250	165	165	130	.0004	.0008	.0010	.0014	.0019	.0023	.0030	.0040								
High-Temperature Alloys Inconel, Nimonic, Monel, Hastelloy, Waspalloy, A286, Rene 41, Udimet, Stellite	up to 42 HRC	U (3-Fit.) U (6-/8-Fit.)	135	125	100	100	65	.0003	.0006	.0008	.0011	.0015	.0020	.0023	.0032								
Cast iron, grey cast iron, spheroidal graphite and malleable cast iron 0.6010 EN-GL100 (GG10), 0.6020 EN-GJL-200 (GG20), 0.7050 EN-GJS-500-7 (GGG50), 0.8535 EN-GJMW-350-4 (GTW35)	up to 240 HB 30	U (3-Fit.) U (6-/8-Fit.)	725	655	550	425	345	.0005	.0010	.0013	.0017	.0023	.0027	.0034	.0044								
Cast iron, grey cast iron, spheroidal graphite and malleable cast iron 0.6025 EN-GL250 (GG25), 0.6035 EN-GJL-350 (GG35), 0.7070 EN-GJS-700-2 (GGG70), 0.8170 EN-GJMB-700-2 (GTS70)	over 240 HB 30	U (3-Fit.) U (6-/8-Fit.)	630	570	480	360	300	.0005	.0010	.0012	.0016	.0021	.0027	.0030	.0044								
Aluminum, Al-wrought alloys, Al-alloys 2024, 6061, 7075, 1050, 6351, 5005, 2017, 7075	up to 3% Si	A (2&3-Fit.) U (6-/8-Fit.)	2050	1875	1576	1300	985	.0006	.0013	.0016	.0021	.0028	.0035	.0041	.0056								
Aluminium-cast alloys 3.2131 G-AISI9Cu1, 3.2153 G-AISI7Cu3, 3.2573 G-AISI9, 3.2581 G-AISI12, 3.2583 G-AISI12Cu, - G-AISI12CuNiMg	over 3% Si	A (2&3-Fit.) U (6-/8-Fit.)	1240	1120	945	985	590	.0006	.0011	.0014	.0019	.0025	.0031	.0038	.0052								
Magnesium-alloys MgMn2, G-MgAl6Zn1, G-MgAl6Zn3	—	A (2&3-Fit.) U (6-/8-Fit.)	1050	950	800	590	500	.0005	.0010	.0013	.0017	.0023	.0027	.0034	.0044								
Non-ferrous metals (copper, short- or long-chipping brass or bronze)	up to 28 HRC	A (2&3-Fit.) U (6-/8-Fit.)	1365	1235	1040	750	650	.0006	.0011	.0014	.0019	.0025	.0031	.0038	.0052								

**GS100 A (Rough-Tech Alu), GS100 U (Rough-Tech 48),  
GS100 H (Rough-Tech 56)**

**INCH**

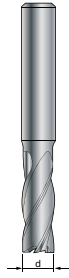

Surface feet per minute - SFM				
High Speed Milling		Rough	Slot	
DOC 2xd		DOC 1xd		
WOC .05xd	WOC .1xd	WOC .25xd	WOC .4 to .9xd	WOC 1xd

$$RPM = \frac{SFM}{d_1} \times 3.82$$

$$IPM = \text{No. of teeth} \times IPT \times RPM$$

For finishing use WOC (ae) .01 up to .1xd, use SFM from .25xd column, do not increase IPT from table values

Feed Rate Inch per Tooth - IPT							
d1 End Mill Diameter							
1/8 3.17mm	1/4 6.35mm	5/16 7.94mm	3/8 9.52mm	1/2 12.70mm	5/8 15.87mm	3/4 19.05mm	1 25.40mm

Material	Hard-ness	TYPE					
			2.5	2.3	1.5	1	1

Multiply IPT x this factor based on WOC							
.0003	.0007	.0009	.0011	.0015	.0020	.0023	.0032
.0003	.0007	.0009	.0011	.0015	.0020	.0023	.0032
.0003	.0006	.0008	.0011	.0014	.0016	.0023	.0028
.0002	.0005	.0005	.0008	.0010	.0012	.0015	.0020
.0003	.0006	.0008	.0011	.0014	.0016	.0023	.0028
.0003	.0005	.0007	.0009	.0013	.0016	.0019	.0024
.0003	.0005	.0006	.0008	.0011	.0016	.0015	.0024
.0003	.0005	.0006	.0008	.0011	.0016	.0015	.0024
.0002	.0005	.0005	.0008	.0010	.0012	.0015	.0020
.0003	.0007	.0009	.0011	.0015	.0020	.0023	.0032
.0003	.0006	.0008	.0011	.0014	.0016	.0023	.0028
.0004	.0008	.0010	.0013	.0018	.0023	.0026	.0036
.0004	.0008	.0009	.0012	.0016	.0020	.0023	.0032
.0004	.0008	.0009	.0012	.0016	.0020	.0023	.0032
.0004	.0008	.0009	.0012	.0016	.0020	.0023	.0032

Structural + free-cutting steels, unalloyed heat-treatable + case hardened steels A283, 1151, 1215, L10, 10Lxx, 11Lxx, 12Lxx, 41Lxx, 51Lxx, 86Lxx, 86Lxx, 10xx	up to 28 HRc	U	820	740	625	460	390
Free-cutting steels, unalloyed case hardened steels, nitriding steels 1151, 1215, L10, 10Lxx, 11Lxx, 12Lxx, 41Lxx, 51Lxx, 86Lxx, 86Lxx, 10xx, 11xx	28 to 38 HRc	U	690	630	530	390	330
Alloyed heat-treatable, tool and high speed steels 13xx, 2340, 31xx, 32xx, 33xx, 34xx, 40xx, 41xx, 43xx, 4640, 50xx, 51xx, 61xx, 71xx, 86xx, 87xx, 92xx, 98xx, 98xx, Ax, Ox, Dx, Hxx, Lx, Wx, Mx, Tx	28 to 44 HRc	U H	620	560	470	360	295
Hardened Steels Carbon and Alloy Steels, Tool & Die Steels	Up to 54 HRc	H	350	315	265	230	165
Stainless steel 303, 410, 420F, 430, 430F, 416	Up to 28 HRc	U	545	495	400	330	260
Stainless steel 304, 304L, 420, 17-4PH, 17-7PH, 15-5PH, 13-8PH	up to 28 HRc	U	380	340	325	230	180
Stainless steel 310, 316, 316B, 316L, 317, Duplex	over 28 HRc	U	350	315	265	230	165
Titanium Alloys 6Al-4V, 5Al-2.5 Sn, 6Al-2Sn-4Zr-6Mo, 3Al-8V-6Cr-4Mo-4Zr, 10V-2Fe-3Al, 13V-11Cr-3Al	up to 42 HRc	U	315	285	250	195	150
High-Temperature Alloys Inconel, Nimonic, Monel, Hastelloy, Waspalloy, A286, Rene 41, Udimet, Stellite	up to 42 HRc	U	135	125	120	100	65
Cast iron, grey cast iron, spheroidal graphite and malleable cast iron 0.6010 EN-GJ100 (GG10), 0.6020 EN-GJL-200 (GG20), 0.7050 EN-GJS-500-7 (GGG50), 0.8535 EN-GJMW-350-4 (GTW35)	up to 240 HB 30	U	695	625	530	395	330
Cast iron, grey cast iron, spheroidal graphite and malleable cast iron 0.6025 EN-GJ250 (GG25), 0.6035 EN-GJL-350 (GG35), 0.7070 EN-GJS-700-2 (GGG70), 0.8170 EN-GJMB-700-2 (GTS70)	over 240 HB 30	H	620	560	470	360	295
Aluminum, Al-wrought alloys, Al-alloys 2024, 6061, 7075, 1050, 6351, 5005, 2017, 7075	up to 3% Si	A	2420	2185	1840	1345	1150
Aluminium-cast alloys 3.2131 G-AISI5Cu1, 3.2153 G-AISI7Cu3, 3.2573 G-AISI9, 3.2581 G-AISI12, 3.2583 G-AISI12Cu, - G-AISI12CuNiMg	over 3% Si	A	1240	1120	945	690	590
Magnesium-alloys MgMn2, G-MgAl8Zn1, G-MgAl6Zn3	-	A	830	750	630	460	395
Non-ferrous metals (copper, short- or long-chipping brass or bronze)	up to 28 HRc	A	1240	1120	945	690	590

# GF500 B & GF300 B Ball nose

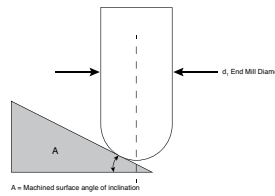

$a_e$  = Width of cut  
 $a_p$  = Depth of cut

INCH

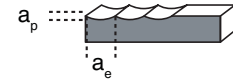

Tool length/reach up to 3xD Vc and fz 100%  
Tool length/reach 3-5xD Vc and fz 80%  
Tool length/reach > 5-10xD Vc and fz 60%

Application	Width/depth	d End Mill Ø							
		1/16	1/8	3/16	1/4	5/16	3/8	1/2	5/8
Roughing	WOC (ae)	.003	.006	.009	.017	.023	.028	.042	.047
	DOC (ap)	.005	.006	.014	.021	.029	.038	.063	.059
Finishing	WOC (ae)	.002	.003	.005	.006	.006	.007	.008	.012
	DOC (ap)	.002	.002	.003	.004	.006	.008	.010	.012

Material	Hardness	Type of End Mill	ae Max	Cutting Speed SFM	Feed Rate Inch per Tooth - IPT							
					d1 End Mill Diameter							
					1/8	1/4	5/16	3/8	1/2	5/8	3/4	1
					Multiply IPT x this factor based on WOC							
Structural + free-cutting steels, unalloyed heat-treatable + case hardened steels A283, 1151, 1215, L10, 10Lxx, 11Lxx, 12Lxx, 41Lxx, 51Lxx, 86Lxx, 86Lxx, 10xx	up to 28 HRc	GF 500 B	0.1 x D	790	.0019	.0038	.0047	.0056	.0075	.0094	.0113	.0150
		GF 500 B	0.03 x D	1120	.0013	.0027	.0033	.0039	.0053	.0069	.0081	.0106
		GF 500 B	0.01 x d	1280	.0011	.0023	.0028	.0034	.0045	.0056	.0069	.0088
Free-cutting steels, unalloyed case hardened steels, nitriding steels 1151, 1215, L10, 10Lxx, 11Lxx, 12Lxx, 41Lxx, 51Lxx, 86Lxx, 86Lxx, 10xx, 11xx	28 to 38 HRc	GF 500 B	0.1 x D	720	.0019	.0038	.0047	.0056	.0075	.0094	.0113	.0150
		GF 500 B	0.03 x D	1020	.0013	.0027	.0033	.0039	.0053	.0069	.0081	.0106
		GF 500 B	0.01 x d	1150	.0013	.0025	.0030	.0037	.0049	.0063	.0075	.0100
Alloyed heat-treatable, tool and high speed steels 13xx, 2340, 31xx, 32xx, 33xx, 34xx, 40xx, 41xx, 43xx, 4640, 50xx, 51xx, 61xx, 71xx, 86xx, 87xx, 92xx, 98xx, 98xx, Ax, OX, Dx, Hxx, Lx, Wx, Mx, Tx	28 to 44 HRc	GF 500 B	0.1 x D	660	.0015	.0030	.0038	.0045	.0060	.0075	.0088	.0119
		GF 500 B	0.03 x D	1020	.0011	.0022	.0027	.0031	.0042	.0050	.0063	.0081
		GF 500 B	0.01 x d	1050	.0010	.0020	.0024	.0029	.0039	.0050	.0056	.0075
Hardened Steels Carbon and Alloy Steels, Tool & Die Steels	Up to 54 HRc	GF 500 B	0.1 x D	430	0.0015	0.0030	0.0038	0.0045	0.0060	0.0075	0.0088	0.0119
		GF 500 B	0.02 x D	660	0.0011	0.0022	0.0027	0.0031	0.0042	0.0050	0.0063	0.0081
	54 to 60 HRc	GF 500 B	0.01 x d	720	0.0009	0.0018	0.0023	0.0027	0.0036	0.0044	0.0056	0.0075
		GF 300 B	0.02 x D	500	0.0009	0.0018	0.0022	0.0026	0.0035	0.0044	0.0050	0.0069
Stainless steel 303, 410, 420F, 430, 430F, 416	Up to 28 HRc	GF 500 B	0.1 x D	530	0.0016	0.0033	0.0041	0.0049	0.0065	0.0081	0.0100	0.0131
		GF 500 B	0.03 x D	762	0.0011	0.0023	0.0028	0.0034	0.0046	0.0056	0.0069	0.0094
		GF 500 B	0.01 x d	850	0.0010	0.0020	0.0024	0.0029	0.0039	0.0050	0.0056	0.0075
Stainless steel 304, 304L, 420, 17-4PH, 17-7PH, 15-5PH, 13-8PH	up to 28 HRc	GF 500 B	0.1 x D	390	0.0015	0.0030	0.0038	0.0045	0.0060	0.0075	0.0088	0.0119
		GF 500 B	0.03 x D	556	0.0011	0.0022	0.0027	0.0031	0.0042	0.0050	0.0063	0.0081
		GF 500 B	0.01 x d	620	0.0009	0.0018	0.0023	0.0027	0.0036	0.0044	0.0056	0.0075
Stainless steel 310, 316, 316B, 316L, 317, Duplex	over 28 HRc	GF 500 B	0.1 x D	260	0.0013	0.0025	0.0031	0.0038	0.0050	0.0063	0.0075	0.0100
		GF 500 B	0.02 x D	390	0.0009	0.0018	0.0022	0.0026	0.0035	0.0044	0.0050	0.0069
		GF 500 B	0.01 x d	460	0.0008	0.0015	0.0019	0.0023	0.0030	0.0038	0.0044	0.0063
Titanium Alloys 6Al-4V, 5Al-2.5 Sn, 6Al-2Sn-4Zr-6Mo, 3Al-8V-6Cr-4Mo-4Zr, 10V-2Fe-3Al, 13V-11Cr-3Al	up to 42 HRc	GF 500 B	0.1 x D	150	0.0013	0.0025	0.0031	0.0038	0.0050	0.0063	0.0075	0.0100
		GF 500 B	0.02 x D	200	0.0009	0.0018	0.0022	0.0026	0.0035	0.0044	0.0050	0.0069
		GF 500 B	0.01 x d	260	0.0008	0.0015	0.0019	0.0023	0.0030	0.0038	0.0044	0.0063
High-Temperature Alloys Inconel, Nimonic, Monel, Hastelloy, Waspalloy, A286, Rene 41, Udimet, Stellite	up to 42 HRc	GF 500 B	0.1 x D	330	0.0015	0.0030	0.0038	0.0045	0.0060	0.0075	0.0088	0.0119
		GF 500 B	0.02 x D	490	0.0011	0.0022	0.0027	0.0031	0.0042	0.0050	0.0063	0.0081
		GF 500 B	0.01 x d	560	0.0009	0.0018	0.0023	0.0027	0.0036	0.0044	0.0056	0.0075
Cast iron, grey cast iron, spheroidal graphite and malleable cast iron 0.6010 EN-GL100 (GG10), 0.6020 EN-GJL-200 (GG20), 0.7050 EN-GJS-500-7 (GGG50), 0.8535 EN-GJMW-350-4 (GTW35)	up to 240 HB 30	GF 500 B	0.1 x D	720	0.0019	0.0038	0.0047	0.0056	0.0075	0.0094	0.0113	0.0150
		GF 500 B	0.03 x D	1020	0.0013	0.0027	0.0033	0.0039	0.0053	0.0069	0.0081	0.0106
		GF 500 B	0.01 x d	1180	0.0011	0.0023	0.0028	0.0034	0.0045	0.0056	0.0069	0.0088
Cast iron, grey cast iron, spheroidal graphite and malleable cast iron 0.6025 EN-GL250 (GG25), 0.6035 EN-GJL-350 (GG35), 0.7070 EN-GJS-700-2 (GGG70), 0.8170 EN-GJMB-700-2 (GTS70)	over 240 HB 30	GF 500 B	0.1 x D	590	0.0016	0.0033	0.0041	0.0049	0.0065	0.0081	0.0100	0.0131
		GF 500 B	0.02 x D	890	0.0011	0.0023	0.0028	0.0034	0.0046	0.0056	0.0069	0.0094
		GF 500 B	0.01 x d	980	0.0010	0.0020	0.0024	0.0029	0.0039	0.0050	0.0056	0.0075
Aluminum, Al-wrought alloys, Al-alloys 2024, 6061, 7075, 1050, 6351, 5005, 2017, 7075	up to 3% Si	GF 500 B	0.1 x D	1976	0.0020	0.0040	0.0050	0.0060	0.0080	0.0100	0.0119	0.0163
		GF 500 B	0.03 x D	2630	0.0014	0.0028	0.0035	0.0042	0.0056	0.0069	0.0081	0.0113
		GF 500 B	0.01 x d	2950	0.0012	0.0024	0.0030	0.0036	0.0048	0.0063	0.0075	0.0094
Aluminium-cast alloys 3.2131 G-AISI5Cu1, 3.2153 G-AISI7Cu3, 3.2573 G-AISI9, 3.2581 G-AISI12, 3.2583 G-AISI12Cu, - G-AISI12CuNiMg	over 3% Si	GF 500 B	0.1 x D	980	0.0019	0.0038	0.0047	0.0056	0.0075	0.0094	0.0113	0.0150
		GF 500 B	0.03 x D	1310	0.0013	0.0027	0.0033	0.0039	0.0053	0.0069	0.0081	0.0106
		GF 500 B	0.01 x d	1640	0.0011	0.0023	0.0028	0.0034	0.0045	0.0056	0.0069	0.0088
Magnesium-alloys MgMn2, G-MgAl8Zn1, G-MgAl6Zn3	-	GF 500 B	0.1 x D	590	0.0016	0.0033	0.0041	0.0049	0.0065	0.0081	0.0100	0.0131
		GF 500 B	0.03 x D	850	0.0011	0.0023	0.0028	0.0034	0.0046	0.0056	0.0069	0.0094
		GF 500 B	0.01 x d	950	0.0010	0.0020	0.0024	0.0029	0.0039	0.0050	0.0056	0.0075
Non-ferrous metals (copper, short- or long-chipping brass or bronze)	up to 28 HRc	GF 500 B	0.1 x D	820	0.0019	0.0038	0.0047	0.0056	0.0075	0.0094	0.0113	0.0150
		GF 500 B	0.03 x D	1150	0.0013	0.0027	0.0033	0.0039	0.0053	0.0069	0.0081	0.0106
		GF 500 B	0.01 x d	1310	0.0011	0.0023	0.0028	0.0034	0.0045	0.0056	0.0069	0.0088



# GF500 T & GF300 T Torus nose / Corner Radius



$RPM = Vc \times 1000 / (3.14 \times d1)$   
 $mm/min = fz \times z \times RPM$

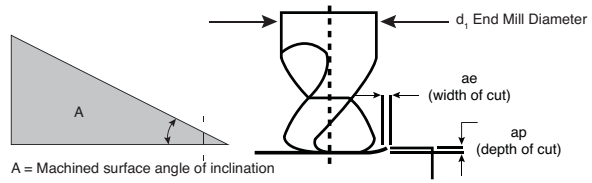

INCH

Tool length/reach up to 3xD Vc and fz 100%  
 Tool length/reach 3-5xD Vc and fz 80%  
 Tool length/reach > 5-10xD Vc and fz 60%

Application	Width/depth	d End Mill Ø							
		1/16	1/8	3/16	1/4	5/16	3/8	1/2	5/8
Roughing	WOC (ae)	.005	.008	.014	.017	.023	.028	.042	.059
	DOC (ap)	.031	.063	.094	.125	.156	.188	.250	.313
Finishing	WOC (ae)	.003	.005	.006	.006	.008	.011	.017	.020
	DOC (ap)	.006	.013	.019	.029	.039	.056	.083	.117

Material	Hardness	Type of End Mill	ae Max	Cutting Speed SFM	Feed Rate Inch per Tooth - IPT							
					d1 End Mill Diameter							
					1/8	1/4	5/16	3/8	1/2	5/8	3/4	1
					Multiply IPT x this factor based on WOC							
Structural + free-cutting steels, unalloyed heat-treatable + case hardened steels A283, 1151, 1215, L10, 10Lxx, 11Lxx, 12Lxx, 41Lxx, 51Lxx, 86Lxx, 86Lxx, 10xx	up to 28 HRc	GF500	0.40 x D	790	.0019	.0038	.0047	.0056	.0075	.0094	.0113	.0150
		GF500	0.25 x D	1120	.0013	.0026	.0033	.0039	.0053	.0069	.0081	.0106
		GF500	0.15 x D	1180	.0013	.0026	.0033	.0039	.0053	.0069	.0081	.0106
Free-cutting steels, unalloyed case hardened steels, nitriding steels 1151, 1215, L10, 10Lxx, 11Lxx, 12Lxx, 41Lxx, 51Lxx, 86Lxx, 86Lxx, 10xx, 11xx	28 to 38 HRc	GF500	0.40 x D	720	.0019	.0038	.0047	.0056	.0075	.0094	.0113	.0150
		GF500	0.25 x D	1020	.0013	.0026	.0033	.0039	.0053	.0069	.0081	.0106
		GF500	0.15 x D	1082	.0013	.0026	.0033	.0039	.0053	.0069	.0081	.0106
Alloyed heat-treatable, tool and high speed steels 13xx, 2340, 31xx, 32xx, 33xx, 34xx, 40xx, 41xx, 43xx, 4640, 50xx, 51xx, 61xx, 71xx, 86xx, 87xx, 92xx, 98xx, 98xx, Ax, Ox, Dx, Hxx, Lx, Wx, Mx, Tx	28 to 44 HRc	GF500	0.40 x D	660	.0015	.0030	.0038	.0045	.0060	.0075	.0088	.0119
		GF500	0.25 x D	620	.0011	.0021	.0027	.0031	.0042	.0050	.0063	.0081
		GF500	0.15 x D	980	.0011	.0021	.0027	.0031	.0042	.0050	.0063	.0081
Hardened Steels Carbon and Alloy Steels, Tool & Die Steels	Up to 54 HRc	GF500	0.30 x D	400	0.0015	0.0030	0.0038	0.0045	0.0060	0.0075	0.0088	0.0119
		GF500	0.20 x D	620	0.0011	0.0021	0.0027	0.0031	0.0042	0.0050	0.0063	0.0081
		GF500	0.15 x D	660	0.0011	0.0021	0.0027	0.0031	0.0042	0.0050	0.0063	0.0081
	54 to 60 HRc	GF300	0.20 x D	490	0.0009	0.0018	0.0022	0.0026	0.0035	0.0044	0.0050	0.0069
		GF300	0.10 x D	530	0.0008	0.0016	0.0020	0.0024	0.0033	0.0044	0.0050	0.0063
		GF500	0.40 x D	530	0.0016	0.0033	0.0041	0.0049	0.0065	0.0081	0.0100	0.0131
Stainless steel 303, 410, 420F, 430, 430F, 416	Up to 28 HRc	GF500	0.25 x D	762	0.0011	0.0023	0.0028	0.0034	0.0046	0.0056	0.0069	0.0094
		GF500	0.15 x D	790	0.0011	0.0023	0.0028	0.0034	0.0046	0.0056	0.0069	0.0094
		GF500	0.30 x D	390	0.0015	0.0030	0.0038	0.0045	0.0060	0.0075	0.0088	0.0119
Stainless steel 304, 304L, 420, 17-4PH, 17-7PH, 15-5PH, 13-8PH	up to 28 HRc	GF500	0.25 x D	556	0.0011	0.0021	0.0027	0.0031	0.0042	0.0050	0.0063	0.0081
		GF500	0.10 x D	620	0.0010	0.0020	0.0024	0.0029	0.0039	0.0050	0.0056	0.0075
		GF500	0.25 x D	260	0.0013	0.0025	0.0031	0.0038	0.0050	0.0063	0.0075	0.0100
Stainless steel 310, 316, 316B, 316L, 317, Duplex	over 28 HRc	GF500	0.20 x D	390	0.0009	0.0018	0.0022	0.0026	0.0035	0.0044	0.0050	0.0069
		GF500	0.10 x D	430	0.0008	0.0016	0.0020	0.0024	0.0033	0.0044	0.0050	0.0063
		GF500	0.25 x D	150	0.0013	0.0025	0.0031	0.0038	0.0050	0.0063	0.0075	0.0100
Titanium Alloys 6Al-4V, 5Al-2.5 Sn, 6Al-2Sn-4Zr-6Mo, 3Al-8V-6Cr4Mo-4Zr, 10V-2Fe-3Al, 13V-11Cr-3Al	up to 42 HRc	GF500	0.20 x D	200	0.0009	0.0018	0.0022	0.0026	0.0035	0.0044	0.0050	0.0069
		GF500	0.10 x D	260	0.0008	0.0016	0.0020	0.0024	0.0033	0.0044	0.0050	0.0063
		GF500	0.30 x D	330	0.0015	0.0030	0.0038	0.0045	0.0060	0.0075	0.0088	0.0119
High-Temperature Alloys Inconel, Nimonic, Monel, Hastelloy, Waspalloy, A286, Rene 41, Udimet, Stellite	up to 42 HRc	GF500	0.20 x D	490	0.0011	0.0021	0.0027	0.0031	0.0042	0.0050	0.0063	0.0081
		GF500	0.15 x D	490	0.0011	0.0021	0.0027	0.0031	0.0042	0.0050	0.0063	0.0081
		GF500	0.40 x D	720	0.0019	0.0038	0.0047	0.0056	0.0075	0.0094	0.0113	0.0150
Cast iron, grey cast iron, spheroidal graphite and malleable cast iron 0.6010 EN-GL100 (GG10), 0.6020 EN-GJL-200 (GG20), 0.7050 EN-GJS-500-7 (GGG50), 0.8535 EN-GJMW-350-4 (GTW35)	up to 240 HB 30	GF500	0.25 x D	1020	0.0013	0.0026	0.0033	0.0039	0.0053	0.0069	0.0081	0.0106
		GF500	0.15 x D	1080	0.0013	0.0026	0.0033	0.0039	0.0053	0.0069	0.0081	0.0106
		GF300	0.40 x D	590	0.0016	0.0033	0.0041	0.0049	0.0065	0.0081	0.0100	0.0131
Cast iron, grey cast iron, spheroidal graphite and malleable cast iron 0.6025 EN-GL250 (GG25), 0.6035 EN-GJL-350 (GG35), 0.7070 EN-GJS-700-2 (GGG70), 0.8170 EN-GJMB-700-2 (GTS70)	over 240 HB 30	GF300	0.25 x D	820	0.0011	0.0023	0.0028	0.0034	0.0046	0.0056	0.0069	0.0094
		GF300	0.15 x D	890	0.0011	0.0023	0.0028	0.0034	0.0046	0.0056	0.0069	0.0094
		GF500	0.40 x D	1976	0.0020	0.0040	0.0050	0.0060	0.0080	0.0100	0.0119	0.0163
Aluminum, Al-wrought alloys, Al-alloys 2024, 6061, 7075, 1050, 6351, 5005, 2017, 7075	up to 3% Si	GF500	0.25 x D	2620	0.0014	0.0028	0.0035	0.0042	0.0056	0.0069	0.0081	0.0113
		GF500	0.15 x D	2950	0.0014	0.0028	0.0035	0.0042	0.0056	0.0069	0.0081	0.0113
		GF500	0.40 x D	980	0.0019	0.0038	0.0047	0.0056	0.0075	0.0094	0.0113	0.0150
Aluminum-cast alloys 3.2131 G-AISI5Cu1, 3.2153 G-AISI7Cu3, 3.2573 G-AISI9, 3.2581 G-AISI12, 3.2583 G-AISI12Cu, - G-AISI12CuNiMg	over 3% Si	GF500	0.25 x D	1310	0.0013	0.0026	0.0033	0.0039	0.0053	0.0069	0.0081	0.0106
		GF500	0.15 x D	1640	0.0013	0.0026	0.0033	0.0039	0.0053	0.0069	0.0081	0.0106
		GF500	0.40 x D	590	0.0016	0.0033	0.0041	0.0049	0.0065	0.0081	0.0100	0.0131
Magnesium-alloys MgMn2, G-MgAl6Zn1, G-MgAl6Zn3	-	GF500	0.25 x D	850	0.0011	0.0023	0.0028	0.0034	0.0046	0.0056	0.0069	0.0094
		GF500	0.15 x D	890	0.0011	0.0023	0.0028	0.0034	0.0046	0.0056	0.0069	0.0094
		GF500	0.40 x D	820	0.0019	0.0038	0.0047	0.0056	0.0075	0.0094	0.0113	0.0150
Non-ferrous metals (copper, short- or long-chipping brass or bronze)	up to 28 HRc	GF500	0.25 x D	1150	0.0013	0.0026	0.0033	0.0039	0.0053	0.0069	0.0081	0.0106
		GF500	0.15 x D	980	0.0013	0.0026	0.0033	0.0039	0.0053	0.0069	0.0081	0.0106

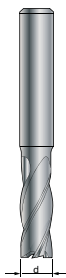

For finishing use WOC (ae) .01 up to .1xd, use SFM from .25xd column, do not increase IPT from table values

Surface feet per minute - SFM				
High Speed Milling		Rough	Slot	
DOC 2xd		DOC 1xd		
WOC .05xd	WOC .1xd	WOC .25xd	WOC .4 to .9xd	WOC 1xd

$$RPM = \frac{SFM}{d_1} \times 3.82$$

$$IPM = \text{No. of teeth} \times IPT \times RPM$$

Feed Rate Inch per Tooth - IPT							
d1 End Mill Diameter							
1/8 3.17mm	1/4 6.35mm	5/16 7.94mm	3/8 9.52mm	1/2 12.70mm	5/8 15.87mm	3/4 19.05mm	1 25.40mm
<b>Multiply IPT x this factor based on WOC</b>							
2.5	2.3	1.5	1	1			
.0005	.0010	.0013	.0016	.0021	.0027	.0030	.0044
.0005	.0010	.0013	.0016	.0021	.0027	.0030	.0044
.0005	.0009	.0011	.0015	.0020	.0023	.0030	.0040
.0003	.0005	.0007	.0009	.0012	.0016	.0019	.0024
.0003	.0007	.0009	.0011	.0015	.0020	.0023	.0032
.0003	.0006	.0007	.0010	.0013	.0016	.0019	.0028
.0003	.0005	.0007	.0009	.0012	.0016	.0019	.0024
.0002	.0004	.0005	.0007	.0009	.0012	.0015	.0020
.0003	.0007	.0009	.0011	.0015	.0020	.0023	.0032
.0005	.0009	.0012	.0015	.0020	.0023	.0030	.0040
.0004	.0008	.0010	.0012	.0017	.0020	.0026	.0032
.0008	.0015	.0020	.0024	.0033	.0039	.0049	.0064
.0007	.0013	.0016	.0021	.0028	.0035	.0041	.0056
.0007	.0013	.0016	.0021	.0028	.0035	.0041	.0056
.0005	.0010	.0013	.0017	.0023	.0027	.0034	.0048

Material	Hardness	TYPE	SFM				
			2.5	2.3	1.5	1	1
Structural + free-cutting steels, unalloyed heat-treatable + case hardened steels A283, 1151, 1215, L10, 10Lxx, 11Lxx, 12Lxx, 41Lxx, 51Lxx, 86Lxx, 86Lxx, 10xx	up to 28 HRc	2, 3, 4 Flute	840	760	640	460	400
Free-cutting steels, unalloyed case hardened steels, nitriding steels 1151, 1215, L10, 10Lxx, 11Lxx, 12Lxx, 41Lxx, 51Lxx, 86Lxx, 86Lxx, 10xx, 11xx	28 to 38 HRc	2, 3, 4 Flute	760	680	580	425	360
Alloyed heat-treatable, tool and high speed steels 13xx, 2340, 31xx, 32xx, 33xx, 34xx, 40xx, 41xx, 43xx, 4640, 50xx, 51xx, 61xx, 71xx, 86xx, 87xx, 92xx, 98xx, 98xx, Ax, OX, Dx, Hxx, Lx, Wx, Mx, Tx	28 to 44 HRc	2, 3, 4 Flute	630	570	480	360	300
Hardened Steels Carbon and Alloy Steels, Tool & Die Steels	Up to 54 HRc	2, 3, 4 Flute	230	200	160	160	115
Stainless steel 303, 410, 420F, 430, 430F, 416	Up to 28 HRc	2, 3, 4 Flute	550	500	325	325	260
Stainless steel 304, 304L, 420, 17-4PH, 17-7PH, 15-5PH, 13-8PH	up to 28 HRc	2, 3, 4 Flute	380	340	230	230	180
Stainless steel 310, 316, 316B, 316L, 317, Duplex	over 28 HRc	2, 3, 4 Flute	320	290	230	230	150
Titanium Alloys 6Al-4V, 5Al-2.5 Sn, 6Al-2Sn-4Zr-6Mo, 3Al-8V-6Cr4Mo-4Zr, 10V-2Fe-3Al, 13V-11Cr-3Al	up to 42 HRc	2, 3, 4 Flute	270	250	165	165	130
High-Temperature Alloys Inconel, Nimonic, Monel, Hastelloy, Waspalloy, A286, Rene 41, Udimet, Stellite	up to 42 HRc	2, 3, 4 Flute	170	150	130	130	80
Cast iron, grey cast iron, spheroidal graphite and malleable cast iron 0.6010 EN-GL100 (GG10), 0.6020 EN-GJL-200 (GG20), 0.7050 EN-GJS-500-7 (GGG50), 0.8535 EN-GJMW-350-4 (GTW35)	up to 240 HB 30	2, 3, 4 Flute	760	680	580	425	360
Cast iron, grey cast iron, spheroidal graphite and malleable cast iron 0.6025 EN-GL250 (GG25), 0.6035 EN-GJL-350 (GG35), 0.7070 EN-GJS-700-2 (GGG70), 0.8170 EN-GJMB-700-2 (GTS70)	over 240 HB 30	2, 3, 4 Flute	650	590	500	360	310
Aluminum, Al-wrought alloys, Al-alloys 2024, 6061, 7075, 1050, 6351, 5005, 2017, 7075	up to 3% Si	2, 3, 4 Flute	2060	1860	1570	1150	980
Aluminium-cast alloys 3.2131 G-AISI5Cu1, 3.2153 G-AISI7Cu3, 3.2573 G-AISI9, 3.2581 G-AISI12, 3.2583 G-AISI12Cu, - G-AISI12CuNiMg	over 3% Si	2, 3, 4 Flute	1100	1000	840	625	525
Magnesium-alloys MgMn2, G-MgAl8Zn1, G-MgAl6Zn3	—	2, 3, 4 Flute	860	780	660	690	410
Non-ferrous metals (copper, short- or long-chipping brass or bronze)	up to 28 HRc	2, 3, 4 Flute	1210	1090	920	950	575



## SLOTING

Material	Hardness	Cutting depth (a <sub>p</sub> )	Cutting width (a <sub>e</sub> )	Cutting speed (v <sub>c</sub> )	fz (mm/z)							
					3	6	8	10	12	16	20	25
Struct./free-cutting steels, unall. heat-treat./case hard. steels	up to 850 N/mm <sup>2</sup>	1 x D	1 x D	270	0.013	0.025	0.034	0.050	0.060	0.080	0.100	0.125
Free-cutting steels, unalloyed case hard. steels, nitr. steels	850 - 1200 N/mm <sup>2</sup>	1 x D	1 x D	230	0.013	0.025	0.034	0.050	0.060	0.080	0.100	0.125
Alloyed heat-treatable, tool and high speed steels	850 - 1400 N/mm <sup>2</sup>	1 x D	1 x D	180	0.011	0.021	0.028	0.045	0.054	0.072	0.090	0.113
Stainless steel - easy to machine / sulphured	up to 750 N/mm <sup>2</sup>	1 x D	1 x D	120	0.011	0.021	0.028	0.045	0.054	0.072	0.090	0.113
Stainless steel - moderately difficult to machine	over 750 - 950 N/mm <sup>2</sup>	1 x D	1 x D	80	0.010	0.019	0.026	0.040	0.048	0.064	0.080	0.100
Titanium, Titanium alloys	up to 1400 N/mm <sup>2</sup>	1 x D	1 x D	60	0.010	0.019	0.026	0.04	0.048	0.064	0.08	0.100
Cast iron, grey cast iron, spher. graphite/malleable cast iron	over 240 HB 30	1 x D	1 x D	150	0.013	0.025	0.034	0.050	0.060	0.080	0.100	0.125
Aluminum, Al-wrought alloys, Al-alloys	up to 7% Si	1 x D	1 x D	500	0.017	0.033	0.044	0.065	0.078	0.104	0.130	0.163
Aluminum-cast alloys	over 7% Si	1 x D	1 x D	340	0.014	0.027	0.036	0.055	0.066	0.088	0.110	0.138

## HIGH-VOLUME ROUGHING

Material	Hardness	Cutting depth (a <sub>p</sub> )	Cutting width (a <sub>e</sub> )	Cutting speed (v <sub>c</sub> )	fz (mm/z)							
					3	6	8	10	12	16	20	25
Struct./free-cutting steels, unall. heat-treat./case hard. steels	up to 850 N/mm <sup>2</sup>	1.5 x D	0.40 x D	350	0.016	0.032	0.042	0.063	0.075	0.100	0.125	0.156
Free-cutting steels, unalloyed case hard. steels, nitr. steels	850 - 1200 N/mm <sup>2</sup>	1.5 x D	0.40 x D	290	0.016	0.032	0.042	0.063	0.075	0.100	0.125	0.156
Alloyed heat-treatable, tool and high speed steels	850 - 1400 N/mm <sup>2</sup>	1.5 x D	0.33 x D	260	0.014	0.027	0.036	0.059	0.070	0.094	0.117	0.146
Stainless steel - easy to machine / sulphured	up to 750 N/mm <sup>2</sup>	1.5 x D	0.33 x D	160	0.014	0.027	0.036	0.059	0.070	0.094	0.117	0.146
Stainless steel - moderately difficult to machine	over 750 - 950 N/mm <sup>2</sup>	1.5 x D	0.25 x D	120	0.014	0.029	0.038	0.060	0.072	0.096	0.120	0.150
Titanium, Titanium alloys	up to 1400 N/mm <sup>2</sup>	1.5 x D	0.33 x D	110	0.012	0.025	0.033	0.052	0.062	0.083	0.104	0.130
Cast iron, grey cast iron, spher. graphite/malleable cast iron	over 240 HB 30	1.5 x D	0.40 x D	190	0.016	0.032	0.042	0.063	0.075	0.100	0.125	0.156
Aluminum, Al-wrought alloys, Al-alloys	up to 7% Si	1.5 x D	0.40 x D	600	0.021	0.041	0.055	0.081	0.098	0.130	0.163	0.203
Aluminum-cast alloys	over 7% Si	1.5 x D	0.40 x D	440	0.017	0.034	0.045	0.069	0.083	0.110	0.138	0.172

## HIGH-SPEED FINISHING

Material	Hardness	Cutting depth (a <sub>p</sub> )	Cutting width (a <sub>e</sub> )	Cutting speed (v <sub>c</sub> )	fz (mm/z)							
					3	6	8	10	12	16	20	25
Struct./free-cutting steels, unall. heat-treat./case hard. steels	up to 850 N/mm <sup>2</sup>	2 x D	0.02 x D	540	0.014	0.028	0.037	0.055	0.066	0.088	0.110	0.138
Free-cutting steels, unalloyed case hard. steels, nitr. steels	850 - 1200 N/mm <sup>2</sup>	2 x D	0.02 x D	460	0.014	0.028	0.037	0.055	0.066	0.088	0.110	0.138
Alloyed heat-treatable, tool and high speed steels	850 - 1400 N/mm <sup>2</sup>	2 x D	0.02 x D	350	0.012	0.023	0.031	0.050	0.059	0.079	0.099	0.124
Stainless steel - easy to machine / sulphured	up to 750 N/mm <sup>2</sup>	2 x D	0.02 x D	220	0.012	0.023	0.031	0.050	0.059	0.079	0.099	0.124
Stainless steel - moderately difficult to machine	over 750 - 950 N/mm <sup>2</sup>	2 x D	0.02 x D	160	0.011	0.021	0.028	0.044	0.053	0.070	0.088	0.110
Titanium, Titanium alloys	up to 1400 N/mm <sup>2</sup>	2 x D	0.02 x D	130	0.011	0.021	0.028	0.044	0.053	0.07	0.088	0.110
Cast iron, grey cast iron, spher. graphite/malleable cast iron	over 240 HB 30	2 x D	0.02 x D	300	0.014	0.028	0.037	0.055	0.066	0.088	0.110	0.138
Aluminum, Al-wrought alloys, Al-alloys	up to 7% Si	2 x D	0.02 x D	1000	0.018	0.036	0.048	0.072	0.086	0.114	0.143	0.179
Aluminum-cast alloys	over 7% Si	2 x D	0.02 x D	680	0.015	0.030	0.040	0.061	0.073	0.097	0.121	0.151



## RAMPING - HELICAL INTERPOLATION

Material	Hardness	Ramping depth* (DOC max.)	Ramping* max. angle in °	Cutting speed (v <sub>c</sub> )	fz (mm/z)							
					3	6	8	10	12	16	20	25
Struct./free-cutting steels, unall. heat-treat./case hard. steels	up to 850 N/mm <sup>2</sup>	1 x D	45°	270	0.011	0.023	0.030	0.045	0.054	0.072	0.090	0.113
Free-cutting steels, unalloyed case hard. steels, nitr. steels	850 - 1200 N/mm <sup>2</sup>	1 x D	45°	230	0.01	0.020	0.026	0.040	0.048	0.064	0.080	0.100
Alloyed heat-treatable, tool and high speed steels	850 - 1400 N/mm <sup>2</sup>	1 x D	30°	180	0.008	0.017	0.022	0.030	0.036	0.048	0.060	0.075
Stainless steel - easy to machine / sulphured	up to 750 N/mm <sup>2</sup>	1 x D	10°	120	0.007	0.014	0.018	0.030	0.036	0.048	0.060	0.075
Stainless steel - moderately difficult to machine	over 750 - 950 N/mm <sup>2</sup>	1 x D	5°	80	0.005	0.011	0.014	0.025	0.030	0.040	0.050	0.063
Titanium, Titanium alloys	up to 1400 N/mm <sup>2</sup>	1 x D	10°	60	0.005	0.011	0.014	0.025	0.03	0.04	0.05	0.063
Cast iron, grey cast iron, spher. graphite/malleable cast iron	over 240 HB 30	1 x D	45°	150	0.011	0.023	0.030	0.045	0.054	0.072	0.090	0.113
Aluminum, Al-wrought alloys, Al-alloys	up to 7% Si	1 x D	30°	500	0.01	0.020	0.026	0.040	0.048	0.064	0.080	0.100
Aluminum-cast alloys	over 7% Si	1 x D	45°	340	0.011	0.023	0.030	0.045	0.054	0.072	0.090	0.113

## DRILLING

Material	Hardness	Drilling depth** (a <sub>p</sub> max.)	Cutting speed (v <sub>c</sub> )	fz (mm/z)							
				3	6	8	10	12	16	20	25
Struct./free-cutting steels, unall. heat-treat./case hard. steels	up to 850 N/mm <sup>2</sup>	2 x D	270	0.011	0.021	0.028	0.040	0.048	0.064	0.080	0.100
Free-cutting steels, unalloyed case hard. steels, nitr. steels	850 - 1200 N/mm <sup>2</sup>	2 x D	240	0.009	0.018	0.024	0.035	0.042	0.056	0.070	0.088
Alloyed heat-treatable, tool and high speed steels	850 - 1400 N/mm <sup>2</sup>	1 x D	200	0.006	0.012	0.016	0.025	0.030	0.040	0.050	0.063
Cast iron, grey cast iron, spher. graphite/malleable cast iron	over 240 HB 30	2 x D	150	0.011	0.021	0.028	0.040	0.048	0.064	0.080	0.100
Aluminum, Al-wrought alloys, Al-alloys	up to 7% Si	1 x D	180	0.009	0.018	0.024	0.035	0.042	0.056	0.070	0.088
Aluminum-cast alloys	over 7% Si	1 x D	140	0.011	0.021	0.028	0.040	0.048	0.064	0.080	0.100

\*Pecking recommended for drilling depths greater than 1xD



## SLOTING

Material	Hardness	max. ap	max. ae	Max. Angle of Engagement	vc	fz by Nominal Diameter									
						3	4	5	6	8	10	12	16	20	25
Struct./free-cutting steels, unall. heat-treat./case hard. steels	up to 28 HRc	0.80 x D	1.00 x D	180°	160	0.014	0.018	0.023	0.027	0.044	0.055	0.066	0.088	0.110	0.138
Alloyed heat-treatable, tool and high speed steels	28 - 44 HRc	0.80 x D	1.00 x D	180°	125	0.014	0.018	0.023	0.027	0.040	0.050	0.060	0.080	0.100	0.125
Stainless steel - easy to machine / sulphured	up to 20 HRc	0.80 x D	1.00 x D	180°	85	0.011	0.014	0.018	0.021	0.028	0.035	0.042	0.056	0.070	0.088
Stainless steel - moderately difficult to machine	20 - 30 HRc	0.80 x D	1.00 x D	180°	55	0.011	0.014	0.018	0.021	0.028	0.035	0.042	0.056	0.070	0.088
Titanium	up to 40 HRc	0.80 x D	1.00 x D	180°	45	0.011	0.014	0.018	0.021	0.028	0.035	0.042	0.056	0.070	0.088
High Temp Alloys Inconel, Nimonic, Hastelloy, Monel	up to 40 HRc	0.80 x D	1.00 x D	180°	30	0.009	0.012	0.015	0.018	0.024	0.030	0.036	0.048	0.060	0.075

## HIGH-VOLUME ROUGHING

Material	Hardness	max. ap	max. ae	Max. Angle of Engagement	vc	fz by Nominal Diameter									
						3	4	5	6	8	10	12	16	20	25
Struct./free-cutting steels, unall. heat-treat./case hard. steels	up to 28 HRc	max a <sub>p</sub> = flute length (l <sub>2</sub> )	0.20 x D	53°	270	0.022	0.029	0.036	0.043	0.070	0.088	0.106	0.141	0.176	0.220
Alloyed heat-treatable, tool and high speed steels	28 - 44 HRc		0.20 x D	53°	210	0.022	0.029	0.036	0.043	0.064	0.080	0.096	0.128	0.160	0.200
Stainless steel - easy to machine / sulphured	up to 20 HRc		0.15 x D	46°	150	0.020	0.027	0.033	0.040	0.053	0.067	0.080	0.106	0.133	0.166
Stainless steel - moderately difficult to machine	20 - 30 HRc		0.10 x D	37°	100	0.024	0.032	0.040	0.048	0.064	0.081	0.097	0.129	0.161	0.201
Titanium	up to 40 HRc		0.08 x D	31°	90	0.026	0.035	0.044	0.053	0.070	0.088	0.105	0.140	0.175	0.219
High Temp Alloys Inconel, Nimonic, Hastelloy, Monel	up to 40 HRc		0.08 x D	31°	60	0.023	0.030	0.038	0.045	0.060	0.075	0.090	0.120	0.150	0.188

## HIGH-SPEED ROUGHING

Material	Hardness	max. ap	max. ae	Max. Angle of Engagement	vc	fz by Nominal Diameter									
						3	4	5	6	8	10	12	16	20	25
Struct./free-cutting steels, unall. heat-treat./case hard. steels	up to 28 HRc	max a <sub>p</sub> = flute length (l <sub>2</sub> )	0.15 x D	46°	290	0.026	0.034	0.043	0.051	0.084	0.105	0.125	0.167	0.209	0.261
Alloyed heat-treatable, tool and high speed steels	28 - 44 HRc		0.15 x D	46°	230	0.026	0.034	0.043	0.051	0.076	0.095	0.114	0.152	0.190	0.238
Stainless steel - easy to machine / sulphured	up to 20 HRc		0.10 x D	37°	170	0.024	0.032	0.040	0.048	0.064	0.081	0.097	0.129	0.161	0.201
Stainless steel - moderately difficult to machine	20 - 30 HRc		0.08 x D	31°	110	0.026	0.035	0.044	0.053	0.070	0.088	0.105	0.140	0.175	0.219
Titanium	up to 40 HRc		0.05 x D	26°	100	0.026	0.035	0.044	0.053	0.070	0.088	0.105	0.140	0.175	0.219
High Temp Alloys Inconel, Nimonic, Hastelloy, Monel	up to 40 HRc		0.05 x D	26°	70	0.023	0.030	0.038	0.045	0.060	0.075	0.090	0.120	0.150	0.188

## HIGH-SPEED FINISHING

Material	Hardness	max. ap	max. ae	Max. Angle of Engagement	vc	fz by Nominal Diameter									
						3	4	5	6	8	10	12	16	20	25
Struct./free-cutting steels, unall. heat-treat./case hard. steels	up to 28 HRc	max a <sub>p</sub> = flute length (l <sub>2</sub> )	0.02 x D	18°	320	0.019	0.025	0.032	0.038	0.062	0.077	0.092	0.123	0.154	0.193
Alloyed heat-treatable, tool and high speed steels	28 - 44 HRc		0.02 x D	18°	250	0.019	0.025	0.032	0.038	0.056	0.070	0.084	0.112	0.140	0.175
Stainless steel - easy to machine / sulphured	up to 20 HRc		0.02 x D	18°	170	0.015	0.020	0.025	0.029	0.039	0.049	0.059	0.078	0.098	0.123
Stainless steel - moderately difficult to machine	20 - 30 HRc		0.01 x D	11°	120	0.019	0.025	0.032	0.038	0.050	0.063	0.076	0.101	0.126	0.158
Titanium	up to 40 HRc		0.01 x D	11°	100	0.019	0.025	0.032	0.038	0.050	0.063	0.076	0.101	0.126	0.158
High Temp Alloys Inconel, Nimonic, Hastelloy, Monel	up to 40 HRc		0.01 x D	11°	70	0.016	0.022	0.027	0.032	0.043	0.054	0.065	0.086	0.108	0.135



## HIGH-VOLUME ROUGHING

Material	Hardness	max. ap	max. ae	Max. Angle of Engagement	vc	fz by Nominal Diameter									
						3	4	5	6	8	10	12	16	20	25
Struct./free-cutting steels, unall. heat-treat./case hard. steels	up to 28 HRc	max $a_p$ = flute length ( $l_2$ )	0.15 x D	46°	280	0.026	0.034	0.043	0.051	0.084	0.105	0.125	0.167	0.209	0.261
Alloyed heat-treatable, tool and high speed steels	28 - 44 HRc		0.15 x D	46°	220	0.026	0.034	0.043	0.051	0.076	0.095	0.114	0.152	0.190	0.238
Stainless steel - easy to machine / sulphured	up to 20 HRc		0.10 x D	37°	160	0.024	0.032	0.040	0.048	0.064	0.081	0.097	0.129	0.161	0.201
Stainless steel - moderately difficult to machine	20 - 30 HRc		0.10 x D	37°	100	0.024	0.032	0.040	0.048	0.064	0.081	0.097	0.129	0.161	0.201
Titanium	up to 40 HRc		0.08 x D	31°	90	0.026	0.035	0.044	0.053	0.070	0.088	0.105	0.140	0.175	0.219
High Temp Alloys Inconel, Nimonic, Hastelloy, Monel	up to 40 HRc		0.08 x D	31°	60	0.023	0.030	0.038	0.045	0.060	0.075	0.090	0.120	0.150	0.188

## HIGH-SPEED ROUGHING

Material	Hardness	max. ap	max. ae	Max. Angle of Engagement	vc	fz by Nominal Diameter									
						3	4	5	6	8	10	12	16	20	25
Struct./free-cutting steels, unall. heat-treat./case hard. steels	up to 28 HRc	max $a_p$ = flute length ( $l_2$ )	0.10 x D	37°	310	0.031	0.041	0.052	0.062	0.101	0.127	0.152	0.202	0.253	0.316
Alloyed heat-treatable, tool and high speed steels	28 - 44 HRc		0.10 x D	37°	240	0.031	0.041	0.052	0.062	0.092	0.115	0.138	0.184	0.230	0.288
Stainless steel - easy to machine / sulphured	up to 20 HRc		0.08 x D	31°	170	0.026	0.035	0.044	0.053	0.070	0.088	0.105	0.140	0.175	0.219
Stainless steel - moderately difficult to machine	20 - 30 HRc		0.08 x D	31°	110	0.026	0.035	0.044	0.053	0.070	0.088	0.105	0.140	0.175	0.219
Titanium	up to 40 HRc		0.05 x D	26°	100	0.026	0.035	0.044	0.053	0.070	0.088	0.105	0.140	0.175	0.219
High Temp Alloys Inconel, Nimonic, Hastelloy, Monel	up to 40 HRc		0.05 x D	26°	70	0.023	0.030	0.038	0.045	0.060	0.075	0.090	0.120	0.150	0.188

## HIGH-SPEED FINISHING

Material	Hardness	max. ap	max. ae	Max. Angle of Engagement	vc	fz by Nominal Diameter									
						3	4	5	6	8	10	12	16	20	25
Struct./free-cutting steels, unall. heat-treat./case hard. steels	up to 28 HRc	max $a_p$ = flute length ( $l_2$ )	0.01 x D	11°	340	0.024	0.032	0.041	0.049	0.079	0.099	0.119	0.158	0.198	0.248
Alloyed heat-treatable, tool and high speed steels	28 - 44 HRc		0.01 x D	11°	270	0.024	0.032	0.041	0.049	0.072	0.090	0.108	0.144	0.180	0.225
Stainless steel - easy to machine / sulphured	up to 20 HRc		0.01 x D	11°	180	0.019	0.025	0.032	0.038	0.050	0.063	0.076	0.101	0.126	0.158
Stainless steel - moderately difficult to machine	20 - 30 HRc		0.01 x D	11°	120	0.019	0.025	0.032	0.038	0.050	0.063	0.076	0.101	0.126	0.158
Titanium	up to 40 HRc		0.01 x D	11°	100	0.019	0.025	0.032	0.038	0.050	0.063	0.076	0.101	0.126	0.158
High Temp Alloys Inconel, Nimonic, Hastelloy, Monel	up to 40 HRc		0.01 x D	11°	70	0.016	0.022	0.027	0.032	0.043	0.054	0.065	0.086	0.108	0.135

Stable conditions:

- good cooling
- sufficient performance
- short-chipping



Application	v <sub>c</sub> factor	f factor	Feed width (ae)	Feed depth (ap)
Slotting	1	1 (0.7 for a <sub>p</sub> = 2xd)	1xd	0.5 up to 1xd
Roughing	1	1 (0.7 for a <sub>p</sub> = 2xd)	0.4 up to 0.9xd	0.5 up to 1xd
Finishing	1	1	0.01 up to 0.1xd	1 up to 2xd
HPC-roughing	1.3	1.5	0.15 up to 0.4xd	1 up to 2xd
HSC-roughing	1.5	2	0.05 up to 0.15xd	1 up to 2xd

Material	Hardness	Recommended RF 100 type	Type of application	cut Vc	fz (mm/z) with nom. Ø							
					3	6	8	10	12	16	20	25
Structural + free-cutting steels, unalloyed heat-treatable + case hardened steels 1.0035 S185, 1.0486 P275N, 1.0345 P235GH, 1.0050, 1.0070, 1.8937 1.0718 11SMnPb30, 1.0736 11SMn37 1.0402 C22, 1.1178 C30E 1.0503 C45, 1.1191 C30E 1.0301 C10, 1.1121 C10E 1.1750 C75W, 1.2076 102Cr6, 1.2307 29CrMoV9	up to 850 N/mm <sup>2</sup>	F	Slotting	180	0.016	0.031	0.042	0.06	0.072	0.01	0.12	0.15
		F	Roughing	210	0.018	0.036	0.048	0.069	0.083	0.011	0.014	0.017
		SF	Finishing	360	0.017	0.034	0.046	0.066	0.079	0.11	0.13	0.17
Free-cutting steels, unalloyed case hardened steels, nitriding steels 1.0727 46 S20, 1.0728 60 S20, 1.0757 46SPb20 1.0601 C60, 1.1221 C60E 1.7043 38Cr4 1.5752 15NiCr13, 1.7131 16MnCr5, 1.7264 20CrMo5 1.8504 34CrAl6 1.8519 31CrMoV9, 1.8550 34CrAlNi7	850-1,200 N/mm <sup>2</sup>	F	Slotting	160	0.014	0.029	0.038	0.055	0.066	0.09	0.11	0.14
		F	Roughing	190	0.017	0.033	0.044	0.063	0.076	0.1	0.13	0.16
		SF	Finishing	320	0.016	0.032	0.042	0.061	0.073	0.1	0.12	0.15
Alloyed heat-treatable, tool and high speed steels 1.5131 50MnSi4, 1.7003 38Cr2, 1.7030 28Cr4 1.5710 36NiCr6, 1.7035 41Cr4, 1.7225 42CrMo4 1.2080 X210Cr12, 1.2083 X42Cr13, 1.2419 105WCr6, 1.2379 X155CrVMo12-1 1.3243 S 6-5-2, 1.3343 S 6-5-2, 1.3344 S 6-5-3 Spring steel = 1.5026 55Si7, 1.7176 55Cr3, 1.8159 51CrV4	850-1,400 N/mm <sup>2</sup>	U	Slotting	135	0.014	0.027	0.036	0.05	0.06	0.08	0.1	0.13
		U	Roughing	160	0.016	0.031	0.041	0.058	0.069	0.09	0.12	0.14
		SF	Finishing	270	0.015	0.03	0.04	0.055	0.066	0.06	0.11	0.14
Hardened steel Tool steel, heat-treatable steel, spring steel, high-speed steel, case hardened steel, etc. Z.B.: 1.2344 X40CrMoV5-1; 1.2767 X45NiCrMo4; 1.2379 X155CrVMo12-1; 1.2080 X210Cr12 1.3343 S 6-5-2	up to 54 HRC	U	Slotting	70	0.011	0.021	0.028	0.04	0.048	0.06	0.08	0.1
		U	Roughing	100	0.014	0.027	0.036	0.052	0.062	0.08	0.1	0.13
	54-60 HRC	SF	Finishing	140	0.011	0.021	0.028	0.04	0.048	0.06	0.08	0.1
		H	Roughing	80	0.021	0.042	0.056	0.075	0.09	0.12	0.15	0.19
		H	Finishing	100	0.008	0.015	0.02	0.027	0.032	0.04	0.05	0.07
Stainless steel 1.4104 X14CrMoS17, 1.4105 X6CrMoS17, 1.4305 X10CrNiS18-9 USA = 303, 410, 420F, 430, 430F	up to 750 N/mm <sup>2</sup>	VA	Slotting	120	0.014	0.027	0.036	0.05	0.06	0.08	0.1	0.13
		VA	Roughing	140	0.016	0.031	0.041	0.058	0.069	0.09	0.12	0.14
		SF	Finishing	240	0.015	0.03	0.04	0.055	0.066	0.09	0.11	0.14
Stainless steel 1.4301 X5CrNi18-10, 1.4303 X5CrNi18-12 1.4310 XCrNi18-8 USA = 304, 304L, 420	750-850 N/mm <sup>2</sup>	VA	Slotting	80	0.012	0.024	0.032	0.045	0.054	0.07	0.09	0.11
		VA	Roughing	100	0.014	0.028	0.037	0.052	0.062	0.08	0.1	0.12
		SF	Finishing	160	0.013	0.026	0.035	0.05	0.059	0.08	0.1	0.12
Stainless steel 1.4438 X2CrNiMo18-15-4, 1.4404 X2CrNiMo17-12-2, 1.4571 X6CrNiTi18-10 USA = 310, 316, 316B, 316L, 317	above 850 N/mm <sup>2</sup>	VA/F	Slotting	60	0.011	0.021	0.028	0.04	0.048	0.06	0.08	0.1
		VA/F	Roughing	80	0.013	0.025	0.034	0.048	0.058	0.08	0.1	0.12
		SF	Finishing	120	0.011	0.021	0.028	0.04	0.048	0.06	0.08	0.1
Special alloys (nickel based "Ni") Nimonic, Inconel, Monel, Hastelloy	up to 1,300 N/mm <sup>2</sup>	Ti/U	Slotting	60	0.008	0.017	0.022	0.032	0.038	0.05	0.06	0.08
		Ti/U	Roughing	80	0.01	0.02	0.027	0.038	0.046	0.06	0.08	0.1
		SF	Finishing	120	0.008	0.017	0.022	0.032	0.038	0.05	0.06	0.08
Titanium alloys ("Ti") 3.7024 Ti99.5, 3.7114 TiAl5Sn2.5, 3.7124 TiCu2 3.7154 TiAl6Zr5, 3.7164 TiAl6V4, 3.7184 TiAl4Mo4Sn2.5	up to 1,300 N/mm <sup>2</sup>	Ti/U	Slotting	30	0.01	0.015	0.02	0.025	0.03	0.04	0.05	0.06
		Ti/U	Roughing	40	0.01	0.02	0.03	0.035	0.04	0.055	0.065	0.08
		SF	Finishing	60	0.015	0.025	0.035	0.045	0.05	0.065	0.08	0.12
Cast iron, grey cast iron, spheroidal graphite and malleable cast iron 0.6010 EN-GL100 (GG10), 0.6020 EN-GJL-200 (GG20), 0.7050 EN-GJS-500-7 (GGG50), 0.8535 EN-GJMW-350-4 (GTW35)	up to 240 HB 30	F	Slotting	160	0.017	0.033	0.044	0.065	0.078	0.1	0.13	0.16
		F	Roughing	190	0.019	0.038	0.051	0.075	0.09	0.12	0.15	0.19
		SF	Finishing	320	0.018	0.036	0.048	0.072	0.086	0.11	0.14	0.18
Cast iron, grey cast iron, spheroidal graphite and malleable cast iron 0.6025 EN-GL250 (GG25), 0.6035 EN-GJL-350 (GG35), 0.7070 EN-GJS-700-2 (GGG70), 0.8170 EN-GJMB-700-2 (GTS70)	above 240 HB 30	U	Slotting	140	0.015	0.03	0.04	0.055	0.066	0.09	0.11	0.14
		U	Roughing	170	0.017	0.035	0.046	0.063	0.076	0.1	0.13	0.16
		SF	Finishing	280	0.017	0.033	0.044	0.061	0.073	0.1	0.12	0.15
Aluminum, Al-wrought alloys, Al-alloys 3.0255 Al99.5, 3.2315 AlMgSi1, 3.3515 AlMg1 3.0615 AlMgSiPb, 3.1325 AlCuMg1, 3.3245 AlMg3Si, 3.4365 AlZnMgCu1.5	up to 3% Si	A	Slotting	500	0.02	0.039	0.052	0.08	0.096	0.13	0.16	0.2
		A	Roughing	600	0.022	0.045	0.06	0.092	0.11	0.15	0.18	0.23
		A	Finishing	1000	0.021	0.043	0.057	0.088	0.106	0.14	0.18	0.22
Aluminum-cast alloys 3.2131 G-AISi5Cu1, 3.2153 G-AISi7Cu3, 3.2573 G-AISi9 3.2581 G-AISi12, 3.2583 G-AISi12Cu, - G-AISi12CuNiMg	above 3% Si	A	Slotting	230	0.017	0.033	0.044	0.06	0.072	0.1	0.12	0.15
		A	Roughing	280	0.019	0.038	0.051	0.069	0.083	0.11	0.14	0.17
		A	Finishing	350	0.018	0.036	0.048	0.066	0.079	0.11	0.13	0.17
Magnesium-alloys MgMn2, G-MgAl8Zn1, G-MgAl6Zn3	-	A	Slotting	180	0.015	0.03	0.04	0.055	0.066	0.09	0.11	0.14
		A	Roughing	210	0.017	0.035	0.046	0.063	0.076	0.1	0.13	0.16
		A	Finishing	360	0.017	0.033	0.044	0.061	0.073	0.1	0.12	0.15
Non-ferrous metals (copper, short- or long-chipping brass or bronze) 2.0070 SE-Cu, 2.1020 CuSn6, 2.1096 G-CuSn5ZnPb 2.0380 CuZn39Pb2, 2.0401 CuZn39Pb3, 2.0410 CuZn43Pb2 2.0250 CuZn20, 2.0280 CuZn33, 2.0332 CuZn37Pb0.5 2.1090 CuSn7ZnPb, 2.1170 CuPb5Sn5, 2.1176 CuPb10Sn 2.0916 CuAl5, 2.0960 CuAl9Mn, 2.1050 CuSn10	up to 850 N/mm <sup>2</sup>	A	Slotting	250	0.017	0.033	0.044	0.06	0.072	0.1	0.12	0.15
		A	Roughing	290	0.019	0.038	0.051	0.069	0.083	0.11	0.14	0.17
		SF	Finishing	500	0.018	0.036	0.048	0.066	0.079	0.11	0.13	0.17

All recommendations are valid for coated tools. For bright milling cutters please vc - 40% and fz -25%

Unstable conditions:

- standard cooling
- average performance
- medium- to long-chipping



Application	v <sub>p</sub> factor	f <sub>z</sub> factor	Feed width (ae)	Feed depth (ap)
Slotting	1	1 (0.7 for a <sub>p</sub> = 2xd)	1xd	0.5 up to 1xd
Roughing	1	1 (0.7 for a <sub>p</sub> = 2xd)	0.4 up to 0.9xd	0.5 up to 1xd
Finishing	1	1	0.01 up to 0.1xd	1 up to 2xd
HPC-roughing	1.3	1.5	0.15 up to 0.4xd	1 up to 2xd
HSC-roughing	1.5	2	0.05 up to 0.15xd	1 up to 2xd

Material	Hardness	Recommended RF 100 type	Type of application	cut Vc	fz (mm/z) with nom. Ø							
					3	6	8	10	12	16	20	25
<b>Structural + free-cutting steels, unalloyed heat-treatable + case hardened steels</b> 1.0035 S185, 1.0486 P275N, 1.0345 P235GH, 1.0050, 1.0070, 1.8937 1.0718 11SMnPb30, 1.0736 11SMn37 1.0402 C22, 1.1178 C30E 1.0503 C45, 1.1191 C30E 1.0301 C10, 1.1121 C10E 1.1750 C75W, 1.2076 102Cr6, 1.2307 29CrMoV9	up to 850 N/mm <sup>2</sup>	VA/NF	Slotting	135	0.009	0.018	0.0024	0.032	0.038	0.05	0.06	0.08
		VA/NF	Roughing	160	0.01	0.021	0.028	0.037	0.044	0.06	0.07	0.09
			Finishing									
<b>Free-cutting steels, unalloyed case hardened steels, nitriding steels</b> 1.0727 46 S20, 1.0728 60 S20, 1.0757 46SPb20 1.0601 C60, 1.1221 C60E 1.7043 38Cr4 1.5752 15NiCr13, 1.7131 16MnCr5, 1.7264 20CrMo5 1.8504 34CrAl6 1.8519 31CrMoV9, 1.8550 34CrAlNi7	850-1,200 N/mm <sup>2</sup>	VA/NF	Slotting	120	0.009	0.018	0.0024	0.032	0.038	0.05	0.06	0.08
		VA/NF	Roughing	140	0.01	0.021	0.028	0.037	0.044	0.06	0.07	0.09
			Finishing									
<b>Alloyed heat-treatable, tool and high speed steels</b> 1.5131 50MnSi4, 1.7003 38Cr2, 1.7030 28Cr4 1.5710 36NiCr6, 1.7035 41Cr4, 1.7225 42CrMo4 1.2080 X210Cr12, 1.2083 X42Cr13, 1.2419 105WCr6, 1.2379 X155CrVmo12-1 1.3243 S 6-5-2-5, 1.3343 S 6-5-2, 1.3344 S 6-5-3 Spring steel = 1.5026 55Si7, 1.7176 55Cr3, 1.8159 51CrV4	850-1,400 N/mm <sup>2</sup>	U/HF	Slotting	100	0.008	0.011	0.024	0.032	0.038	0.05	0.06	0.08
		U/HF	Roughing	120	0.01	0.019	0.026	0.035	0.041	0.06	0.07	0.09
<b>Hardened steel</b> Tool steel, heat-treatable steel, spring steel, high-speed steel, case hardened steel, etc. Z.B.: 1.2344 X40CrMoV5-1; 1.2767 X45NiCrMo4; 1.2379 X155CrVmo12-1 ;1.2080 X210Cr12 1.3343 S 6-5-2	up to 54 HRC	U/HF	Slotting	55	0.006	0.012	0.016	0.022	0.026	0.04	0.04	0.06
		U/HF	Roughing	80	0.008	0.016	0.021	0.029	0.034	0.05	0.06	0.07
<b>Stainless steel</b> 1.4104 X14CrMoS17, 1.4105 X6CrMoS17, 1.4305 X10CrNiS18-9 USA = 303, 410, 420F, 430, 430F	up to 750 N/mm <sup>2</sup>	VA/NF	Slotting	90	0.008	0.017	0.022	0.03	0.036	0.05	0.06	0.08
		VA/NF	Roughing	110	0.01	0.019	0.026	0.035	0.041	0.06	0.07	0.09
			Finishing									
<b>Stainless steel</b> 1.4301X5CrNi18-10, 1.4303 X5CrNi18-12 1.4310 XCrNi18-8 USA = 304, 304L, 420	750-850 N/mm <sup>2</sup>	VA/NF	Slotting	65	0.008	0.015	0.02	0.028	0.034	0.04	0.06	0.07
		VA/NF	Roughing	80	0.009	0.017	0.023	0.032	0.039	0.05	0.06	0.08
			Finishing									
<b>Stainless steel</b> 1.4438 X2CrNiMo18-15-4, 1.4404 X2CrNiMo17-12-2, 1.4571 X6CrNiTi18-10 USA = 310, 316, 316B, 316L, 317	above 850 N/mm <sup>2</sup>	VA/NF	Slotting	55	0.007	0.013	0.018	0.025	0.03	0.04	0.05	0.06
		VA/NF	Roughing	70	0.008	0.016	0.021	0.03	0.036	0.05	0.06	0.08
			Finishing									
<b>Special alloys (nickel based "Ni")</b> Nimonic, Inconel, Monel, Hastelloy	up to 1,300 N/mm <sup>2</sup>	U/HF	Slotting	50	0.007	0.013	0.018	0.025	0.03	0.04	0.05	0.06
		U/HF	Roughing	70	0.008	0.016	0.021	0.03	0.036	0.05	0.06	0.08
<b>Titanium alloys ("Ti")</b> 3.7024 Ti99.5, 3.7114 TiAl5Sn2.5, 3.7124 TiCu2 3.7154 TiAl6Zr5, 3.7164 TiAl6V4, 3.7184 TiAl4Mo4Sn2.5	up to 1,300 N/mm <sup>2</sup>	U/HF	Slotting	25	0.006	0.012	0.016	0.022	0.026	0.04	0.04	0.06
		U/HF	Roughing	40	0.007	0.014	0.019	0.026	0.032	0.04	0.05	0.07
<b>Cast iron, grey cast iron, spheroidal graphite and malleable cast iron</b> 0.6010 EN-GL100 (GG10), 0.6020 EN-GJL-200 (GG20), 0.7050 EN-GJS-500-7 (GGG50), 0.8535 EN-GJMW-350-4 (GTW35)	up to 240 HB 30	VA/NF	Slotting	120	0.009	0.018	0.024	0.032	0.038	0.05	0.06	0.08
		VA/NF	Roughing	140	0.01	0.021	0.028	0.037	0.044	0.06	0.07	0.09
			Finishing									
<b>Cast iron, grey cast iron, spheroidal graphite and malleable cast iron</b> 0.6025 EN-GL250 (GG25), 0.6035 EN-GJL-350 (GG35), 0.7070 EN-GJS-700-2 (GGG70), 0.8170 EN-GJMB-700-2 (GTS70)	above 240 HB 30	U/HF	Slotting	105	0.008	0.017	0.022	0.03	0.036	0.05	0.05	0.08
		U/HF	Roughing	130	0.01	0.019	0.026	0.035	0.041	0.06	0.07	0.09
			Finishing									
<b>Aluminum, Al-wrought alloys, Al-alloys</b> 3.0255 Al99.5, 3.2315 AlMgSi1, 3.3515 AlMg1 3.0615 AlMgSiPb, 3.1325 AlCuMg1, 3.3245 AlMg3Si, 3.4365 AlZnMgCu1.5	up to 3% Si	A/WF	Slotting	375	0.011	0.021	0.028	0.037	0.044	0.06	0.07	0.09
		A/WF	Roughing	440	0.012	0.024	0.032	0.043	0.051	0.07	0.09	0.11
			Finishing									
<b>Aluminum-cast alloys</b> 3.2131 G-AlSi5Cu1, 3.2153 G-AlSi7Cu3, 3.2573 G-AlSi9 3.2581 G-AlSi12, 3.2583 G-AlSi12Cu, - G-AlSi12CuNiMg	above 3% Si	A/WF	Slotting	180	0.01	0.019	0.026	0.035	0.042	0.06	0.07	0.09
		A/WF	Roughing	210	0.011	0.022	0.029	0.04	0.048	0.06	0.08	0.1
			Finishing									
<b>Magnesium-alloys</b> MgMn2, G-MgAl8Zn1, G-MgAl6Zn3	-	A/WF	Slotting	140	0.01	0.019	0.026	0.035	0.042	0.06	0.07	0.09
		A/WF	Roughing	170	0.011	0.022	0.029	0.04	0.048	0.06	0.08	0.1
			Finishing									
<b>Non-ferrous metals (copper, short- or long-chipping brass or bronze)</b> 2.0070 SE-Cu, 2.1020 CuSn6, 2.1096 G-CuSn5ZnPb 2.0380 CuZn39Pb2, 2.0401 CuZn39Pb3, 2.0410 CuZn43Pb2 2.0250 CuZn20, 2.0280 CuZn33, 2.0332 CuZn37Pb0.5 2.1090 CuSn7ZnPb, 2.1170 CuPb5Sn5, 2.1176 CuPb10Sn 2.0916 CuAl5, 2.0960 CuAl9Mn, 2.1050 CuSn10	up to 850 N/mm <sup>2</sup>	VA/NF	Slotting	200	0.01	0.019	0.026	0.035	0.042	0.06	0.07	0.09
		VA/NF	Roughing	230	0.011	0.022	0.029	0.04	0.048	0.06	0.08	0.1

All recommendations are valid for coated tools. For bright milling cutters please vc - 40% and fz - 25%



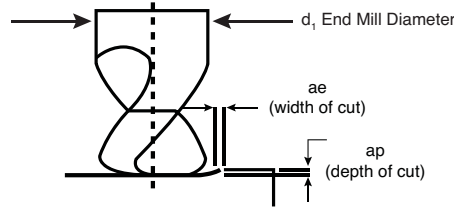

$$RPM = \frac{SFM}{d_1} \times 3.82$$

$$IPM = \text{No. of teeth} \times IPT \times RPM$$

Tool length/reach up to 3xD Vc and fz 100%  
 Tool length/reach 3-5xD Vc and fz 80%  
 Tool length/reach > 5-10xD Vc and fz 60%

Material	Hardness	Application	ap max	ae max	cut Vc	fz (mm/z) with nom. Ø							
						3mm	4mm	5mm	6mm	8mm	10mm	12mm	16mm
Structural + free-cutting steels, unalloyed heat-treatable + case hardened steels 1.0035 S185, 1.0486 P275N, 1.0345 P235GH, 1.0050, 1.0070, 1.8937 1.0718 11SMnPb30, 1.0736 11SMn37 1.0402 C22, 1.1178 C30E 1.0503 C45, 1.1191 C30E 1.0301 C10, 1.1121 C10E 1.1750 C75W, 1.2076 102Cr6, 1.2307 29CrMoV9	up to 850 N/mm <sup>2</sup>	Slotting	0.04 x D	1.00 x D	200	0.105	0.140	0.175	0.240	0.320	0.400	0.480	0.640
		Roughing	0.06 x D	0.60 x D	250	0.126	0.168	0.210	0.288	0.384	0.480	0.576	0.768
		Pre Finishing	0.03 x D	0.40 x D	300	0.095	0.126	0.158	0.216	0.288	0.360	0.432	0.576
Free-cutting steels, unalloyed case hardened steels, nitriding steels 1.0727 46 S20, 1.0728 60 S20, 1.0757 46SPb20 1.0601 C60, 1.1221 C60E 1.7043 38Cr4 1.5752 15NiCr13, 1.7131 16MnCr5, 1.7264 20CrMo5 1.8504 34CrAl6 1.8519 31CrMoV9, 1.8550 34CrAlNi7	850-1,200 N/mm <sup>2</sup>	Slotting	0.04 x D	1.00 x D	170	0.090	0.120	0.150	0.210	0.280	0.350	0.420	0.560
		Roughing	0.06 x D	0.60 x D	220	0.108	0.144	0.180	0.252	0.336	0.420	0.504	0.672
		Pre Finishing	0.03 x D	0.40 x D	250	0.081	0.108	0.135	0.189	0.252	0.315	0.378	0.504
Alloyed heat-treatable, tool and high speed steels 1.5131 50MnSi4, 1.7003 38Cr2, 1.7030 28Cr4 1.5710 36NiCr6, 1.7035 41Cr4, 1.7225 42CrMo4 1.2080 X210Cr12, 1.2083 X42Cr13, 1.2419 105WCr6, 1.2379 X155CrVMo12-1 1.3243 S 6-5-2-5, 1.3343 S 6-5-2, 1.3344 S 6-5-3 Spring steel = 1.5026 55Si7, 1.7176 55Cr3, 1.8159 51CrV4	850-1,400 N/mm <sup>2</sup>	Slotting	0.04 x D	1.00 x D	130	0.075	0.100	0.125	0.180	0.240	0.300	0.360	0.480
		Roughing	0.05 x D	0.60 x D	170	0.090	0.120	0.150	0.216	0.288	0.360	0.432	0.576
		Pre Finishing	0.03 x D	0.40 x D	190	0.068	0.090	0.113	0.162	0.216	0.270	0.324	0.432
Hardened steel Tool steel, heat-treatable steel, spring steel, high-speed steel, case hardened steel, etc. Z.B.: 1.2344 X40CrMoV5-1; 1.2767 X45NiCrMo4; 1.2379 X155CrVMo12-1; 1.2080 X210Cr12 1.3343 S 6-5-2	up to 54 HRC	Slotting	0.03 x D	1.00 x D	100	0.060	0.080	0.100	0.150	0.200	0.250	0.300	0.400
		Roughing	0.04 x D	0.40 x D	120	0.072	0.096	0.120	0.180	0.240	0.300	0.360	0.480
		Pre Finishing	0.02 x D	0.30 x D	150	0.054	0.072	0.090	0.135	0.180	0.225	0.270	0.360
	54-60 HRC	Roughing	0.03 x D	0.30 x D	90	0.036	0.048	0.060	0.108	0.144	0.180	0.216	0.288
		Pre Finishing	0.01 x D	0.20 x D	100	0.027	0.036	0.045	0.081	0.108	0.135	0.162	0.216
Stainless steel 1.4104 X14CrMoS17, 1.4105 X6CrMoS17, 1.4305 X10CrNiS18-9 USA = 303, 410, 420F, 430, 430F	up to 750 N/mm <sup>2</sup>	Slotting	0.03 x D	1.00 x D	100	0.090	0.120	0.150	0.210	0.280	0.350	0.420	0.560
		Roughing	0.04 x D	0.40 x D	130	0.108	0.144	0.180	0.252	0.336	0.420	0.504	0.672
		Pre Finishing	0.02 x D	0.30 x D	150	0.081	0.108	0.135	0.189	0.252	0.315	0.378	0.504
Stainless steel 1.4438 X2CrNiMo18-10, 1.4303 X5CrNi18-12 1.4310 XCrNi18-8 USA = 304, 304L, 420	750-850 N/mm <sup>2</sup>	Slotting	0.03 x D	1.00 x D	80	0.081	0.108	0.135	0.192	0.256	0.320	0.384	0.512
		Roughing	0.04 x D	0.40 x D	100	0.097	0.130	0.162	0.230	0.307	0.384	0.461	0.614
		Pre Finishing	0.02 x D	0.30 x D	120	0.073	0.097	0.122	0.173	0.230	0.288	0.346	0.461
Stainless steel 1.4438 X2CrNiMo18-15-4, 1.4404 X2CrNiMo17-12-2, 1.4571 X6CrNiTi18-10 USA = 310, 316, 316B, 316L, 317	above 850 N/mm <sup>2</sup>	Slotting	0.02 x D	1.00 x D	60	0.060	0.080	0.100	0.150	0.200	0.250	0.300	0.400
		Roughing	0.03 x D	0.40 x D	70	0.072	0.096	0.120	0.180	0.240	0.300	0.360	0.480
		Pre Finishing	0.02 x D	0.30 x D	90	0.054	0.072	0.090	0.135	0.180	0.225	0.270	0.360
Special alloys (nickel based "Ni") Inimonic, Inconel, Monel, Hastelloy	up to 1,300 N/mm <sup>2</sup>	Slotting	0.02 x D	1.00 x D	45	0.060	0.080	0.100	0.150	0.200	0.250	0.300	0.400
		Roughing	0.03 x D	0.40 x D	60	0.072	0.096	0.120	0.180	0.240	0.300	0.360	0.480
		Pre Finishing	0.02 x D	0.30 x D	70	0.054	0.072	0.090	0.135	0.180	0.225	0.270	0.360
Titanium alloys ("Ti") 3.7024 Ti99.5, 3.7114 TiAl5Sn2.5, 3.7124 TiCu2 3.7154 TiAl6Zr5, 3.7164 TiAl6V4, 3.7184 TiAl4Mo4Sn2.5	up to 1,300 N/mm <sup>2</sup>	Slotting	0.01 x D	1.00 x D	30	0.030	0.040	0.050	0.090	0.120	0.150	0.180	0.240
		Roughing	0.02 x D	0.30 x D	35	0.036	0.048	0.060	0.108	0.144	0.180	0.216	0.288
		Pre Finishing	0.01 x D	0.20 x D	40	0.027	0.036	0.045	0.081	0.108	0.135	0.162	0.216
Cast iron, grey cast iron, spheroidal graphite and malleable cast iron 0.6010 EN-GL100 (GG10), 0.6020 EN-GJL-200 (GG20), 0.7050 EN-GJS-500-7 (GGG50), 0.8535 EN-GJMW-350-4 (GTW35)	up to 240 HB 30	Slotting	0.04 x D	1.00 x D	170	0.090	0.120	0.150	0.210	0.280	0.350	0.420	0.560
		Roughing	0.06 x D	0.60 x D	220	0.108	0.144	0.180	0.252	0.336	0.420	0.504	0.672
		Pre Finishing	0.03 x D	0.40 x D	250	0.081	0.108	0.135	0.189	0.252	0.315	0.378	0.504
Cast iron, grey cast iron, spheroidal graphite and malleable cast iron 0.6025 EN-GL250 (GG25), 0.6035 EN-GJL-350 (GG35), 0.7070 EN-GJS-700-2 (GGG70), 0.8170 EN-GJMB-700-2 (GTS70)	above 240 HB 30	Slotting	0.04 x D	1.00 x D	140	0.081	0.108	0.135	0.192	0.256	0.320	0.384	0.512
		Roughing	0.05 x D	0.60 x D	180	0.097	0.130	0.162	0.230	0.307	0.384	0.461	0.614
		Pre Finishing	0.03 x D	0.40 x D	210	0.073	0.097	0.122	0.173	0.230	0.288	0.346	0.461
Aluminum, Al-wrought alloys, Al-alloys 3.0255 Al99.5, 3.2315 AlMgSi1, 3.3515 AlMg1 3.0615 AlMgSiPb, 3.1325 AlCuMg1, 3.3245 AlMg3Si, 3.4365 AlZnMgCu1.5	up to 3% Si												
Aluminum-cast alloys 3.2131 G-AlSi5Cu1, 3.2153 G-AlSi7Cu3, 3.2573 G-AlSi9 3.2581 G-AlSi12, 3.2583 G-AlSi12Cu, - G-AlSi12CuNiMg	above 3% Si												
Magnesium-alloys MgMn2, G-MgAl8Zn1, G-MgAl6Zn3	-												
Non-ferrous metals (copper, short- or long-chipping brass or bronze) 2.0070 SE-Cu, 2.1020 CuSn6, 2.1096 G-CuSn5ZnPb 2.0380 CuZn39Pb2, 2.0401 CuZn39Pb3, 2.0410 CuZn43Pb2 2.0250 CuZn20, 2.0280 CuZn33, 2.0332 CuZn37Pb0.5 2.1090 CuSn7ZnPb, 2.1170 CuPb5Sn5, 2.1176 CuPb10Sn 2.0916 CuAl5, 2.0960 CuAl9Mn, 2.1050 CuSn10	up to 850 N/mm <sup>2</sup>												



Application	v <sub>c</sub> factor	f <sub>z</sub> factor	Feed width (ae)	Feed depth (ap)
Slotting	1	1 (0.7 for a <sub>e</sub> = 2xd)	1xd	0.5 up to 1xd
Roughing	1	1 (0.7 for a <sub>e</sub> = 2xd)	0.4 up to 0.9xd	0.5 up to 1xd
Finishing	1	1	0.01 up to 0.1xd	1 up to 2xd
HPC-roughing	1.3	1.5	0.15 up to 0.4xd	1 up to 2xd
HSC-roughing	1.5	2	0.05 up to 0.15xd	1 up to 2xd

Material	Hardness	Recom- mended GH 100 type	Type of applica- tion	cut Vc	fz (mm/z) with nom. Ø							
					3	6	8	10	12	16	20	25
<b>Structural + free-cutting steels, unalloyed heat-treatable + case hardened steels</b> 1.0035 S185, 1.0486 P275N, 1.0345 P235GH, 1.0050, 1.0070, 1.8937 1.0718 11SMnPb30, 1.0736 11SMn37 1.0402 C22, 1.1178 C30E 1.0503 C45, 1.1191 C30E 1.0301 C10, 1.1121 C10E 1.1750 C75W, 1.2076 102Cr6, 1.2307 29CrMoV9	up to 850 N/mm <sup>2</sup>	U (3-Fit.)	Slotting	120	0.012	0.024	0.041	0.045	0.054	0.070	0.090	0.110
		U (3-Fit.)	Roughing	140	0.014	0.028	0.037	0.052	0.062	0.080	0.100	0.130
		U (6-/8-Fit.)	Finishing	240	0.013	0.026	0.035	0.050	0.059	0.080	0.100	0.120
<b>Free-cutting steels, unalloyed case hardened steels, nitriding steels</b> 1.0727 46 S20, 1.0728 60 S20, 1.0757 46SPb20 1.0601 C60, 1.1221 C60E 1.7043 38Cr4 1.5752 15NiCr13, 1.7131 16MnCr5, 1.7264 20CrMo5 1.8504 34CrAl6 1.8519 31CrMoV9, 1.8550 34CrAlNi7	850- 1,200 N/mm <sup>2</sup>	U (3-Fit.)	Slotting	105	0.012	0.024	0.041	0.045	0.054	0.070	0.090	0.110
		U (3-Fit.)	Roughing	130	0.014	0.028	0.037	0.052	0.062	0.080	0.100	0.130
		U (6-/8-Fit.)	Finishing	210	0.013	0.026	0.035	0.050	0.059	0.080	0.100	0.120
<b>Alloyed heat-treatable, tool and high speed steels</b> 1.5131 50MnSi4, 1.7003 38Cr2, 1.7030 28Cr4 1.5710 36NiCr6, 1.7035 41Cr4, 1.7225 42CrMo4 1.2080 X210Cr12, 1.2083 X42Cr13, 1.2419 105WCr6, 1.2379 X155CrVMo12-1 1.3243 S 6-5-2-5, 1.3343 S 6-5-2, 1.3344 S 6-5-3 Spring steel = 1.5026 55Si7, 1.7176 55Cr3, 1.8159 51CrV4	850- 1,400 N/mm <sup>2</sup>	U (3-Fit.)	Slotting	90	0.011	0.023	0.030	0.042	0.050	0.070	0.080	0.110
		U (3-Fit.)	Roughing	110	0.013	0.026	0.035	0.048	0.058	0.080	0.100	0.120
		U (6-/8-Fit.)	Finishing	180	0.013	0.025	0.033	0.046	0.055	0.070	0.090	0.120
<b>Hardened steel</b> Tool steel, heat-treatable steel, spring steel, high-speed steel, case hardened steel, etc. Z.B.: 1.2344 X40CrMoV5-1; 1.2767 X45NiCrMo4; 1.2379 X155CrVMo12-1; 1.2080 X210Cr12 1.3343 S 6-5-2	up to 54 HRC	U (3-Fit.)	Slotting	50	0.010	0.019	0.026	0.035	0.042	0.060	0.070	0.090
		H (6-/8-Fit.)*	Roughing	100	0.024	0.048	0.064	0.088	0.105	0.140	0.180	0.220
	54-60 HRC	H (6-/8-Fit.)	Finishing	110	0.010	0.019	0.026	0.035	0.042	0.060	0.070	0.090
			Finishing	70	0.019	0.038	0.050	0.070	0.084	0.110	0.140	0.180
<b>Stainless steel</b> 1.4104 X14CrMoS17, 1.4105 X6CrMoS17, 1.4305 X10CrNiS18-9 USA = 303, 410, 420F, 430, 430F	up to 750 N/mm <sup>2</sup>	U (3-Fit.)	Slotting	80	0.011	0.023	0.030	0.042	0.050	0.070	0.080	0.110
		U (3-Fit.)	Roughing	100	0.013	0.026	0.035	0.048	0.058	0.080	0.100	0.120
		U (6-/8-Fit.)	Finishing	160	0.013	0.025	0.033	0.046	0.055	0.070	0.090	0.120
<b>Stainless steel</b> 1.4301X5CrNi18-10, 1.4303 X5CrNi18-12 1.4310 XCrNi18-8 USA = 304, 304L, 420	750-850 N/mm <sup>2</sup>	U (3-Fit.)	Slotting	55	0.011	0.021	0.028	0.038	0.046	0.060	0.080	0.100
		U (3-Fit.)	Roughing	70	0.012	0.024	0.032	0.044	0.052	0.070	0.090	0.110
		U (6-/8-Fit.)	Finishing	110	0.012	0.023	0.031	0.042	0.050	0.070	0.080	0.100
<b>Stainless steel</b> 1.4438 X2CrNiMo18-15-4, 1.4404 X2CrNiMo17-12-2, 1.4571 X6CrNiTi18-10 USA = 310, 316, 316B, 316L, 317	above 850 N/mm <sup>2</sup>	U (3-Fit.)	Slotting	40	0.010	0.020	0.026	0.035	0.042	0.050	0.070	0.090
		U (3-Fit.)	Roughing	50	0.012	0.024	0.032	0.042	0.050	0.070	0.080	0.110
		U (6-/8-Fit.)	Finishing	80	0.010	0.020	0.026	0.035	0.042	0.060	0.070	0.090
<b>Special alloys (nickel based "Ni")</b> Nimonic, Inconel, Monel, Hastelloy	up to 1,300 N/mm <sup>2</sup>	U (3-Fit.)	Slotting	40	0.010	0.020	0.026	0.038	0.046	0.060	0.080	0.100
		U (3-Fit.)	Roughing	50	0.012	0.024	0.032	0.046	0.055	0.070	0.090	0.110
		U (6-/8-Fit.)	Finishing	80	0.011	0.022	0.029	0.042	0.050	0.070	0.080	0.100
<b>Titanium alloys ("Ti")</b> 3.7024 Ti99.5, 3.7114 TiAl5Sn2.5, 3.7124 TiCu2 3.7154 TiAl6Zr5, 3.7164 TiAl6V4, 3.7184 TiAl4Mo4Sn2.5	up to 1,300 N/mm <sup>2</sup>	U (3-Fit.)	Slotting	20	0.008	0.015	0.020	0.030	0.036	0.050	0.060	0.080
		U (3-Fit.)	Roughing	30	0.009	0.018	0.024	0.036	0.043	0.060	0.070	0.090
		U (6-/8-Fit.)	Finishing	40	0.008	0.015	0.020	0.030	0.036	0.050	0.060	0.080
<b>Cast iron, grey cast iron, spheroidal graphite and malleable cast iron</b> 0.6010 EN-GL100 (GG10), 0.6020 EN-GJL-200 (GG20), 0.7050 EN-GJS-500-7 (GGG50), 0.8535 EN-GJMW-350-4 (GTW35)	up to 240 HB 30	U (3-Fit.)	Slotting	105	0.012	0.024	0.032	0.045	0.054	0.070	0.090	0.110
		U (3-Fit.)	Roughing	130	0.014	0.028	0.037	0.052	0.062	0.080	0.100	0.130
		U (6-/8-Fit.)	Finishing	210	0.013	0.026	0.035	0.050	0.059	0.080	0.100	0.120
<b>Cast iron, grey cast iron, spheroidal graphite and malleable cast iron</b> 0.6025 EN-GL250 (GG25), 0.6035 EN-GJL-350 (GG35), 0.7070 EN-GJS-700-2 (GGG70), 0.8170 EN-GJMB-700-2 (GTS70)	above 240 HB 30	U (3-Fit.)	Slotting	90	0.011	0.023	0.030	0.042	0.050	0.070	0.080	0.110
		U (3-Fit.)	Roughing	110	0.013	0.026	0.035	0.048	0.058	0.080	0.100	0.120
		U (6-/8-Fit.)	Finishing	180	0.013	0.025	0.033	0.046	0.055	0.070	0.090	0.120
<b>Aluminum, Al-wrought alloys, Al-alloys</b> 3.0255 Al99.5, 3.2315 AlMgSi1, 3.3515 AlMg1 3.0615 AlMgSiPb, 3.1325 AlCuMg1, 3.3245 AlMg3Si, 3.4365 AlZnMgCu1.5	up to 3% Si	A (3-Fit.)	Slotting	300	0.015	0.030	0.040	0.055	0.066	0.090	0.110	0.140
		A (3-Fit.)	Roughing	400	0.017	0.035	0.046	0.063	0.076	0.100	0.130	0.160
		A (3-Fit.)	Finishing	600	0.017	0.033	0.044	0.061	0.073	0.100	0.120	0.150
<b>Aluminum-cast alloys</b> 3.2131 G-AlSi5Cu1, 3.2153 G-AlSi7Cu3, 3.2573 G-AlSi9 3.2581 G-AlSi12, 3.2583 G-AlSi12Cu, - G-AlSi12CuNiMg	above 3% Si	A (3-Fit.)	Slotting	180	0.014	0.027	0.036	0.050	0.060	0.080	0.100	0.130
		A (3-Fit.)	Roughing	300	0.016	0.031	0.041	0.058	0.069	0.090	0.120	0.140
		U (6-/8-Fit.)	Finishing	360	0.015	0.030	0.040	0.055	0.066	0.090	0.110	0.140
<b>Magnesium-alloys</b> MgMn2, G-MgAl8Zn1, G-MgAl6Zn3	-	A (3-Fit.)	Slotting	150	0.013	0.025	0.034	0.045	0.054	0.070	0.090	0.110
		A (3-Fit.)	Roughing	180	0.014	0.029	0.039	0.052	0.062	0.080	0.100	0.130
		A (3-Fit.)	Finishing	300	0.014	0.028	0.037	0.050	0.059	0.080	0.100	0.120
<b>Non-ferrous metals (copper, short- or long-chipping brass or bronze)</b> 2.0070 SE-Cu, 2.1020 CuSn6, 2.1096 G-CuSn5ZnPb 2.0380 CuZn39Pb2, 2.0401 CuZn39Pb3, 2.0410 CuZn43Pb2 2.0250 CuZn20, 2.0280 CuZn33, 2.0332 CuZn37Pb0.5 2.1090 CuSn7ZnPb, 2.1170 CuPb5Sn5, 2.1176 CuPb10Sn 2.0916 CuAl5, 2.0960 CuAl9Mn, 2.1050 CuSn10	up to 850 N/mm <sup>2</sup>	A (3-Fit.)	Slotting	200	0.014	0.027	0.036	0.050	0.060	0.080	0.100	0.130
		A (3-Fit.)	Roughing	230	0.016	0.031	0.041	0.058	0.069	0.090	0.120	0.140
		U (6-/8-Fit.)	Finishing	400	0.015	0.030	0.040	0.055	0.066	0.090	0.110	0.140

\* trochoid milling strategy  
All recommendations are valid for coated tools. For bright milling cutters please vc - 40% and fz -25%



Application	$v_c$ factor	$f$ factor	Feed width (ae)	Feed depth (ap)
Slotting	1	1 (0.7 for $a_p = 2xd$ )	1xd	0.5 up to 1xd
Roughing	1	1 (0.7 for $a_p = 2xd$ )	0.4 up to 0.9xd	0.5 up to 1xd
Finishing	1	1	0.01 up to 0.1xd	1 up to 2xd
HPC-roughing	1.3	1.5	0.15 up to 0.4xd	1 up to 2xd
HSC-roughing	1.5	2	0.05 up to 0.15xd	1 up to 2xd

Material	Hardness	Recommended GS 100 type	Type of application	cut Vc	fz (mm/z) with nom. Ø							
					3	6	8	10	12	16	20	25
<b>Structural + free-cutting steels, unalloyed heat-treatable + case hardened steels</b> 1.0035 S185, 1.0486 P275N, 1.0345 P235GH, 1.0050, 1.0070, 1.8937 1.0718 11SMnPb30, 1.0736 11SMn37 1.0402 C22, 1.1178 C30E 1.0503 C45, 1.1191 C30E 1.0301 C10, 1.1121 C10E 1.1750 C75W, 1.2076 102Cr6, 1.2307 29CrMoV9	up to 850 N/mm <sup>2</sup>	U	Slotting	120	0.008	0.017	0.022	0.030	0.036	0.050	0.060	0.080
		U	Roughing	140	0.010	0.019	0.026	0.035	0.041	0.060	0.070	0.090
<b>Free-cutting steels, unalloyed case hardened steels, nitriding steels</b> 1.0727 46 S20, 1.0728 60 S20, 1.0757 46SPb20 1.0601 C60, 1.1221 C60E 1.7043 38Cr4 1.5752 15NiCr13, 1.7131 16MnCr5, 1.7264 20CrMo5 1.8504 34CrAl6 1.8519 31CrMoV9, 1.8550 34CrAlNi7	850-1,200 N/mm <sup>2</sup>	U	Slotting	100	0.008	0.017	0.022	0.030	0.036	0.050	0.060	0.080
		U	Roughing	120	0.010	0.019	0.026	0.035	0.041	0.060	0.070	0.090
<b>Alloyed heat-treatable, tool and high speed steels</b> 1.5131 50MnSi4, 1.7003 38Cr2, 1.7030 28Cr4 1.5710 36NiCr6, 1.7035 41Cr4, 1.7225 42CrMo4 1.2080 X210Cr12, 1.2083 X42Cr13, 1.2419 105WCr6, 1.2379 X155CrVMo12-1 1.3243 S 6-5-2-5, 1.3343 S 6-5-2, 1.3344 S 6-5-3 Spring steel = 1.5026 55Si7, 1.7176 55Cr3, 1.8159 51CrV4	850-1,400 N/mm <sup>2</sup>	U	Slotting	90	0.008	0.015	0.020	0.028	0.034	0.040	0.060	0.070
		H	Roughing	110	0.008	0.017	0.023	0.032	0.039	0.050	0.060	0.080
<b>Hardened steel</b> Tool steel, heat-treatable steel, spring steel, high-speed steel, case hardened steel, etc. Z.B.: 1.2344 X40CrMoV5-1; 1.2767 X45NiCrMo4; 1.2379 X155CrVMo12-1; 1.2080 X210Cr12 1.3343 S 6-5-2	up to 54 HRC	H	Slotting	50	0.005	0.011	0.014	0.020	0.024	0.030	0.040	0.050
		H	Roughing	70	0.007	0.014	0.019	0.026	0.031	0.040	0.050	0.070
<b>Stainless steel</b> 1.4104 X14CrMoS17, 1.4105 X6CrMoS17, 1.4305 X10CrNiS18-9 USA = 303, 410, 420F, 430, 430F	up to 750 N/mm <sup>2</sup>	U	Slotting	80	0.008	0.015	0.020	0.028	0.034	0.040	0.060	0.070
		U	Roughing	100	0.009	0.017	0.023	0.032	0.039	0.050	0.060	0.080
<b>Stainless steel</b> 1.4301X5CrNi18-10, 1.4303 X5CrNi18-12 1.4310 XCrNi18-8 USA = 304, 304L, 420	750-850 N/mm <sup>2</sup>	U	Slotting	55	0.007	0.013	0.018	0.025	0.030	0.040	0.050	0.060
		U	Roughing	70	0.008	0.015	0.020	0.029	0.035	0.050	0.060	0.070
<b>Stainless steel</b> 1.4438 X2CrNiMo18-15-4, 1.4404 X2CrNiMo17-12-2, 1.4571 X6CrNiTi18-10 USA = 310, 316, 316B, 316L, 317	above 850 N/mm <sup>2</sup>	U	Slotting	50	0.006	0.012	0.016	0.022	0.026	0.040	0.040	0.060
		U	Roughing	70	0.007	0.014	0.019	0.026	0.032	0.040	0.050	0.070
<b>Special alloys (nickel based "Ni")</b> Nimonic, Inconel, Monel, Hastelloy	up to 1,300 N/mm <sup>2</sup>	U	Slotting	45	0.006	0.012	0.016	0.022	0.026	0.040	0.040	0.060
		U	Roughing	60	0.007	0.014	0.019	0.026	0.032	0.040	0.050	0.070
<b>Titanium alloys ("Ti")</b> 3.7024 Ti99.5, 3.7114 TiAl5Sn2.5, 3.7124 TiCu2 3.7154 TiAl6Zr5, 3.7164 TiAl6V4, 3.7184 TiAl4Mo4Sn2.5	up to 1,300 N/mm <sup>2</sup>	U	Slotting	20	0.005	0.011	0.014	0.020	0.024	0.030	0.040	0.050
		U	Roughing	30	0.006	0.013	0.017	0.024	0.029	0.040	0.050	0.060
<b>Cast iron, grey cast iron, spheroidal graphite and malleable cast iron</b> 0.6010 EN-GL100 (GG10), 0.6020 EN-GJL-200 (GG20), 0.7050 EN-GJS-500-7 (GGG50), 0.8535 EN-GJMW-350-4 (GTW35)	up to 240 HB 30	U	Slotting	100	0.008	0.017	0.022	0.030	0.036	0.050	0.060	0.080
		U	Roughing	120	0.010	0.019	0.026	0.035	0.041	0.060	0.070	0.090
<b>Cast iron, grey cast iron, spheroidal graphite and malleable cast iron</b> 0.6025 EN-GL250 (GG25), 0.6035 EN-GJL-350 (GG35), 0.7070 EN-GJS-700-2 (GGG70), 0.8170 EN-GJMB-700-2 (GTS70)	above 240 HB 30	H	Slotting	90	0.008	0.015	0.020	0.028	0.034	0.040	0.060	0.070
		H	Roughing	110	0.009	0.017	0.023	0.032	0.039	0.050	0.060	0.080
<b>Aluminum, Al-wrought alloys, Al-alloys</b> 3.0255 Al99.5, 3.2315 AlMgSi1, 3.3515 AlMg1 3.0615 AlMgSiPb, 3.1325 AlCuMg1, 3.3245 AlMg3Si, 3.4365 AlZnMgCu1.5	up to 3% Si	A	Slotting	350	0.010	0.019	0.026	0.035	0.042	0.060	0.070	0.090
		A	Roughing	410	0.011	0.022	0.029	0.040	0.048	0.060	0.080	0.100
<b>Aluminum-cast alloys</b> 3.2131 G-AlSi5Cu1, 3.2153 G-AlSi7Cu3, 3.2573 G-AlSi9 3.2581 G-AlSi12, 3.2583 G-AlSi12Cu, - G-AlSi12CuNiMg	above 3% Si	A	Slotting	180	0.009	0.018	0.024	0.032	0.038	0.050	0.060	0.080
		A	Roughing	210	0.010	0.021	0.028	0.037	0.044	0.060	0.070	0.090
<b>Magnesium-alloys</b> MgMn2, G-MgAl8Zn1, G-MgAl6Zn3	-	A	Slotting	120	0.009	0.018	0.024	0.032	0.038	0.050	0.060	0.080
		A	Roughing	140	0.010	0.021	0.028	0.037	0.044	0.060	0.070	0.090
<b>Non-ferrous metals (copper, short- or long-chipping brass or bronze)</b> 2.0070 SE-Cu, 2.1020 CuSn6, 2.1096 G-CuSn5ZnPb 2.0380 CuZn39Pb2, 2.0401 CuZn39Pb3, 2.0410 CuZn43Pb2 2.0250 CuZn20, 2.0280 CuZn33, 2.0332 CuZn37Pb0.5 2.1090 CuSn7ZnPb, 2.1170 CuPb5Sn5, 2.1176 CuPb10Sn 2.0916 CuAl5, 2.0960 CuAl9Mn, 2.1050 CuSn10	up to 850 N/mm <sup>2</sup>	A	Slotting	180	0.009	0.018	0.024	0.032	0.038	0.050	0.060	0.080
		A	Roughing	210	0.010	0.021	0.028	0.037	0.044	0.060	0.070	0.090

All recommendations are valid for coated tools. For bright milling cutters please vc - 40% and fz -25%



Application	v <sub>c</sub> factor	f <sub>z</sub> factor	Feed width (ae)	Feed depth (ap)
Slotting	1	1 (0.7 for a <sub>e</sub> = 2xd)	1xd	0.5 up to 1xd
Roughing	1	1 (0.7 for a <sub>e</sub> = 2xd)	0.4 up to 0.9xd	0.5 up to 1xd
Finishing	1	1	0.01 up to 0.1xd	1 up to 2xd
HPC-roughing	1.3	1.5	0.15 up to 0.4xd	1 up to 2xd
HSC-roughing	1.5	2	0.05 up to 0.15xd	1 up to 2xd

Material	Hardness	Recommended RS 100 type	Type of application	cut Vc	fz (mm/z) with nom. Ø							
					3	6	8	10	12	16	20	25
<b>Structural + free-cutting steels, unalloyed heat-treatable + case hardened steels</b> 1.0035 S185, 1.0486 P275N, 1.0345 P235GH, 1.0050, 1.0070, 1.8937 1.0718 11SMnPb30, 1.0736 11SMn37 1.0402 C22, 1.1178 C30E 1.0503 C45, 1.1191 C30E 1.0301 C10, 1.1121 C10E 1.1750 C75W, 1.2076 102Cr6, 1.2307 29CrMoV9	up to 850 N/mm <sup>2</sup>	U	Slotting	140	0.011	0.023	0.027	0.036	0.041	0.054	0.063	0.090
		F	Roughing	160	0.014	0.023	0.032	0.041	0.045	0.059	0.072	0.108
			Finishing									
<b>Free-cutting steels, unalloyed case hardened steels, nitriding steels</b> 1.0727 46 S20, 1.0728 60 S20, 1.0757 46SPb20 1.0601 C60, 1.1221 C60E 1.7043 38Cr4 1.5752 15NiCr13, 1.7131 16MnCr5, 1.7264 20CrMo5 1.8504 34CrAl6 1.8519 31CrMoV9, 1.8550 34CrAlNi7	850-1,200 N/mm <sup>2</sup>	U	Slotting	130	0.011	0.023	0.027	0.036	0.041	0.054	0.063	0.090
		F	Roughing	150	0.014	0.023	0.032	0.041	0.045	0.059	0.072	0.108
			Finishing									
<b>Alloyed heat-treatable, tool and high speed steels</b> 1.5131 50MnSi4, 1.7003 38Cr2, 1.7030 28Cr4 1.5710 36NiCr6, 1.7035 41Cr4, 1.7225 42CrMo4 1.2080 X210Cr12, 1.2083 X42Cr13, 1.2419 105WCr6, 1.2379 X155CrVmo12-1 1.3243 S 6-5-2-5, 1.3343 S 6-5-2, 1.3344 S 6-5-3 Spring steel = 1.5026 55Si7, 1.7176 55Cr3, 1.8159 51CrV4	850-1,400 N/mm <sup>2</sup>	U	Slotting	110	0.009	0.014	0.023	0.027	0.032	0.041	0.054	0.063
		F	Roughing	130	0.009	0.018	0.027	0.032	0.036	0.050	0.059	0.072
			Finishing									
<b>Hardened steel</b> Tool steel, heat-treatable steel, spring steel, high-speed steel, case hardened steel, etc. Z.B.: 1.2344 X40CrMoV5-1; 1.2767 X45NiCrMo4; 1.2379 X155CrVmo12-1; 1.2080 X210Cr12 1.3343 S 6-5-2	up to 54 HRC	F*	Slotting	55	0.009	0.014	0.018	0.023	0.027	0.036	0.045	0.054
		F	Roughing	90	0.011	0.014	0.023	0.027	0.032	0.041	0.054	0.063
			Finishing									
<b>Stainless steel</b> 1.4104 X14CrMoS17, 1.4105 X6CrMoS17, 1.4305 X10CrNiS18-9 USA = 303, 410, 420F, 430, 430F	up to 750 N/mm <sup>2</sup>	U	Slotting	100	0.011	0.023	0.027	0.036	0.041	0.054	0.063	0.090
		U	Roughing	115	0.014	0.023	0.032	0.041	0.045	0.059	0.072	0.108
			Finishing									
<b>Stainless steel</b> 1.4301X5CrNi18-10, 1.4303 X5CrNi18-12 1.4310 XCrNi18-8 USA = 304, 304L, 420	750-850 N/mm <sup>2</sup>	U	Slotting	65	0.009	0.014	0.023	0.027	0.032	0.041	0.054	0.063
		U	Roughing	100	0.011	0.018	0.027	0.032	0.036	0.050	0.059	0.072
			Finishing									
<b>Stainless steel</b> 1.4438 X2CrNiMo18-15-4, 1.4404 X2CrNiMo17-12-2, 1.4571 X6CrNiTi18-10 USA = 310, 316, 316B, 316L, 317	above 850 N/mm <sup>2</sup>	U	Slotting	55	0.009	0.014	0.018	0.023	0.027	0.036	0.045	0.054
		U	Roughing	80	0.011	0.014	0.023	0.027	0.032	0.041	0.054	0.063
			Finishing									
<b>Special alloys (nickel based "Ni")</b> Nimonic, Inconel, Monel, Hastelloy	up to 1,300 N/mm <sup>2</sup>	U	Slotting	25	0.007	0.009	0.014	0.018	0.023	0.032	0.036	0.045
		F	Roughing	30	0.009	0.014	0.018	0.023	0.027	0.036	0.045	0.054
			Finishing									
<b>Titanium alloys ("Ti")</b> 3.7024 Ti99.5, 3.7114 TiAl5Sn2.5, 3.7124 TiCu2 3.7154 TiAl6Zr5, 3.7164 TiAl6V4, 3.7184 TiAl4Mo4Sn2.5	up to 1,300 N/mm <sup>2</sup>	U	Slotting	55	0.009	0.014	0.023	0.027	0.032	0.041	0.054	0.063
		F	Roughing	80	0.011	0.018	0.027	0.032	0.036	0.050	0.059	0.072
			Finishing									
<b>Cast iron, grey cast iron, spheroidal graphite and malleable cast iron</b> 0.6010 EN-GL100 (GG10), 0.6020 EN-GJL-200 (GG20), 0.7050 EN-GJS-500-7 (GGG50), 0.8535 EN-GJMW-350-4 (GTW35)	up to 240 HB 30	U	Slotting	150	0.014	0.023	0.032	0.041	0.045	0.059	0.072	0.108
		F	Roughing	160	0.014	0.027	0.036	0.045	0.054	0.063	0.081	0.117
			Finishing									
<b>Cast iron, grey cast iron, spheroidal graphite and malleable cast iron</b> 0.6025 EN-GL250 (GG25), 0.6035 EN-GJL-350 (GG35), 0.7070 EN-GJS-700-2 (GGG70), 0.8170 EN-GJMB-700-2 (GTS70)	above 240 HB 30	U	Slotting	130	0.011	0.023	0.027	0.036	0.041	0.054	0.063	0.090
		F	Roughing	150	0.014	0.023	0.032	0.041	0.045	0.059	0.072	0.108
			Finishing									
<b>Aluminum, Al-wrought alloys, Al-alloys</b> 3.0255 Al99.5, 3.2315 AlMgSi1, 3.3515 AlMg1 3.0615 AlMgSiPb, 3.1325 AlCuMg1, 3.3245 AlMg3Si, 3.4365 AlZnMgCu1.5	up to 3% Si	U	Slotting	450	0.014	0.027	0.036	0.050	0.059	0.072	0.086	0.126
		U	Roughing	540	0.016	0.032	0.041	0.054	0.063	0.081	0.090	0.135
<b>Aluminum-cast alloys</b> 3.2131 G-AlSi5Cu1, 3.2153 G-AlSi7Cu3, 3.2573 G-AlSi9 3.2581 G-AlSi12, 3.2583 G-AlSi12Cu, - G-AlSi12CuNiMg	above 3% Si	U	Slotting	200	0.014	0.023	0.032	0.041	0.045	0.059	0.072	0.108
		U	Roughing	250	0.014	0.027	0.036	0.045	0.054	0.063	0.081	0.117
<b>Magnesium-alloys</b> MgMn2, G-MgAl8Zn1, G-MgAl6Zn3	-	U	Slotting	160	0.011	0.023	0.027	0.036	0.041	0.054	0.063	0.090
		U	Roughing	200	0.014	0.027	0.036	0.045	0.054	0.063	0.081	0.117
<b>Non-ferrous metals (copper, short- or long-chipping brass or bronze)</b> 2.0070 SE-Cu, 2.1020 CuSn6, 2.1096 G-CuSn5ZnPb 2.0380 CuZn39Pb2, 2.0401 CuZn39Pb3, 2.0410 CuZn43Pb2 2.0250 CuZn20, 2.0280 CuZn33, 2.0332 CuZn37Pb0.5 2.1090 CuSn7ZnPb, 2.1170 CuPb5Sn5, 2.1176 CuPb10Sn 2.0916 CuAl5, 2.0960 CuAl9Mn, 2.1050 CuSn10	up to 850 N/mm <sup>2</sup>	U	Slotting	225	0.011	0.023	0.027	0.036	0.041	0.054	0.063	0.090
		U	Roughing	270	0.014	0.027	0.036	0.045	0.054	0.063	0.081	0.117

\* trochoid milling strategy

All recommendations are valid for coated tools. For bright milling cutters please vc - 40% and fz -25%

Tool length/reach up to 3xD Vc and fz 100%  
 Tool length/reach 3-5xD Vc and fz 80%  
 Tool length/reach > 5-10xD Vc and fz 60%



Application	Width/depth	Nom. diameter (mm)									
		2	3	4	6	8	10	12	16		
Roughing	ae (mm)	0.1	0.15	0.2	0.4	0.6	0.75	1	1.2		
	ap (mm)	0.15	0.15	0.3	0.5	0.75	1	1.5	1.5		
Finishing	ae (mm)	0.05	0.07	0.1	0.14	0.16	0.18	0.2	0.3		
	ap (mm)	0.05	0.05	0.07	0.1	0.15	0.2	0.25	0.3		

Material	Hardness	Type of End Mill	ae Max	cut Vc	fz (mm/z) with nom. Ø							
					3	6	8	10	12	16	20	25
<b>Structural + free-cutting steels, unalloyed heat-treatable + case hardened steels</b> 1.0035 S185, 1.0486 P275N, 1.0345 P235GH, 1.0050, 1.0070, 1.8937 1.0718 11SMnPb30, 1.0736 11SMn37 1.0402 C22, 1.1178 C30E 1.0503 C45, 1.1191 C30E 1.0301 C10, 1.1121 C10E 1.1750 C75W, 1.2076 102Cr6, 1.2307 29CrMoV9	up to 28 HRC	GF 500 B	0.1 x D	240	0.030	0.045	0.060	0.090	0.120	0.150	0.180	0.240
		GF 500 B	0.03 x D	340	0.021	0.032	0.042	0.063	0.084	0.110	0.130	0.170
		GF 500 B	0.01 x d	390	0.018	0.027	0.036	0.054	0.072	0.090	0.110	0.140
<b>Free-cutting steels, unalloyed case hardened steels, nitriding steels</b> 1.0727 46 S20, 1.0728 60 S20, 1.0757 46SPb20 1.0601 C60, 1.1221 C60E 1.7043 38Cr4 1.5752 15NiCr13, 1.7131 16MnCr5, 1.7264 20CrMo5 1.8504 34CrAl6 1.8519 31CrMoV9, 1.8550 34CrAlNi7	28 to 38 HRC	GF 500 B	0.1 x D	220	0.030	0.045	0.060	0.090	0.120	0.150	0.180	0.240
		GF 500 B	0.03 x D	310	0.021	0.032	0.042	0.063	0.084	0.110	0.130	0.170
		GF 500 B	0.01 x d	350	0.020	0.030	0.039	0.059	0.078	0.100	0.120	0.160
<b>Alloyed heat-treatable, tool and high speed steels</b> 1.5131 50MnSi4, 1.7003 38Cr2, 1.7030 28Cr4 1.5710 36NiCr6, 1.7035 41Cr4, 1.7225 42CrMo4 1.2080 X210Cr12, 1.2083 X42Cr13, 1.2419 105WCr6, 1.2379 X155CrVMo12-1 1.3243 S 6-5-2-5, 1.3343 S 6-5-2, 1.3344 S 6-5-3 Spring steel = 1.5026 55Si7, 1.7176 55Cr3, 1.8159 51CrV4	28 to 44 HRC	GF 500 B	0.1 x D	200	0.024	0.036	0.048	0.072	0.096	0.120	0.140	0.190
		GF 500 B	0.03 x D	310	0.017	0.026	0.034	0.050	0.067	0.080	0.100	0.130
		GF 500 B	0.01 x d	320	0.016	0.024	0.031	0.047	0.062	0.080	0.090	0.120
<b>Hardened steel</b> Tool steel, heat-treatable steel, spring steel, high-speed steel, case hardened steel, etc. Z.B.: 1.2344 X40CrMoV5-1; 1.2767 X45NiCrMo4; 1.2379 X155CrVMo12-1; 1.2080 X210Cr12 1.3343 S 6-5-2	up to 54 HRC	GF 500 B	0.1 x D	130	0.024	0.036	0.048	0.072	0.096	0.120	0.140	0.190
		GF 500 B	0.02 x D	200	0.017	0.026	0.034	0.050	0.067	0.080	0.100	0.130
	54-60 HRC	GF 500 B	0.01 x d	220	0.014	0.022	0.029	0.043	0.058	0.070	0.090	0.120
		GF 300 B	0.02 x D	150	0.014	0.021	0.028	0.042	0.056	0.070	0.080	0.110
<b>Stainless steel</b> 1.4104 X14CrMoS17, 1.4105 X6CrMoS17, 1.4305 X10CrNiS18-9 USA = 303, 410, 420F, 430, 430F	up to 28 HRC	GF 500 B	0.1 x D	160	0.026	0.039	0.052	0.078	0.104	0.130	0.160	0.210
		GF 500 B	0.03 x D	230	0.018	0.027	0.036	0.055	0.073	0.090	0.110	0.150
		GF 500 B	0.01 x d	260	0.016	0.024	0.031	0.047	0.062	0.080	0.090	0.120
<b>Stainless steel</b> 1.4301X5CrNi18-10, 1.4303 X5CrNi18-12 1.4310 XCrNi18-8 USA = 304, 304L, 420	up to 28 HRC	GF 500 B	0.1 x D	120	0.024	0.036	0.048	0.072	0.096	0.120	0.140	0.190
		GF 500 B	0.03 x D	170	0.017	0.026	0.034	0.050	0.067	0.080	0.100	0.130
		GF 500 B	0.01 x d	190	0.014	0.022	0.029	0.043	0.058	0.070	0.090	0.120
<b>Stainless steel</b> 1.4438 X2CrNiMo18-15-4, 1.4404 X2CrNiMo17-12-2, 1.4571 X6CrNiTi18-10 USA = 310, 316, 316B, 316L, 317	over 28 HRC	GF 500 B	0.1 x D	80	0.020	0.030	0.040	0.060	0.080	0.100	0.120	0.160
		GF 500 B	0.02 x D	120	0.014	0.021	0.028	0.042	0.056	0.070	0.080	0.110
		GF 500 B	0.01 x d	140	0.012	0.018	0.024	0.036	0.048	0.060	0.070	0.100
<b>Special alloys (nickel based "Ni")</b> Nimonic, Inconel, Monel, Hastelloy	up to 42 HRC	GF 500 B	0.1 x D	45	0.020	0.030	0.040	0.060	0.080	0.100	0.120	0.160
		GF 500 B	0.02 x D	60	0.014	0.021	0.028	0.042	0.056	0.070	0.080	0.110
		GF 500 B	0.01 x d	80	0.012	0.018	0.024	0.036	0.048	0.060	0.070	0.100
<b>Titanium alloys ("Ti")</b> 3.7024 Ti99.5, 3.7114 TiAl5Sn2.5, 3.7124 TiCu2 3.7154 TiAl6Zr5, 3.7164 TiAl6V4, 3.7184 TiAl4Mo4Sn2.5	up to 42 HRC	GF 500 B	0.1 x D	100	0.024	0.036	0.048	0.072	0.096	0.120	0.140	0.190
		GF 500 B	0.02 x D	150	0.017	0.026	0.034	0.050	0.067	0.080	0.100	0.130
		GF 500 B	0.01 x d	170	0.014	0.022	0.029	0.043	0.058	0.070	0.090	0.120
<b>Cast iron, grey cast iron, spheroidal graphite and malleable cast iron</b> 0.6010 EN-GL100 (GG10), 0.6020 EN-GJL-200 (GG20), 0.7050 EN-GJS-500-7 (GGG50), 0.8535 EN-GJMw-350-4 (GTW35)	up to 240 HB 30	GF 500 B	0.1 x D	220	0.030	0.045	0.060	0.090	0.120	0.150	0.180	0.240
		GF 500 B	0.03 x D	310	0.021	0.032	0.042	0.063	0.084	0.110	0.130	0.170
		GF 500 B	0.01 x d	360	0.018	0.027	0.036	0.054	0.072	0.090	0.110	0.140
<b>Cast iron, grey cast iron, spheroidal graphite and malleable cast iron</b> 0.6025 EN-GL250 (GG25), 0.6035 EN-GJL-350 (GG35), 0.7070 EN-GJS-700-2 (GGG70), 0.8170 EN-GJMB-700-2 (GTS70)	over 240 HB 30	GF 300 B	0.1 x D	180	0.026	0.039	0.052	0.078	0.104	0.130	0.160	0.210
		GF 300 B	0.02 x D	270	0.018	0.027	0.036	0.055	0.073	0.090	0.110	0.150
		GF 300 B	0.01 x d	300	0.016	0.024	0.031	0.047	0.062	0.080	0.090	0.120
<b>Aluminum, Al-wrought alloys, Al-alloys</b> 3.0255 Al99.5, 3.2315 AlMgSi1, 3.3515 AlMg1 3.0615 AlMgSiPb, 3.1325 AlCuMg1, 3.3245 AlMg3Si, 3.4365 AlZnMgCu1.5	up to 7% Si	GF 500 B	0.1 x D	600	0.032	0.048	0.064	0.096	0.128	0.160	0.190	0.260
		GF 500 B	0.03 x D	800	0.022	0.034	0.045	0.067	0.090	0.110	0.130	0.180
		GF 500 B	0.01 x d	900	0.019	0.029	0.038	0.058	0.077	0.100	0.120	0.150
<b>Aluminum-cast alloys</b> 3.2131 G-AlSi5Cu1, 3.2153 G-AlSi7Cu3, 3.2573 G-AlSi9 3.2581 G-AlSi12, 3.2583 G-AlSi12Cu, - G-AlSi12CuNiMg	over 7% Si	GF 500 B	0.1 x D	300	0.030	0.045	0.060	0.090	0.120	0.150	0.180	0.240
		GF 500 B	0.03 x D	400	0.021	0.032	0.042	0.063	0.084	0.110	0.130	0.170
		GF 500 B	0.01 x d	500	0.018	0.027	0.036	0.054	0.072	0.090	0.110	0.140
<b>Magnesium-alloys</b> MgMn2, G-MgAl8Zn1, G-MgAl6Zn3	—	GF 500 B	0.1 x D	180	0.026	0.039	0.052	0.078	0.104	0.130	0.160	0.210
		GF 500 B	0.03 x D	260	0.018	0.027	0.036	0.055	0.073	0.090	0.110	0.150
		GF 500 B	0.01 x d	290	0.016	0.024	0.031	0.047	0.062	0.080	0.090	0.120
<b>Non-ferrous metals (copper, short- or long-chipping brass or bronze)</b> 2.0070 SE-Cu, 2.1020 CuSn6, 2.1096 G-CuSn5ZnPb 2.0380 CuZn39Pb2, 2.0401 CuZn39Pb3, 2.0410 CuZn43Pb2 2.0250 CuZn20, 2.0280 CuZn33, 2.0332 CuZn37Pb0.5 2.1090 CuSn7ZnPb, 2.1170 CuPb5Sn5, 2.1176 CuPb10Sn 2.0916 CuAl5, 2.0960 CuAl9Mn, 2.1050 CuSn10	up to 850 N/mm²	GF 500 B	0.1 x D	250	0.030	0.045	0.060	0.090	0.120	0.150	0.180	0.240
		GF 500 B	0.03 x D	350	0.021	0.032	0.042	0.063	0.084	0.110	0.130	0.170
		GF 500 B	0.01 x d	400	0.018	0.027	0.036	0.054	0.072	0.090	0.110	0.140

All recommendations are valid for coated tools. For bright milling cutters please vc - 40% and fz -25%

# GF 500 T and GF 300 T ("Torus" Nose / Corner Radius)

# METRIC

Tool length/reach up to 3xD Vc and fz 100%  
 Tool length/reach 3-5xD Vc and fz 80%  
 Tool length/reach > 5-10xD Vc and fz 60%



		Nom. diameter (mm)								
Application	Width/depth		2	3	4	6	8	10	12	16
Roughing	ae (mm)		0.15	0.2	0.3	0.4	0.6	0.75	1	1.5
	ap (mm)		1	1.5	2	3	4	5	6	8
Finishing	ae (mm)		0.08	0.11	0.13	0.15	0.2	0.3	0.4	0.5
	ap (mm)		0.2	0.3	0.4	0.7	1	1.5	2	3

Material	Hardness	Type of End Mill	ae Max	cut Vc	fz (mm/z) with nom. Ø							
					3	6	8	10	12	16	20	25
<b>Structural + free-cutting steels, unalloyed heat-treatable + case hardened steels</b> 1.0035 S185, 1.0486 P275N, 1.0345 P235GH, 1.0050, 1.0070, 1.8937 1.0718 11SMnPb30, 1.0736 11SMn37 1.0402 C22, 1.1178 C30E 1.0503 C45, 1.1191 C30E 1.0301 C10, 1.1121 C10E 1.1750 C75W, 1.2076 102Cr6, 1.2307 29CrMoV9	up to 28 HRC	GF500	0.40 x D	240	0.030	0.045	0.060	0.090	0.120	0.150	0.180	0.240
		GF500	0.25 x D	340	0.021	0.032	0.042	0.063	0.084	0.110	0.130	0.170
		GF500	0.15 x D	360	0.021	0.032	0.042	0.063	0.084	0.110	0.130	0.170
<b>Free-cutting steels, unalloyed case hardened steels, nitriding steels</b> 1.0727 46 S20, 1.0728 60 S20, 1.0757 46SPb20 1.0601 C60, 1.1221 C60E 1.7043 38Cr4 1.5752 15NiCr13, 1.7131 16MnCr5, 1.7264 20CrMo5 1.8504 34CrAl6 1.8519 31CrMoV9, 1.8550 34CrAlNi7	28 to 38 HRC	GF500	0.40 x D	220	0.030	0.045	0.060	0.090	0.120	0.150	0.180	0.240
		GF500	0.25 x D	310	0.021	0.032	0.042	0.063	0.084	0.110	0.130	0.170
		GF500	0.15 x D	330	0.021	0.032	0.042	0.063	0.084	0.110	0.130	0.170
<b>Alloyed heat-treatable, tool and high speed steels</b> 1.5131 50MnSi4, 1.7003 38Cr2, 1.7030 28Cr4 1.5710 36NiCr6, 1.7035 41Cr4, 1.7225 42CrMo4 1.2080 X210Cr12, 1.2083 X42Cr13, 1.2419 105WCr6, 1.2379 X155CrVMo12-1 1.3243 S 6-5-2-5, 1.3343 S 6-5-2, 1.3344 S 6-5-3 Spring steel = 1.5026 55Si7, 1.7176 55Cr3, 1.8159 51CrV4	28 to 44 HRC	GF500	0.40 x D	200	0.024	0.036	0.048	0.072	0.096	0.120	0.140	0.190
		GF500	0.25 x D	280	0.017	0.026	0.034	0.050	0.067	0.080	0.100	0.130
		GF500	0.15 x D	300	0.017	0.026	0.034	0.050	0.067	0.080	0.100	0.130
<b>Hardened steel</b> Tool steel, heat-treatable steel, spring steel, high-speed steel, case hardened steel, etc. Z.B.: 1.2344 X40CrMoV5-1; 1.2767 X45NiCrMo4; 1.2379 X155CrVMo12-1; 1.2080 X210Cr12 1.3343 S 6-5-2	up to 54 HRC	GF500	0.30 x D	120	0.024	0.036	0.048	0.072	0.096	0.120	0.140	0.190
		GF500	0.20 x D	190	0.017	0.026	0.034	0.050	0.067	0.080	0.100	0.130
	54-60 HRC	GF500	0.15 x D	200	0.017	0.026	0.034	0.050	0.067	0.080	0.100	0.130
					0.020	0.030	0.040	0.060	0.080	0.100	0.120	0.160
		GF300	0.20 x D	150	0.014	0.021	0.028	0.042	0.056	0.070	0.080	0.110
		GF300	0.10 x D	160	0.013	0.020	0.026	0.039	0.052	0.070	0.080	0.100
<b>Stainless steel</b> 1.4104 X14CrMoS17, 1.4105 X6CrMoS17, 1.4305 X10CrNiS18-9 USA = 303, 410, 420F, 430, 430F	up to 28 HRC	GF500	0.40 x D	160	0.026	0.039	0.052	0.078	0.104	0.130	0.160	0.210
		GF500	0.25 x D	230	0.018	0.027	0.036	0.055	0.073	0.090	0.110	0.150
		GF500	0.15 x D	240	0.018	0.027	0.036	0.055	0.073	0.090	0.110	0.150
<b>Stainless steel</b> 1.4301X5CrNi18-10, 1.4303 X5CrNi18-12 1.4310 XCrNi18-8 USA = 304, 304L, 420	up to 28 HRC	GF500	0.30 x D	120	0.024	0.036	0.048	0.072	0.096	0.120	0.140	0.190
		GF500	0.25 x D	170	0.017	0.026	0.034	0.050	0.067	0.080	0.100	0.130
		GF500	0.10 x D	190	0.016	0.024	0.031	0.047	0.062	0.080	0.090	0.120
<b>Stainless steel</b> 1.4438 X2CrNiMo18-15-4, 1.4404 X2CrNiMo17-12-2, 1.4571 X6CrNiTi18-10 USA = 310, 316, 316B, 316L, 317	over 28 HRC	GF500	0.25 x D	80	0.020	0.030	0.040	0.060	0.080	0.100	0.120	0.160
		GF500	0.20 x D	120	0.014	0.021	0.028	0.042	0.056	0.070	0.080	0.110
		GF500	0.10 x D	130	0.013	0.020	0.026	0.039	0.052	0.070	0.080	0.100
<b>Special alloys (nickel based "Ni")</b> Nimonic, Inconel, Monel, Hastelloy	up to 42 HRC	GF500	0.25 x D	45	0.020	0.030	0.040	0.060	0.080	0.100	0.120	0.160
		GF500	0.20 x D	60	0.014	0.021	0.028	0.042	0.056	0.070	0.080	0.110
		GF500	0.10 x D	80	0.013	0.020	0.026	0.039	0.052	0.070	0.080	0.100
<b>Titanium alloys ("Ti")</b> 3.7024 Ti99.5, 3.7114 TiAl5Sn2.5, 3.7124 TiCu2 3.7154 TiAl6Zr5, 3.7164 TiAl6V4, 3.7184 TiAl4Mo4Sn2.5	up to 42 HRC	GF500	0.30 x D	100	0.024	0.036	0.048	0.072	0.096	0.120	0.140	0.190
		GF500	0.20 x D	150	0.017	0.026	0.034	0.050	0.067	0.080	0.100	0.130
		GF500	0.15 x D	150	0.017	0.026	0.034	0.050	0.067	0.080	0.100	0.130
<b>Cast iron, grey cast iron, spheroidal graphite and malleable cast iron</b> 0.6010 EN-GL100 (GG10), 0.6020 EN-GJL-200 (GG20), 0.7050 EN-GJS-500-7 (GGG50), 0.8535 EN-GJMW-350-4 (GTW35)	up to 240 HB 30	GF500	0.40 x D	220	0.030	0.045	0.060	0.090	0.120	0.150	0.180	0.240
		GF500	0.25 x D	310	0.021	0.032	0.042	0.063	0.084	0.110	0.130	0.170
		GF500	0.15 x D	330	0.021	0.032	0.042	0.063	0.084	0.110	0.130	0.170
<b>Cast iron, grey cast iron, spheroidal graphite and malleable cast iron</b> 0.6025 EN-GL250 (GG25), 0.6035 EN-GJL-350 (GG35), 0.7070 EN-GJS-700-2 (GGG70), 0.8170 EN-GJMB-700-2 (GTS70)	over 240 HB 30	GF300	0.40 x D	180	0.026	0.039	0.052	0.078	0.104	0.130	0.160	0.210
		GF300	0.25 x D	250	0.018	0.027	0.036	0.055	0.073	0.090	0.110	0.150
		GF300	0.15 x D	270	0.018	0.027	0.036	0.055	0.073	0.090	0.110	0.150
<b>Aluminum, Al-wrought alloys, Al-alloys</b> 3.0255 Al99.5, 3.2315 AlMgSi1, 3.3515 AlMg1 3.0615 AlMgSiPb, 3.1325 AlCuMg1, 3.3245 AlMg3Si, 3.4365 AlZnMgCu1.5	up to 7% Si	GF500	0.40 x D	600	0.032	0.048	0.064	0.096	0.128	0.160	0.190	0.260
		GF500	0.25 x D	800	0.022	0.034	0.045	0.067	0.090	0.110	0.130	0.180
		GF500	0.15 x D	900	0.022	0.034	0.045	0.067	0.090	0.110	0.130	0.180
<b>Aluminum-cast alloys</b> 3.2131 G-AlSi5Cu1, 3.2153 G-AlSi7Cu3, 3.2573 G-AlSi9 3.2581 G-AlSi12, 3.2583 G-AlSi12Cu, - G-AlSi12CuNiMg	over 7% Si	GF500	0.40 x D	300	0.030	0.045	0.060	0.090	0.120	0.150	0.180	0.240
		GF500	0.25 x D	400	0.021	0.032	0.042	0.063	0.084	0.110	0.130	0.170
		GF500	0.15 x D	500	0.021	0.032	0.042	0.063	0.084	0.110	0.130	0.170
<b>Magnesium-alloys</b> MgMn2, G-MgAl8Zn1, G-MgAl6Zn3	-	GF 500	0.40 x D	180	0.026	0.039	0.052	0.078	0.104	0.130	0.160	0.210
		GF 500	0.25 x D	260	0.018	0.027	0.036	0.055	0.073	0.090	0.110	0.150
		GF 500	0.15 x D	270	0.018	0.027	0.036	0.055	0.073	0.090	0.110	0.150
<b>Non-ferrous metals (copper, short- or long-chipping brass or bronze)</b> 2.0070 SE-Cu, 2.1020 CuSn6, 2.1096 G-CuSn5ZnPb 2.0380 CuZn39Pb2, 2.0401 CuZn39Pb3, 2.0410 CuZn43Pb2 2.0250 CuZn20, 2.0280 CuZn33, 2.0332 CuZn37Pb0.5 2.1090 CuSn7ZnPb, 2.1170 CuPb5Sn5, 2.1176 CuPb10Sn 2.0916 CuAl5, 2.0960 CuAl9Mn, 2.1050 CuSn10	up to 850 N/mm²	GF 500	0.40 x D	250	0.030	0.045	0.060	0.090	0.120	0.150	0.180	0.240
		GF 500	0.25 x D	350	0.021	0.032	0.042	0.063	0.084	0.110	0.130	0.170
		GF 500	0.15 x D	300	0.021	0.032	0.042	0.063	0.084	0.110	0.130	0.170

All recommendations are valid for coated tools. For bright milling cutters please vc - 40% and fz - 25%



Application	v <sub>c</sub> factor	f <sub>c</sub> factor	Feed width (ae)	Feed depth (ap)
Slotting	1	1 (0.7 for a <sub>e</sub> = 2xd)	1xd	0.5 up to 1xd
Roughing	1	1 (0.7 for a <sub>e</sub> = 2xd)	0.4 up to 0.9xd	0.5 up to 1xd
Finishing	1	1	0.01 up to 0.1xd	1 up to 2xd
HPC-roughing	1.3	1.5	0.15 up to 0.4xd	1 up to 2xd
HSC-roughing	1.5	2	0.05 up to 0.15xd	1 up to 2xd

Material	Hardness	Recommended type	Type of application	cut Vc	fz (mm/z) with nom. Ø							
					3	6	8	10	12	16	20	25
<b>Structural + free-cutting steels, unalloyed heat-treatable + case hardened steels</b> 1.0035 S185, 1.0486 P275N, 1.0345 P235GH, 1.0050, 1.0070, 1.8937 1.0718 11SMnPb30, 1.0736 11SMn37 1.0402 C22, 1.1178 C30E 1.0503 C45, 1.1191 C30E 1.0301 C10, 1.1121 C10E 1.1750 C75W, 1.2076 102Cr6, 1.2307 29CrMoV9	up to 850 N/mm <sup>2</sup>	2/3 Flute	Slotting	120	0.012	0.024	0.032	0.042	0.050	0.070	0.080	0.110
		3/4 Flute	Roughing	140	0.014	0.028	0.037	0.048	0.058	0.080	0.100	0.120
		4 Flute	Finishing	240	0.013	0.026	0.035	0.046	0.055	0.070	0.090	0.120
<b>Free-cutting steels, unalloyed case hardened steels, nitriding steels</b> 1.0727 46 S20, 1.0728 60 S20, 1.0757 46SPb20 1.0601 C60, 1.1221 C60E 1.7043 38Cr4 1.5752 15NiCr13, 1.7131 16MnCr5, 1.7264 20CrMo5 1.8504 34CrAl6 1.8519 31CrMoV9, 1.8550 34CrAlNi7	850-1.200 N/mm <sup>2</sup>	2/3 Flute	Slotting	110	0.012	0.024	0.032	0.042	0.050	0.070	0.080	0.110
		3/4 Flute	Roughing	130	0.014	0.028	0.037	0.048	0.058	0.080	0.100	0.120
		4 Flute	Finishing	220	0.013	0.026	0.035	0.046	0.055	0.070	0.090	0.120
<b>Alloyed heat-treatable, tool and high speed steels</b> 1.5131 50MnSi4, 1.7003 38Cr2, 1.7030 28Cr4 1.5710 36NiCr6, 1.7035 41Cr4, 1.7225 42CrMo4 1.2080 X210Cr12, 1.2083 X42Cr13, 1.2419 105WCr6, 1.2379 X155CrVMo12-1 1.3243 S 6-5-2-5, 1.3343 S 6-5-2, 1.3344 S 6-5-3 Spring steel = 1.5026 55Si7, 1.7176 55Cr3, 1.8159 51CrV4	850-1.400 N/mm <sup>2</sup>	2/3 Flute	Slotting	90	0.011	0.021	0.028	0.039	0.047	0.060	0.080	0.100
		3/4 Flute	Roughing	110	0.012	0.024	0.032	0.045	0.054	0.070	0.090	0.110
		4 Flute	Finishing	180	0.012	0.023	0.031	0.043	0.051	0.070	0.090	0.110
<b>Hardened steel</b> Tool steel, heat-treatable steel, spring steel, high-speed steel, case hardened steel, etc. Z.B.: 1.2344 X40CrMoV5-1; 1.2767 X45NiCrMo4; 1.2379 X155CrVMo12-1; 1.2080 X210Cr12 1.3343 S 6-5-2	up to 54 HRC	2/3 Flute	Slotting	35	0.007	0.013	0.018	0.024	0.029	0.040	0.050	0.060
		3/4 Flute	Roughing	50	0.009	0.017	0.023	0.031	0.037	0.050	0.060	0.080
		4 Flute	Finishing	70	0.007	0.013	0.018	0.024	0.029	0.040	0.050	0.060
<b>Stainless steel</b> 1.4104 X14CrMoS17, 1.4105 X6CrMoS17, 1.4305 X10CrNiS18-9 USA = 303, 410, 420F, 430, 430F	up to 750 N/mm <sup>2</sup>	2/3 Flute	Slotting	80	0.008	0.017	0.022	0.030	0.036	0.050	0.060	0.080
		3/4 Flute	Roughing	100	0.009	0.019	0.026	0.035	0.041	0.060	0.070	0.090
		4 Flute	Finishing	160	0.009	0.018	0.025	0.033	0.040	0.050	0.070	0.080
<b>Stainless steel</b> 1.4301X5CrNi18-10, 1.4303 X5CrNi18-12 1.4310 XCrNi18-8 USA = 304, 304L, 420	750-850 N/mm <sup>2</sup>	2/3 Flute	Slotting	55	0.007	0.014	0.019	0.027	0.032	0.040	0.050	0.070
		3/4 Flute	Roughing	70	0.008	0.017	0.022	0.031	0.037	0.050	0.060	0.080
		4 Flute	Finishing	110	0.008	0.016	0.021	0.030	0.036	0.050	0.060	0.070
<b>Stainless steel</b> 1.4438 X2CrNiMo18-15-4, 1.4404 X2CrNiMo17-12-2, 1.4571 X6CrNiTi18-10 USA = 310, 316, 316B, 316L, 317	above 850 N/mm <sup>2</sup>	2/3 Flute	Slotting	50	0.006	0.013	0.017	0.024	0.029	0.040	0.050	0.060
		3/4 Flute	Roughing	70	0.008	0.015	0.020	0.029	0.035	0.050	0.060	0.070
		4 Flute	Finishing	100	0.006	0.013	0.017	0.024	0.029	0.040	0.050	0.060
<b>Special alloys (nickel based "Ni")</b> Nimonic, Inconel, Monel, Hastelloy	up to 1.300 N/mm <sup>2</sup>	2/3 Flute	Slotting	25	0.005	0.009	0.012	0.018	0.022	0.030	0.040	0.050
		3/4 Flute	Roughing	40	0.005	0.011	0.014	0.022	0.026	0.030	0.040	0.050
		4 Flute	Finishing	50	0.005	0.009	0.012	0.018	0.022	0.030	0.040	0.050
<b>Titanium alloys ("Ti")</b> 3.7024 Ti99.5, 3.7114 TiAl5Sn2.5, 3.7124 TiCu2 3.7154 TiAl6Zr5, 3.7164 TiAl6V4, 3.7184 TiAl4Mo4Sn2.5	up to 1.300 N/mm <sup>2</sup>	2/3 Flute	Slotting	40	0.008	0.017	0.022	0.030	0.036	0.050	0.060	0.080
		3/4 Flute	Roughing	50	0.010	0.020	0.027	0.036	0.043	0.060	0.070	0.090
		4 Flute	Finishing	80	0.009	0.018	0.025	0.033	0.040	0.050	0.070	0.080
<b>Cast iron, grey cast iron, spheroidal graphite and malleable cast iron</b> 0.6010 EN-GL100 (GG10), 0.6020 EN-GJL-200 (GG20), 0.7050 EN-GJS-500-7 (GGG50), 0.8535 EN-GJMW-350-4 (GTW35)	up to 240 HB 30	2/3 Flute	Slotting	110	0.011	0.022	0.030	0.039	0.047	0.060	0.080	0.100
		3/4 Flute	Roughing	130	0.013	0.026	0.034	0.045	0.054	0.070	0.090	0.110
		4 Flute	Finishing	220	0.012	0.024	0.033	0.043	0.051	0.070	0.090	0.110
<b>Cast iron, grey cast iron, spheroidal graphite and malleable cast iron</b> 0.6025 EN-GL250 (GG25), 0.6035 EN-GJL-350 (GG35), 0.7070 EN-GJS-700-2 (GGG70), 0.8170 EN-GJMB-700-2 (GTS70)	above 240 HB 30	2/3 Flute	Slotting	95	0.009	0.019	0.025	0.033	0.040	0.050	0.070	0.080
		3/4 Flute	Roughing	110	0.011	0.021	0.029	0.038	0.046	0.060	0.080	0.090
		4 Flute	Finishing	190	0.010	0.020	0.027	0.036	0.044	0.060	0.070	0.090
<b>Aluminum, Al-wrought alloys, Al-alloys</b> 3.0255 Al99.5, 3.2315 AlMgSi1, 3.3515 AlMg1 3.0615 AlMgSiPb, 3.1325 AlCuMg1, 3.3245 AlMg3Si, 3.4365 AlZnMgCu1.5	up to 3% Si	2/3 Flute	Slotting	300	0.019	0.037	0.050	0.065	0.078	0.100	0.130	0.160
		2/3 Flute	Roughing	350	0.021	0.043	0.057	0.075	0.090	0.120	0.150	0.190
		3/4 Flute	Finishing	600	0.020	0.041	0.055	0.072	0.086	0.110	0.140	0.180
<b>Aluminum-cast alloys</b> 3.2131 G-AlSi5Cu1, 3.2153 G-AlSi7Cu3, 3.2573 G-AlSi9 3.2581 G-AlSi12, 3.2583 G-AlSi12Cu, - G-AlSi12CuNiMg	above 3% Si	2/3 Flute	Slotting	160	0.016	0.031	0.042	0.056	0.067	0.090	0.110	0.140
		2/3 Flute	Roughing	190	0.018	0.036	0.048	0.064	0.077	0.100	0.130	0.160
		3/4 Flute	Finishing	320	0.017	0.034	0.046	0.062	0.074	0.100	0.120	0.150
<b>Magnesium-alloys</b> MgMn2, G-MgAl8Zn1, G-MgAl6Zn3	-	2/3 Flute	Slotting	125	0.016	0.031	0.042	0.056	0.067	0.090	0.110	0.140
		2/3 Flute	Roughing	210	0.018	0.036	0.048	0.064	0.077	0.100	0.130	0.160
		3/4 Flute	Finishing	360	0.017	0.034	0.046	0.062	0.074	0.100	0.120	0.150
<b>Non-ferrous metals (copper, short- or long-chipping brass or bronze)</b> 2.0070 SE-Cu, 2.1020 CuSn6, 2.1096 G-CuSn5ZnPb 2.0380 CuZn39Pb2, 2.0401 CuZn39Pb3, 2.0410 CuZn43Pb2 2.0250 CuZn20, 2.0280 CuZn33, 2.0332 CuZn37Pb0.5 2.1090 CuSn7ZnPb, 2.1170 CuPb5Sn5, 2.1176 CuPb10Sn 2.0916 CuAl5, 2.0960 CuAl9Mn, 2.1050 CuSn10	up to 850 N/mm <sup>2</sup>	2/3 Flute	Slotting	175	0.013	0.025	0.034	0.046	0.055	0.070	0.090	0.120
		2/3 Flute	Roughing	290	0.014	0.029	0.039	0.053	0.063	0.080	0.110	0.130
		3/4 Flute	Finishing	500	0.014	0.028	0.037	0.051	0.061	0.080	0.100	0.130

All recommendations are valid for coated tools. For bright milling cutters please vc - 40% and fz -25%

What lasts long is good

# Sustainability & certifications

Whether during machining, coating or refurbishing:

Solutions from Guhring revolve around reducing the requirement and increasing the performance at the same time.

Longevity and a lower consumption of resources, be it operating materials, energy or raw materials, ultimately mean reduced pollutant emission, more efficient production, lower process costs and improved sustainability.

Pre-requisite for these successes is the high priority Guhring attaches to the best possible quality of its products and services.







# STEEL MACHINING



*Strong in steel*

# RT 100

RT 100 S was developed for the complex **machining of steel materials**.

It makes a strong impression with its high cutting speeds and consistently good hole quality. An especially stable and accurate cutting edge is produced thanks to the **special micro-geometry**.

The extremely **smooth surface finish** of the RT 100 S web thinning and flute profile reduces the friction between drill and chip. The machining temperature is reduced and chip evacuation improved. Cutting forces are reduced. These tool features result in **excellent hole quality** and **tool life**.



# S

## **The ideal tool for applications in:**

structural and free-cutting steels  
alloyed and unalloyed heat-treatable steels  
alloyed and unalloyed case hardened steels  
tool steels and high speed steels

## **Maximum performance thanks to premium tool quality:**

- long and consistent tool life minimizes tooling costs and reduces machine down-time
- optimal component quality
- high cutting parameters ensure short machining times as well as a reduction in "cost per part"

# GUHRING Series No. Index

Series No.	Page	Description	Surface Finish
495	268	Front/back de-burrer	nano-A™
3011	236	UNI PRO extra long length end mills (2-fluted), metric	bright
3012	251	UNI PRO XL end mills (4-fluted), metric	bright
3014	256	UNI PRO extra long length ball nose end mills (2-fluted), metric	bright
3015	261	UNI PRO XL ball nose end mills (4-fluted), metric	bright
3019	192	FINISH-TECH / GH 100 U standard length multi-flute end mills, metric	bright
3021	236	UNI PRO extra long length end mills (2-fluted), metric	FIREX®
3023	251	UNI PRO XL end mills (4-fluted), metric	FIREX®
3024	253	UNI PRO standard length ball nose end mills (2-fluted), metric	bright
3030	256	UNI PRO XL ball nose end mills (2-fluted), metric	FIREX®
3043	261	UNI PRO XL ball nose end mills (4-fluted), metric	FIREX®
3047	192	FINISH-TECH / GH 100 U standard length multi-flute end mills, metric	FIREX®
3049	254	UNI PRO standard length ball nose end mills (2-fluted), metric	FIREX®
3053	95	RF 100 VA variable helix end mills (4-fluted)	nano-Si®
3059	163	ALUMI-TECH standard length end mills (2-fluted), metric	bright
3060	107	RF 100 VA/NF variable helix end mills (4-fluted)	nano-Si®
3077	112	RF 100 A standard length variable helix end mills for aluminum	bright
3078	88	RF 100 F standard length variable helix end mills for materials < 30 HRC	FIREX®
3079	63	RF 100 U standard length variable helix end mills, corner radius, for materials < 54 HRC	FIREX®
3080	94	RF 100 VA standard length variable helix end mills for stainless steels	nano-A™
3081	106	RF 100 VA/NF standard length variable helix roughing-finishing end mills for stainless steels	nano-A™
3082	82	RF 100 U/HF std. length variable helix roughing-finishing end mills, for materials < 54 HRC	FIREX®
3084	189	FINISH-TECH 50 / GH 100 U end mills (6-fluted)	nano-Si®
3086	155	AERO-TECH / GH 100 U stub length end mills (3-fluted)	FIREX®
3087	231	UNI PRO "R" standard length end mills (2-fluted), corner radius	FIREX®
3088	235	UNI PRO "R" long length end mills (2-fluted), corner radius	FIREX®
3089	245	UNI PRO "R" standard length end mills (4-fluted), corner radius	FIREX®
3090	250	UNI PRO "R" XL end mills (4-fluted), corner radius	FIREX®
3091	190	FINISH-TECH 50 / GH 100 U standard length multi-flute end mills, corner radius	FIREX®
3092	228	UNI PRO stub length end mills (2-fluted)	FIREX®
3093	242	UNI PRO stub length end mills (4-fluted)	FIREX®
3095	78	RF 50 stub length variable flute end mills (4-fluted)	FIREX®
3096	79	RF 50 standard length variable flute end mills (4-fluted)	FIREX®
3097	173	AERO-ROUGH 48 / RS 100 U standard length end mills	FIREX®
3098	175	AERO-ROUGH 56 / RS 100 F standard length end mills	FIREX®
3099	60	RF 100 U stub length variable helix end mills for materials < 54 HRC	FIREX®
3100	62	RF 100 U standard length variable helix end mills for materials < 54 HRC	FIREX®
3101	222	TRACE-TECH / GF 300 B standard length ball nose	FIREX®
3106	233	UNI PRO "R" standard length end mills (2-fluted), corner radius	bright
3111	247	UNI PRO "R" standard length end mills (4-fluted), corner radius	bright
3112	193	GH 100 U standard length multi-flute end mills, corner radius, metric	bright
3113	60	RF 100 U stub length variable helix end mills for materials < 54 HRC	FIREX®
3114	62	RF 100 U standard length variable helix end mills for materials < 54 HRC	FIREX®
3115	136	RF 100 SF standard length 6-flute variable helix end mills for materials < 54 HRC	FIREX®
3126	161	ALUMI-TECH standard length end mills (2-fluted), metric	bright
3127	170	ROUGH-TECH ALU / GS 100 A standard length end mills, coarse tooth, metric	bright
3146	230	UNI PRO standard length end mills (2-fluted)	bright
3147	234	UNI PRO long length end mills (2-fluted)	bright
3148	230	UNI PRO standard length end mills (2-fluted)	FIREX®
3149	234	UNI PRO long length end mills (2-fluted)	FIREX®

# GUHRING Series No. Index

Series No.	Page	Description	Surface Finish
3150	244	UNI PRO standard length end mills (4-fluted)	bright
3151	249	UNI PRO XL end mills (4-fluted)	bright
3152	248	UNI PRO long length end mills (4-fluted),	bright
3153	244	UNI PRO standard length end mills (4-fluted)	FIREX®
3155	249	UNI PRO XL end mills (4-fluted)	FIREX®
3156	248	UNI PRO long length end mills (4-fluted)	FIREX®
3157	252	UNI PRO standard length ball nose end mills (2-fluted)	bright
3158	255	UNI PRO long length ball nose end mills (2-fluted)	bright
3159	252	UNI PRO standard length ball nose end mills (2-fluted)	FIREX®
3160	255	UNI PRO long length ball nose end mills (2-fluted)	FIREX®
3161	257	UNI PRO standard length ball nose end mills (4-fluted)	bright
3162	260	UNI PRO XL ball nose end mills (4-fluted)	bright
3164	259	UNI PRO long length ball nose end mills (4-fluted)	bright
3165	257	UNI PRO standard length ball nose end mills (4-fluted)	FIREX®
3166	260	UNI PRO XL ball nose end mills (4-fluted)	FIREX®
3167	259	UNI PRO long length ball nose end mills (4-fluted)	FIREX®
3168	238	UNI PRO standard length end mills (3-fluted)	bright
3169	240	UNI PRO XL end mills (3-fluted)	bright
3170	238	UNI PRO standard length end mills (3-fluted)	FIREX®
3171	240	UNI PRO XL end mills (3-fluted)	FIREX®
3172	158	AERO-TECH / GH 100 A standard length end mills (3-fluted)	bright
3173	158	AERO-TECH / GH 100 U standard length end mills (3-fluted)	FIREX®
3174	162	ALUMI-TECH standard length end mills (2-fluted)	bright
3175	164	ALUMI-TECH long length end mills (2-fluted)	bright
3177	167	ALUMI-TECH / GA 200 A long length end mills (3-fluted)	FIREX®
3178	188	FINISH-TECH / GH 100 U standard length multi-flute end mills	bright
3179	188	FINISH-TECH / GH 100 U standard length multi-flute end mills	FIREX®
3180	194	FINISH-TECH / GH 100 U long length multi-flute end mills	bright
3181	194	FINISH-TECH / GH 100 U long length multi-flute end mills	FIREX®
3182	199	FINISH-TECH / GH 100 H standard length multi-flute end mills	nano-Si®
3183	201	FINISH-TECH / GH 100 H long length multi-flute end mills	nano-Si®
3184	169	ROUGH-TECH ALU / GS 100 A standard length end mills, coarse tooth	bright
3186	179	ROUGH-TECH 48 / GS 100 U standard length end mills, fine tooth	bright
3188	180	ROUGH-TECH 48 / GS 100 U standard length end mills, fine tooth	FIREX®
3189	184	ROUGH-TECH 54 / GS 100 H standard length end mills, fine tooth	FIREX®
3190	186	ROUGH-TECH 54 / GS 100 H long length end mills, fine tooth	FIREX®
3191	224	TRACE-TECH / GF 300 B long length ball nose	FIREX®
3192	220	TRACE-TECH / GF 300 T long length cutters, Torus	nano-Si®
3202	113	RF 100 A standard length variable helix end mills for aluminum, metric	bright
3203	159	AERO-TECH / GH 100 U standard length end mills (3-fluted), metric	bright
3204	181	ROUGH-TECH 48 / GS 100 U standard length end mills, fine tooth, metric	bright
3303	232	UNI PRO standard length end mills (2-fluted)	bright
3304	246	UNI PRO standard length end mills (4-fluted)	bright
3306	258	UNI PRO standard length ball nose end mills (4-fluted), metric	bright
3307	239	UNI PRO standard length end mills (3-fluted), metric	bright
3308	253	UNI PRO standard length ball nose end mills (2-fluted), metric	bright
3309	163	ALUMI-TECH standard length end mills (2-fluted), metric	bright
3310	161	ALUMI-TECH standard length end mills (2-fluted), metric	bright
3311	191	FINISH-TECH / GH 100 U standard length multi-flute end mills, metric	bright
3312	195	FINISH-TECH / GH 100 U XL multi-flute end mills, metric	bright

# GUHRING Series No. Index

Series No.	Page	Description	Surface Finish
3313	196	UNI PRO XL end mills (3-fluted), metric	bright
3314	241	UNI PRO XL end mills (3-fluted), metric	bright
3319	113	RF 100 A standard length variable helix end mills for aluminum, metric	bright
3358	165	ALUMI-TECH long length end mills (2-fluted), metric	bright
3359	223	TRACE-TECH / GF 300 B standard length ball nose, metric	nano-Si®
3360	225	TRACE-TECH / GF 300 B XL ball nose, metric	nano-Si®
3361	219	TRACE-TECH / GF 300 T hard profile cutters, Torus, metric	nano-Si®
3362	221	TRACE-TECH / GF 300 T XL hard profile cutters, Torus, metric	nano-Si®
3364	170	ROUGH-TECH ALU / GS 100 A standard length, coolant fed end mills, coarse tooth, metric	bright
3365	182	ROUGH-TECH 48 / GS 100 U standard length, coolant fed end mills, fine tooth, metric	FIREX®
3366	90	RF 100 F standard length variable helix end mills, coolant through, metric	FIREX®
3367	166	ALUMI-TECH / GA 200 A standard length, coolant fed end mills (3-fluted), metric	bright
3396	263	Chamfering milling cutters - 90°	TiAlN
3468	123	RF 100 A/WF standard length variable helix rougher for aluminum, metric	bright
3469	123	RF 100 A/WF standard length variable helix rougher for aluminum, metric	bright
3470	124	RF 100 A/WF long length variable helix rougher for aluminum, metric	bright
3471	124	RF 100 A/WF long length variable helix rougher for aluminum, metric	bright
3472	115	RF 100 A 3-Flute variable helix end mills	bright
3473	117	RF 100 A 3-Flute variable helix end mills, metric	bright
3498	129	RF 100 Ti standard length variable helix end mills, corner radius, for titanium alloys, metric	Super-A™
3499	129	RF 100 Ti standard length variable helix end mills, corner radius, for titanium alloys, metric	Super-A™
3507	83	RF 100 U/HF standard lgth variable helix roughing-finishing for materials < 54 HRC, metric	FIREX®
3508	83	RF 100 U/HF std. lgth variable helix roughing-finishing, for materials < 54 HRC, metric	FIREX®
3509	85	RF 100 U/HF long length variable helix roughing-finishing, for materials < 54 HRC, metric	FIREX®
3522	85	RF 100 U/HF long length variable helix roughing-finishing, for materials < 54 HRC, metric	FIREX®
3540	156	AERO-TECH / GH 100 U stub length end mills (3-fluted), metric	FIREX®
3558	237	UNI PRO stub length end mills (3-fluted), metric	FIREX®
3561	233	UNI PRO "R" standard length end mills (2-fluted), corner radius, metric	FIREX®
3562	247	UNI PRO "R" standard length end mills (4-fluted), corner radius, metric	FIREX®
3563	193	GH 100 U standard length multi-flute end mills, corner radius, metric	FIREX®
3598	86	RF 100 U/HF extra long variable helix roughing-finishing end mills, metric	FIREX®
3600	86	RF 100 U/HF extra long variable helix roughing-finishing, for materials < 54 HRC, metric	FIREX®
3627	72	RF 100 U long length variable helix end mills for materials < 54 HRC, metric	FIREX®
3629	89	RF 100 F standard length variable helix end mills for materials < 30 HRC, metric	FIREX®
3630	89	RF 100 F standard length variable helix end mills for materials < 30 HRC, metric	FIREX®
3631	137	RF 100 SF standard length 6-flute variable helix end mills for materials < 54 HRC, metric	FIREX®
3632	137	RF 100 SF standard length 6-flute variable helix end mills for materials < 54 HRC, metric	FIREX®
3633	229	UNI PRO stub length end mills (2-fluted), metric	FIREX®
3634	229	UNI PRO stub length end mills (2-fluted), metric	FIREX®
3637	243	UNI PRO stub length end mills (4-fluted), metric	FIREX®
3676	232	UNI PRO standard length end mills (2-fluted), metric	FIREX®
3677	239	UNI PRO standard length end mills (3-fluted), metric	FIREX®
3678	246	UNI PRO standard length end mills (4-fluted), metric	FIREX®
3679	254	UNI PRO standard length ball nose end mills (2-fluted), metric	FIREX®
3680	241	UNI PRO XL end mills (3-fluted), metric	FIREX®
3682	185	ROUGH-TECH 54 / GS 100 H standard length end mills, fine tooth, metric	nano-Si®
3689	191	FINISH-TECH / GH 100 U standard length multi-flute end mills, metric	FIREX®
3691	195	FINISH-TECH / GH 100 U XL multi-flute end mills, metric	FIREX®
3693	196	FINISH-TECH / GH 100 U XL multi-flute end mills, metric	FIREX®
3696	108	RF 100 VA/NF std. lgth variable helix roughing/finishing end mills for stainless steels, metric	nano-A™

# GUHRING Series No. Index

Series No.	Page	Description	Surface Finish
3715	200	FINISH-TECH / GH 100 H standard length multi-flute end mills, metric	nano-Si®
3716	202	FINISH-TECH / GH 100 H long length multi-flute end mills, metric	nano-Si®
3718	108	RF 100 VA/NF std. lgth variable helix roughing/finishing end mills for stainless steels, metric	nano-A™
3719	237	UNI PRO stub length end mills (3-fluted), metric	FIREX®
3721	243	UNI PRO stub length end mills (4-fluted), metric	FIREX®
3723	181	ROUGH-TECH 48 / GS 100 U standard length end mills, fine tooth, metric	FIREX®
3727	258	UNI PRO standard length ball nose end mills (4-fluted), metric	FIREX®
3729	156	AERO-TECH / GH 100 U stub length end mills (3-fluted), metric	FIREX®
3731	61	RF 100 U stub length variable helix end mills for materials < 54 HRC, metric	FIREX®
3732	64	RF 100 U standard length variable helix end mills for materials < 54 HRC, metric	FIREX®
3733	110	RF 100 VA/NF long length variable helix roughing/finishing end mills, metric	nano-A™
3736	64	RF 100 U standard length variable helix end mills for materials < 54 HRC, metric	FIREX®
3741	159	AERO-TECH / GH 100 U standard length end mills (3-fluted), metric	FIREX®
3800	96	RF 100 VA standard length variable helix end mills for stainless steels, metric	nano-A™
3803	96	RF 100 VA standard length variable helix end mills for stainless steels, metric	nano-A™
3804	93	RF 100 VA stub length variable helix end mills for stainless steels, metric	nano-A™
3805	93	RF 100 VA stub length variable helix end mills for stainless steels, metric	nano-A™
3806	100	RF 100 VA long length variable helix end mills for stainless steels, metric	nano-A™
3807	100	RF 100 VA long length variable helix end mills for stainless steels, metric	nano-A™
3837	68	RF 100 U long length variable helix end mills w/reduced neck for materials < 54 HRC, metric	FIREX®
3838	68	RF 100 U long length variable helix end mills w/reduced neck for materials < 54 HRC, metric	FIREX®
3839	70	RF 100 U long length variable helix end mills for materials < 54 HRC, metric	FIREX®
3848	211	GF 500 B HSC standard length ball nose profile cutters, metric	nano-Si®
3849	214	GF 500 B HSC XL ball nose profile cutters, metric	nano-Si®
3853	215	GF 500 B HSC XL ball nose profile cutters, metric	nano-Si®
3854	210	GF 500 B HSC standard length ball nose profile cutters, metric	nano-Si®
3855	213	GF 500 B HSC long length ball nose profile cutters, metric	nano-Si®
3856	205	GF 500 T HSC standard length profile cutters with Torus form, metric	nano-Si®
3859	206	GF 500 T HSC XL profile cutters with Torus form, metric	nano-Si®
3860	209	GF 500 T HSC XL profile cutters with Torus form, Metric	nano-Si®
3863	208	GF500 T 2-flute, Torus form	nano-Si®
3865	207	GF500 T 2-flute, Torus form, Metric	nano-Si®
3866	212	GF500 B 2-flute, Ball nose, Metric	nano-Si®
3867	140	PCD Center cutting end mills (2-flute)	bright
3870	141	PCD Center cutting end mills (3-flute)	bright
3871	70	RF 100 U 4-Flute, Variable helix, Metric	FIREX®
3872	65	RF 100 U 4-Flute, Variable helix, Metric	FIREX®
3873	65	RF 100 U 4-Flute, Variable helix, Metric	FIREX®
3874	162	GA 200 A 2-flute, ALUMI-TECH	bright
3875	164	GA 200 A 2-flute, ALUMI-TECH	Super-A™
3876	128	RF 100 Ti 4-flute, Variable helix	Super-A™
3877	167	GA 200 A 3-flute, ALUMI-TECH	Super-A™
3884	169	GS 100 A 3-flute, ROUGH-TECH ALU, rougher	Super-A™
3885	110	RF 100 VA/NF, Variable helix rougher, 4-flute	nano-A™
3886	180	GS100 U 4/5-flute, ROUGH-TECH 48, rougher	Super-A™
3887	174	RS 100 U 4/5-flute, AERO-ROUGH 48, rougher, Metric	FIREX®
3888	174	RS 100 U 4/5-flute, AERO-ROUGH 48, rougher, Metric	FIREX®
3889	176	RS 100 F 5/6-flute, AERO-ROUGH 56, rougher, Metric	FIREX®
3890	176	RS 100 F 5/6-flute, AERO-ROUGH 56, rougher, Metric	FIREX®
3891	76	RF 100 U 3-Flute, Variable helix, Metric	FIREX®

# GUHRING Series No. Index

Series No.	Page	Description	Surface Finish
3892	76	RF 100 U 3-Flute, Variable helix, Metric	FIREX®
3893	75	RF 100 U 3-Flute, Variable helix, Metric	FIREX®
3894	75	RF 100 U 3-Flute, Variable helix, Metric	FIREX®
3895	126	RF 100 H 4-Flute, Variable helix, Metric	nano-Si®
3896	126	RF 100 H 4-Flute, Variable helix, Metric	nano-Si®
3897	135	RF 100 S/F 5-Flute, Variable helix, Metric	FIREX®
3898	135	RF 100 S/F 5-Flute, Variable helix, Metric	FIREX®
4250	66	RF 100 U 4-Flute, Variable helix	FIREX®
4251	67	RF 100 U 4-Flute, Variable helix	FIREX®
4252	69	RF 100 U 4-Flute, Variable helix	FIREX®
4253	71	RF 100 U 4-Flute, Variable helix	FIREX®
4254	73	RF 100 U 3-Flute, Variable helix	FIREX®
4255	74	RF 100 U 3-Flute, Variable helix	FIREX®
4256	84	RF 100 U/HF 4-Flute, Variable helix rougher	FIREX®
4257	92	RF 100 VA 4-Flute, Variable helix square,	nano-A™
4258	99	RF 100 VA 4-Flute, Variable helix square,	nano-A™
4259	101	RF 100 VA 4-Flute, Variable helix square,	nano-A™
4260	98	RF 100 VA 4-Flute, Variable helix square,	nano-A™
4261	102	RF 100 VA 4-Flute, Variable helix ball nose	nano-A™
4262	109	RF 100 VA/NF 4-flute, Variable helix rougher	nano-A™
4263	132	RF 100 S/F 5-flute, Variable helix	FIREX®
4264	134	RF 100 S/F 5-flute, Variable helix	FIREX®
4265	114	RF 100 A 3-Flute, Variable helix	bright
4266	122	RF 100 A/WF 3-Flute, Variable helix	bright
5492	142	DL 100 X2 Center cutting end mills (2-flute)	bright
5493	143	DL 100 X2 Center cutting end mills (2-flute)	bright
5495	144	PCD Slot Drills (3-flute) Coolant Fed	bright
5496	145	PCD Slot Drills (3-flute) Coolant Fed	bright
6700	97	RF 100 VA 4-Flute, Variable helix square, Metric	nano-A™
6701	97	RF 100 VA 4-Flute, Variable helix square, Metric	nano-A™
6702	115	RF 100 A 3-Flute, Variable helix	bright
6703	117	RF 100 A 3-Flute, Variable helix	bright
6706	61	RF 100 U 4-Flute, Variable helix	FIREX®
6707	103	RF 100 VA 4-Flute, Variable helix ball nose, Metric	nano-A™
6708	103	RF 100 VA 4-Flute, Variable helix ball nose, Metric	nano-A™
6709	133	RF 100 S/F 5-Flute, Variable helix	FIREX®
6710	133	RF 100 S/F 5-Flute, Variable helix	FIREX®
6711	262	Chamfering milling cutters - 60°	TiAlN
6712	262	Chamfering milling cutters - 60°	TiAlN
6713	263	Chamfering milling cutters - 90°	TiAlN
6714	265	Chamfering milling cutters - 120°	TiAlN
6715	265	Chamfering milling cutters - 120°	TiAlN
6717	148	CR 100 multi-flute slotting carbide router	Diamond
6718	149	CR 100 multi-flute slotting carbide router, coolant fed	Diamond
6719	150	CR 100 multi-flute plunging carbide router	Diamond
6720	151	CR 100 multi-flute plunging carbide router	Diamond
6729	116	RF 100 A 3-Flute, Metric, corner radius	bright
6730	118	RF 100 A 3-Flute, Metric, XL Long Length (3xD)	bright
6731	118	RF 100 A 3-Flute, Metric, XL Long Length (3xD)	bright
6732	119	RF 100 A 3-Flute, Metric, XL Long Length (4xD)	bright

# GUHRING Series No. Index

Series No.	Page	Description	Surface Finish
6733	119	RF 100 A 3-Flute, Metric, XL Long Length (4xD)	bright
6734	120	RF 100 A 3-Flute, Metric, XL Long Length (5xD)	bright
6735	120	RF 100 A 3-Flute, Metric, XL Long Length (5xD)	bright
6736	45	Ratio end mills RF 100 DIVER	nano-Si <sup>®</sup>
6737	45	Ratio end mills RF 100 DIVER	nano-Si <sup>®</sup>
6757	42	Ratio end mills RF 100 DIVER	nano-Si <sup>®</sup>
6759	43	Ratio end mills RF 100 DIVER	nano-Si <sup>®</sup>
6760	49	Ratio end mills RF 100 SPEED	Super-A <sup>™</sup>
6761	51	Ratio end mills RF 100 SPEED	Super-A <sup>™</sup>
6762	55	Ratio end mills RF 100 A 90°	bright
6763	57	Ratio end mills RF 100 A 90°	nano-A <sup>™</sup>
6764	58	Ratio end mills RF 100 A 90°	nano-A <sup>™</sup>
6765	49	Ratio end mills RF 100 SPEED	Super-A <sup>™</sup>
6766	51	Ratio end mills RF 100 SPEED	Super-A <sup>™</sup>
6771	216	High Feed HF 300 (4-Flute)	nano-Si <sup>®</sup>
6772	217	High Feed HF 300 (4-Flute)	nano-Si <sup>®</sup>
6773	48	Ratio end mills RF 100 SPEED	nano-A <sup>™</sup>
6774	50	Ratio end mills RF 100 SPEED	nano-A <sup>™</sup>
6775	52	Ratio end mills RF 100 A 90°	bright
6776	56	Ratio end mills RF 100 A 90°	nano-A <sup>™</sup>
6784	264	Chamfering milling cutters - 90°	TiAlN
6785	264	Chamfering milling cutters - 90°	TiAlN
6786	266	Chamfering milling cutters - 90°, 6-flute	TiAlN
6787	266	Chamfering milling cutters - 90°, 6-flute	TiAlN
6788	267	Corner rounding milling cutters	FIREX <sup>®</sup>
6797	38	Ratio end mills RF 100 DIVER, 3-flute, metric	nano-Si <sup>®</sup>
6798	38	Ratio end mills RF 100 DIVER, 3-flute, metric	nano-Si <sup>®</sup>
6799	39	Ratio end mills RF 100 DIVER, 3-flute with coolant through, metric	nano-Si <sup>®</sup>
6800	39	Ratio end mills RF 100 DIVER, 3-flute with coolant through, metric	nano-Si <sup>®</sup>
6801	46	Ratio end mills RF 100 DIVER, 4-flute with coolant through, metric	nano-Si <sup>®</sup>
6802	46	Ratio end mills RF 100 DIVER, 4-flute with coolant through, metric	nano-Si <sup>®</sup>
6803	41	Ratio end mills RF 100 DIVER, 4-flute, stub length, metric	nano-Si <sup>®</sup>
6804	41	Ratio end mills RF 100 DIVER, 4-flute, stub length, metric	nano-Si <sup>®</sup>
6872	36	Ratio end mills RF 100 DIVER, 3-flute, inch	nano-Si <sup>®</sup>
6873	37	Ratio end mills RF 100 DIVER, 3-flute with coolant through, inch	nano-Si <sup>®</sup>
6874	40	Ratio end mills RF 100 DIVER, 4-flute, stub length, inch	nano-Si <sup>®</sup>
6875	44	Ratio end mills RF 100 DIVER, 4-flute with coolant through, inch	nano-Si <sup>®</sup>



# Quote Request Form

Distributor/customer name

Address

Telephone

Date

If a distributor inquiry list end user name, city, & state

City, Zip code

Email

Name of contact

Enquiry  Order

(Please enter the required parameters into the boxes)

Reference tool / basic tool (Art.-No.)

**1** Dimensions

Shank length

Reach

Flute length

No. of cutting edges

Shank-Ø

Neck Ø

Step Ø\*

Nom. Ø

Cutting edge length and angle\*

Chamfer/radius see 3

Total length

Shank form see 2

with internal cooling  \* only with step milling cutters

**2** Shank form

Plain shank  Flatted shank  Whistle Notch

**3** Chamfer/radius

Chamfer  Corner radius  Ball nose  Size

**4** Geometry

Type N, W, H  Type NF  Type NRf, HR  Type WR

**5** Material Coating

Solid carbide  HSS M42  HSS-PM  other: \_\_\_\_\_

Bright  SuperA-coated  A-coated  FIRE-coated

**6** Operation

Slotting  Roughing  Finishing  Tracing

Depth of cut: \_\_\_\_\_

Width of cut: \_\_\_\_\_

**7** Application

Workpiece material:

Hardness:

**8** Required quantity:

# GUHRING



DRILLING

TAPPING/  
THREADMILLING/  
FLUTELESS TAPPING

MILLING

REAMING

PCD/PCBN



SPECIAL TOOLING  
SOLUTIONS

COUNTERSINKING/  
DE-BURRING

MODULAR TOOLING  
SYSTEMS

TOOL RECONDITIONING SERVICE

**Guhring, Inc. Main Office**

1445 Commerce Avenue  
Brookfield, WI 53045  
Tel (262) 784-6730 (800) 776-6170  
Fax (262) 784-9096

**East Coast Reconditioning Facility**

121 W Dudley Town Rd.  
Bloomfield, CT 06002

**West Coast Distribution Center and  
Reconditioning Facility**

15581 Computer Ln  
Huntington Beach, CA 92649

**Michigan Manufacturing and  
Reconditioning Facility**

24875 Trans-X Road  
Novi, MI 48375

**Guhring Corp. (Canada)**

20 Steckle Place, Unit #14  
Kitchener, ON N2E 2C3  
Tel (519) 748-9664 (800) 463-5555  
Fax (519) 748-2954